

X5G *GYROSCOPE 2.4G* **EXPLORERS**

4CH 2.4G REMOTE CONTROL QUADCOPTER

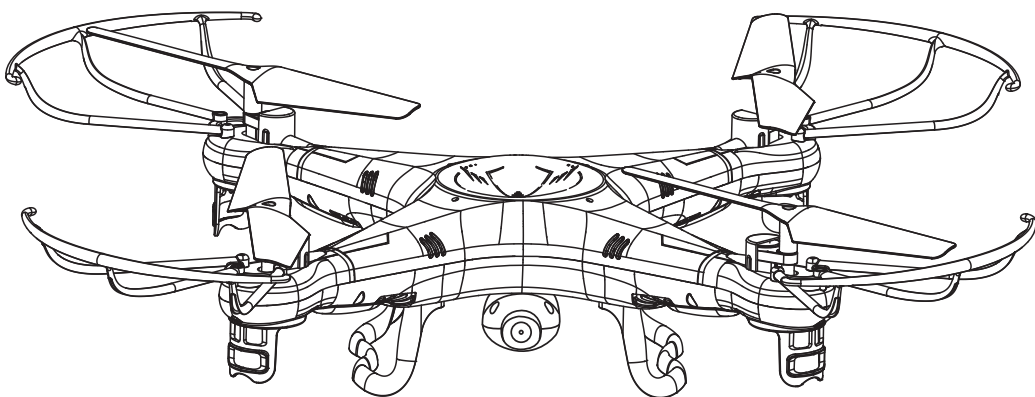

1 INSTRUCTION MANUAL

IMPLEMENT STANDARD: GB/T26701-2011

Key features of quadcopter

- Four-axis struture makes the quadcopter more flexible and rapid when flying. It is wind-resistant and can be flown indoor or outdoor.
- Built-in 6 axis gyroscope for precise hovering in the sky.
- Simple modular design makes changing parts easy.
- With 360° 3D eversion and throwing flight function.

The materials and specification mentioned in this instruction manual or the parts inside this package are for reference only. Any updated or changed please refer to our website: www.symatoys.com

PREFACE

Dear Customers:

Thank you for purchasing our flying model. Please read this instruction manual carefully in order to master the skill more quickly and operate this product more safely. In the mean time, please well keep the original of this instruction manual for future reference.

IMPORTANT INSTRUCTION

1. This product is not a toy but a precise equipment that integrating mechanics and electronics with expertise of aerodynamics and high-frequency transmitting. It requires to be correctly assembled and debugged so as to prevent the accident from being happened. The product owner should operate or control it in safe way. Please noted that we won't take any responsibility for any wrong operation as this may result in severe injury or loss of property and we can not control the operating process during the time when the user assemble or use this product.
2. This product is suitable to be used by people who has operating experience in flying model or age no less than 14 years old.
3. The flying ground we required should be the local field and legal for remote control flying.
4. Once this product is sold , we won't be responsible for any safety responsibility during the time the user operates or uses or controls this product.
5. If there is any problem occurred during the time of using, operating or repairing, please reach our sales agent for details. The sales agent that we authorized will provide you with the technical support and after-sale service.

SAFTY & CAUTIONS

This R/C flying model is a high dangerous commodity. Please make sure that it should be flied far away from the crowd. Please also pay more attention to the phenomenon such as incorrect assembly or damaged model or incorrect connection of electronic control equipment. Please also pay attention to the flying safety when operating and know more about the accident that may be happened due to your own negligence.

1. Keep it far away from the barrier or crowd.
2. Keep it far away from the moisten environment.
3. Use this product correctly and avoid operating by your own.
4. Keep it far away from the high-speed rotating part and heat source.
5. Please conform to the sequence of power ON/OFF. As the picture below shown, incorrect sequence of power ON/OFF may cause this product out of control and affect your own safety or others. Please form a good habit of switching on or switching off this product correctly.

CONTENTS

- Quadcopter
- Transmitter
- Main blades
- Screw 4PCS
- USB Charging Cable
- Screwdriver
- Instruction manual

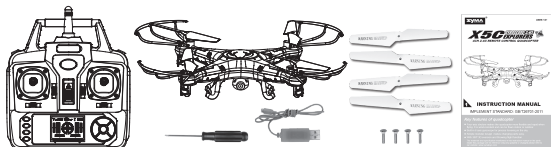

GET TO KNOW YOUR TRANSMITTER

Introduction of transmitter

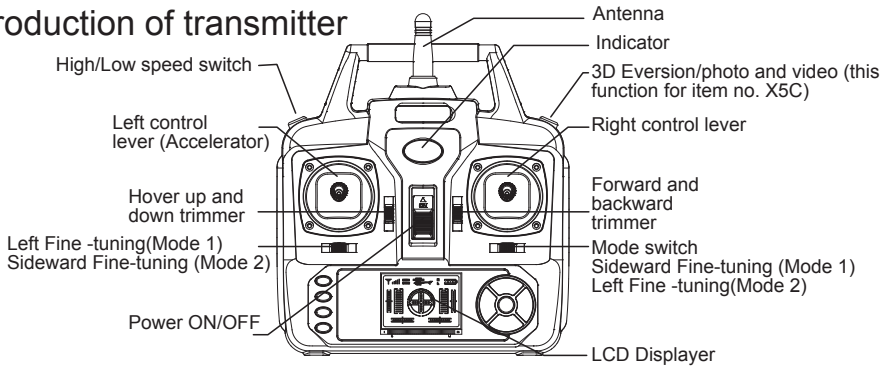

Remote control Installing the battery

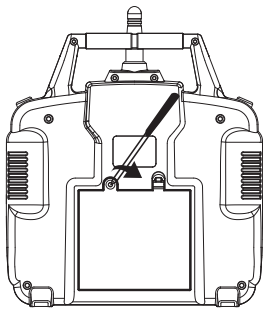

Figure 1

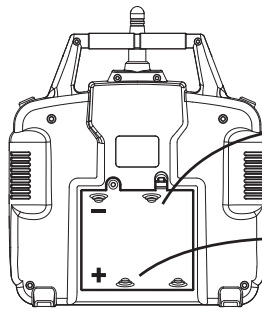
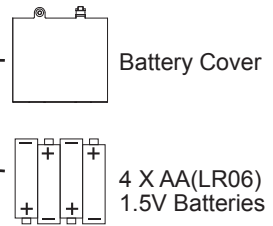

Figure 2



1. Use a screwdriver to remove the screw on the back of transmitter, then open the battery cover (Figure 1).
2. Install 4 "AA" batteries (not included) into the back of transmitter then replace battery cover and reinstall the screw (Figure 2).



1. Install batteries with correct polarity.
2. Do not mix old and new batteries.
3. Do not mix different types of batteries.

REMOTE CONTROL KEYPAD AND LCD MANUAL

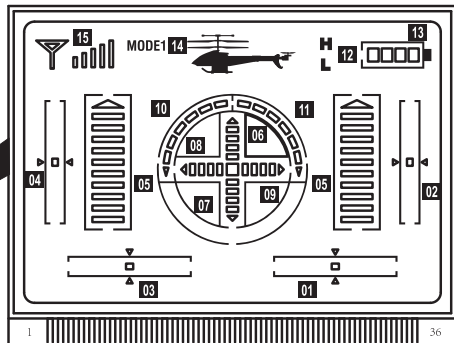
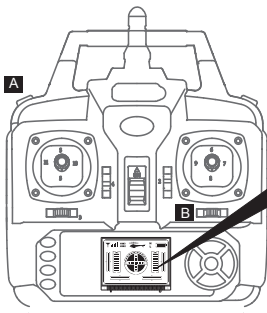

01. Sideward Fine-tuning :Power-on start in the centering.(Be turn Left/Right Fine -tuning in Mode2)
02. Forward/Backward fine-tuning:Power-on start in the middle.
03. Turn Left/Right fine-tuning:Power-on start in centering.(Be Sideward Fly Fine -tuning in Mode2)
04. Throttle lever fine-tuning: Power-on start in middle.
05. Throttle show:Power-on start in lowest level.(Left and Right throttle shows at one time)
06. Forward shows:Power-on start in the lowest level.(At the center square)
07. Backward shows:Power-on start in the lowest level.(At the center square)
08. Right sideward fly shows:Power-on start in the lowest level.(At the center square)
09. Left sideward fly shows:Power-on start in the lowest level.(At the center square)
10. Turn left: Pull left function lever to left, it will be higher, than quad copter turn left faster.
11. Turn right: Pull left function lever to right, it will be higher, than quad copter turn right faster.
12. High/Low speed: Press button "A" for seconds to switch between high speed mode or low speed mode. "H" means high speed and "L" means low speed.
13. Power shows:According to the battery's energy for the controller.
14. Default mode when power-on.When change to MODE 2, please keep pressing button "B" to right than return on the power of transmitter, the MODE on LCD displayer will be changed. Same steps to change to MODE 1 again.
15. Signal shows:Normally to full frame.

READY TO FLY YOUR QUADCOPTER

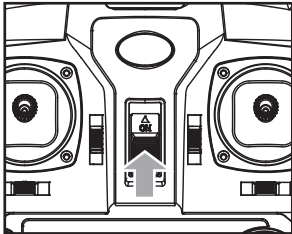

Step 1: Press the ON/OFF power switch up.

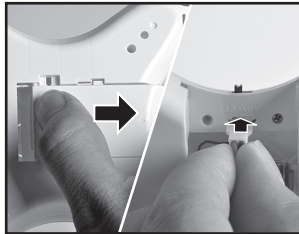

Step2: Open the battery cover and insert the battery into power port.

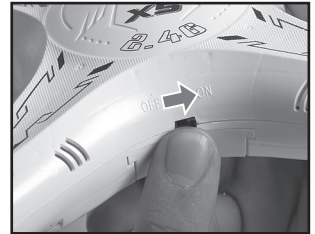

Step 3: Close the battery cover and turn on the quadcopter.

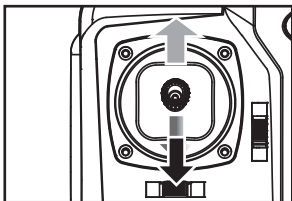

Step 4:Push the throttle lever to the highest position, and then pull it back to the lowest position. There will be one clear sound from the transmitter, this shows that the quadcopter has entered into the pre-fly state.

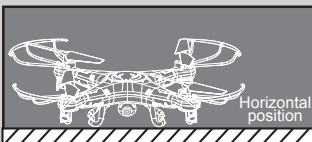

TIPS:When syncing your quadcopter keep it in a horizontal position to start to a stable flight.

CAUTIONS:

1. When the indicator of transmitter keep light on but the indicator of quadcopter is blinking slowly, it means signal matching was not successful. Please turn off the power both of transmitter and quadcopter than restart the transmitter and quadcopter.
2. If the quadcopter is still flying to one side dramatically or spinning while hovering, please switch off the power of both the quadcopter and transmitter and then repeat the pre-flying steps.
3. When the indicator of the quadcopter keeps flashing slowly, it means that the quadcopter has entered into the low battery state. This time you need to charge the quadcopter with the USB cable provided.

CHANGE BATTERY OF QUADCOPTER

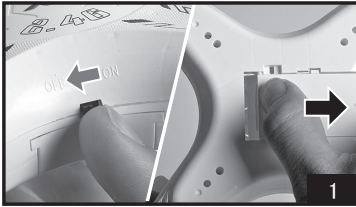

1. Push the on/off switch of quadcopter to OFF position than open the battery cover.

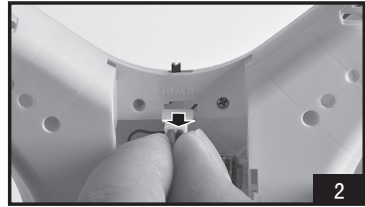

2. Pull out the battery wire from the power port.

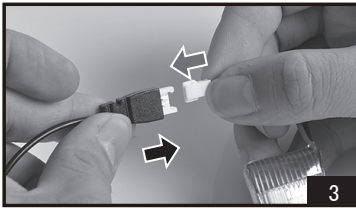

3. Take out the USB charging cable, and insert the battery power port to the small end of it (Make sure the ports connect tight and correct).

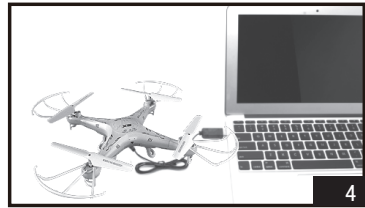

4. To charge battery, please insert the USB port of provided USB charging cable to anyone USB port of computer. The indicator on USB cable will light ON during charging battery, than it will light OFF when battery fully charged.

Caution:

When using the computer for charging, please remember to pull out the charging cable before shutting down the computer. Take the battery cover , and close the battery cover on the quadcopter.

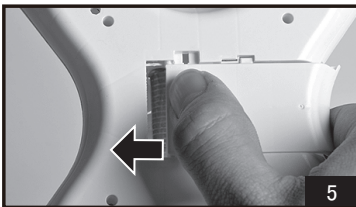

5. Reconnect the battery wire to power port than close the battery cover.

Charging time: about 75 minutes — Flying time: about 7 minutes!

CAUTIONS WHEN CHARGING

1. When charging, please put this product on a dried or ventilated area and keep it far away from heat source or explosive product.
2. When charging, please remove the batteries from the quadcopter. Then charging process should be supervised by an adult so as not to cause an accident.
3. After flying, please do not charge the battery if the surface temperature is still not cool. Otherwise it may cause a swollen battery or even a fire hazard.
4. Please make sure that you use the original USB charging cable provided. When the battery has been used for a long time, or appears to be swollen, please replace them.
5. A battery when not in use for a long time will lose its charge automatically. Charging or discharging too often may reduce the life of the battery.

BATTERY REPAIR & MAINTENANCE

1. Battery should be put in the dried or ventilated place with environment temperature about 18-25°C.
2. In order to enhance the using life of the battery, please avoid repeat charging or excessive discharging.
3. When the battery needs to be stored for a long time, please charge the battery first. That is to say, charge the battery for about 50-60% of the volume and then well store it.
4. If you do not use it for more than 1 months, it's highly recommended that you need to check the battery voltage every month so as to make sure the voltage no less than 3V. Otherwise please do by following No.(3) mentioned.

INSTALL LANDING SKIDS & BLDAE PROTECTING FRAME

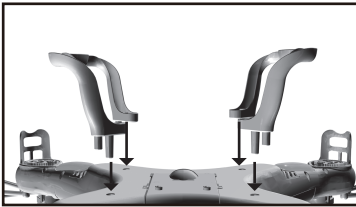

Figure.1

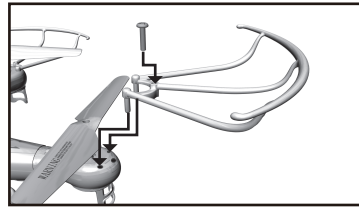
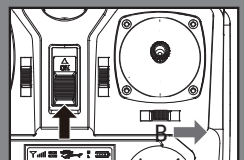

Figure.2

1. Install the landing skids to the bottom of quadcopter (Figure 1).
2. Install the blade protecting frame to every corner than lock screws (Figure 2).

CONTROLLER MODES & INSTRUCTIONS

The transmitter built-in two modes, Mode 1 & Mode 2, in line with different customer's usage pattern. Keep pushing button B to right, than turn on the transmitter power to change Mode 1 or Mode 2.



MODE 1

Operating direction

Hover up and down

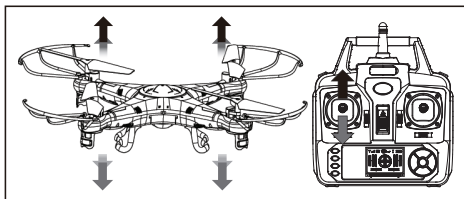

Push the throttle up or down, the quadcopter flies upward or downward.

Forward and backward

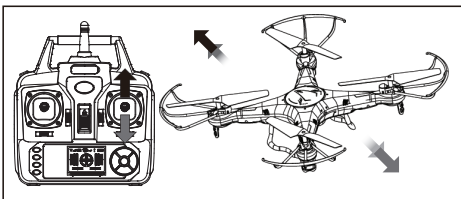

Push the direction lever up or down, the quadcopter flies forward or backward.

Turn Left and Right

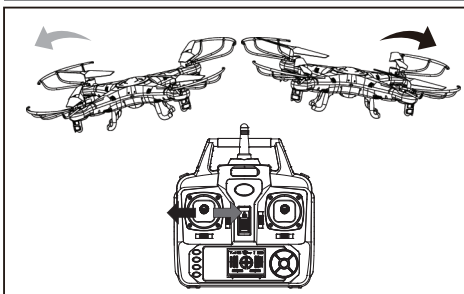

Pull the throttle left or right, the quadcopter turns to left or right.

Sideward fly

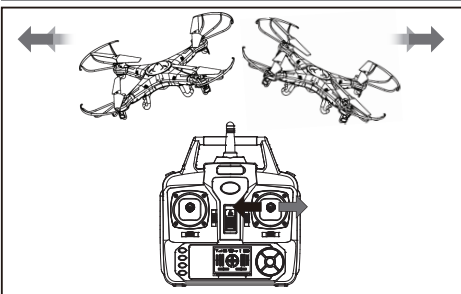

Pull the direction lever left or right, the quadcopter flies to left side or right side.

Fine-tuning operation

Forward/Backward fine-tuning

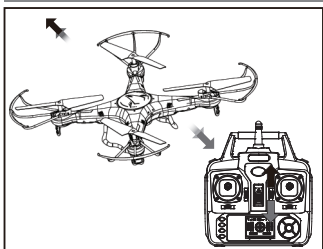

When the quadcopter keeps flying forward / backward, you can correct it by pressing the fine-tuning button down / up.

Sideward fly fine-tuning

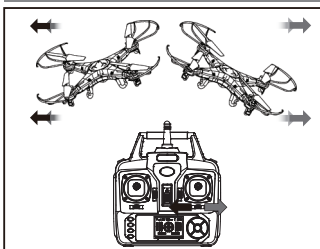

When the quadcopter keeps flying to left / right side, you can correct it by pressing the Fine-tuning button right / left.

Turn left/right fine-tuning

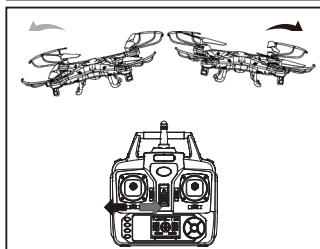

When the quadcopter keeps rotating to left / right, you can correct it by pressing the fine-tuning button right / left.

MODE 2

Operating direction

Hover up and down

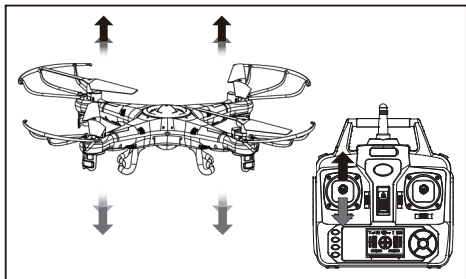

Push the throttle up or down, the quadcopter flies upward or downward.

Forward and backward

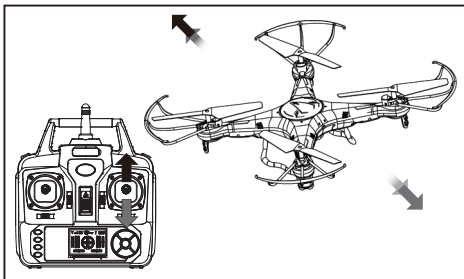

Push the direction lever up or down, the quadcopter flies forward or backward.

Turn Left and Right

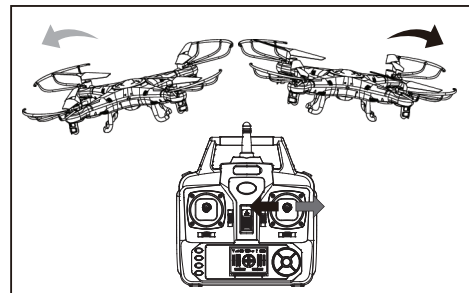

Pull the direction lever left or right, the quadcopter turns to left or right.

Sideward fly

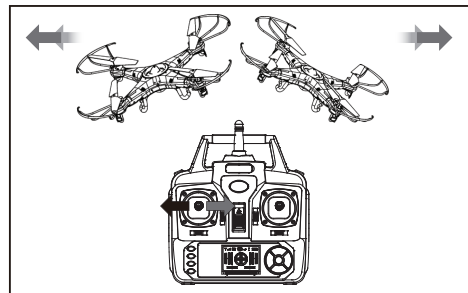

Pull the throttle left or right, the quadcopter flies to left side or right side.

Fine-tuning operation

Forward/Backward fine-tuning

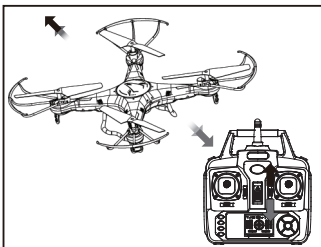

When the quadcopter keeps flying forward / backward, you can correct it by pressing the fine-tuning button down / up.

Sideward fly fine-tuning

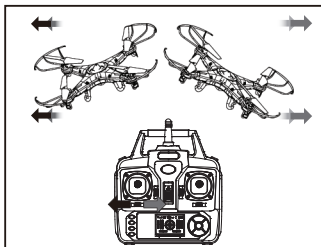

When the quadcopter keeps flying to left / right side, you can correct it by pressing the fine-tuning button right / left.

Turn left/right fine-tuning

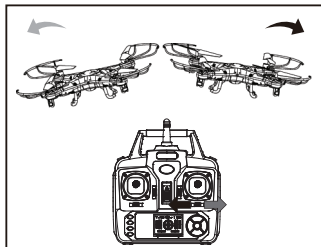

When the quadcopter keeps rotating to left / right, you can correct it by pressing the fine-tuning button right / left.

INTRODUCTION TO QUADCOPTER FUNCTIONS

Low-voltage protection:

When the quadcopter battery is not enough, the rotors will be stopped power supply. As the quadcopter control system will protect battery automatically.

Over-current protection:

When the quadcopter's rotating blade is collided or jammed, the control system will stop supplying power for the rotors automatically. Then please re-match the signal for flying.

Restart function:

In case of flight disorder or sideward flight, restore factory default settings by the following methods:

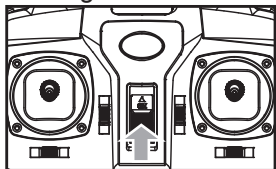

- ①. Press the power switch to turn on the transmitter.

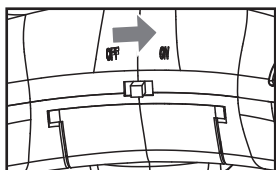

- ②. Press the power switch to turn on the quadcopter.

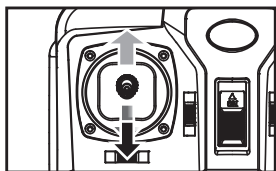

- ③. When the quadcopter indicator quickly flashing to slowly flashing, please push the throttle lever to the highest position, and then pull it back to the lowest position. Then the quadcopter indicator changed from slowly flashing to normal lights up.

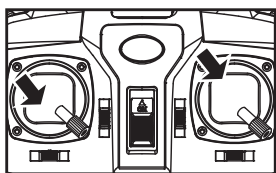

- ④. Place the quadcopter on a horizontal position, then push transmitter both left and right lever to lowest right corner for about 2-3 second, indicator on the quadcopter changed from normal lights up to quickly flashing; After 2-3 second, the indicator changed to normal lights, it means the quadcopter restarted /reset successfully.

3D EVERSION AND THROWING FLIGHT INSTRUCTIONS

When you are familiar with the basic operation, you can do some awesome & exciting tricks and stunts! First of all, fly the aircraft to a height of more than 3 meters, press the 3D Eversion switch on the rear right side of the transmitter, then push the right rudder (in any direction) to make 360 degree flip.

Tips: 3D eversion goes better when battery power is enough.

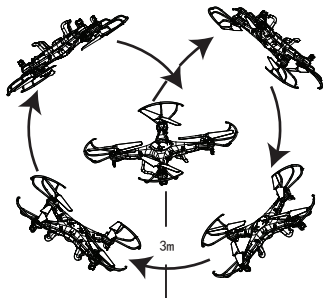

Thanks to the 6 axis gyroscope, you can throw the quadcopter and push the throttle right up, it will automatically level out and hover smoothly in the sky. This can also be done when the quadcopter is rolling.



INSTALL CAMERA

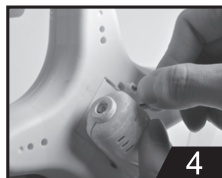
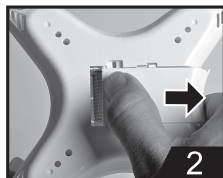
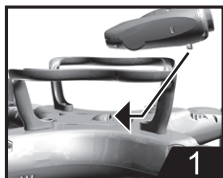

1. Push the camera into a hold on the battery cover (Figure 1).
2. Open the battery cover with camera (Figure 2).
3. Lock screws to add-on the camera tight (Figure 3).
4. Close the battery cover with camera than insert the 3-pin plug to the hold in side (Figure 4).

PHOTOGRAPHY / VIDEO INSTRUCTIONS:

1. Methods:
 - ① Make sure the 3-pin plug of camera is inserted to the quadcopter.
 - ② Turn the quadcopter power on, the camera works normally when the RED indicator change form flashing to green and keep light on. If the RED indicator just light on and light off seconds later, it means the SD card is not in the camera. Please insert the SD card, than the indicator light on GREEN.
2. Get to know take photo and video:
 - ① Turn on the transmitter and pull left lever up and down to connect signal between quadcopter and transmitter.
 - ② Take Photo: Make sure camera normally work, press the button on top right corner one time, camera will take a photo after a beep from transmitter when the GREEN indicator on camera flash one time in RED.
 - ③ Take Video: Make sure camera normally work, press the button on top right corner for seconds, camera start take video when a beep from transmitter and the GREEN indicator on camera change to RED and keep flashing. Press the button slightly again, another beep means video stopped and the RED flashing indicator on camera will keep light on GREEN.



Notes: 3D rollover function of the aircraft is automatically cancelled when camera is installed. Restart aircraft power if there is still 3D rollover function while camera does not work after the camera is installed.

TROUBLE SHOOTING

Problem	Reason	Solution
No response from the quadcopter	1.Quadcopter battery power not enough. 2.Transmitter battery power not enough. 3.The band of the transmitter does not correspond to the decoding of the quadcopter.	1.Charge the quadcopter 2.Charge or replace them if required. 3.Adjust the band on the transmitter and keep it the same as the quadcopter.
If the quadcopter is slow to respond or difficult to manoeuver	1.Insufficient power with the transmitter. 2.Transmitter of the same frequency is used nearby.	1.Replace the battery. 2.Use the helicopter out of the range of other RC quadcopter.

SPARE PARTS

All the spare parts below can be bought from local distributor.

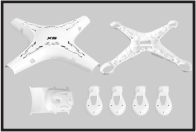

X5C-01
Body cover

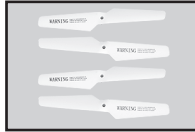

X5C-02
Main blades

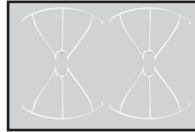

X5C-03
Protecting frames



X5C-04
Landing skids



X5C-05
Motor holder



X5C-06
Lampshades

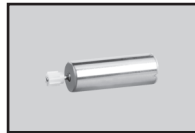

X5C-07
Motor A

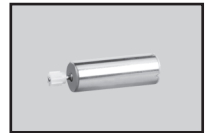

X5C-08
Motor B

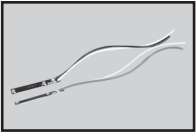

X5C-09
Light boards

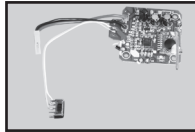

X5C-10
Receiver board

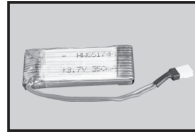

X5C-11
Battery

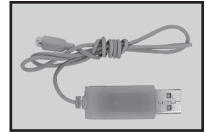

X5C-12
USB charging cable



X5C-13
Camera



X5C-14
Transmitter

BREAKDOWN & DIAGRAM

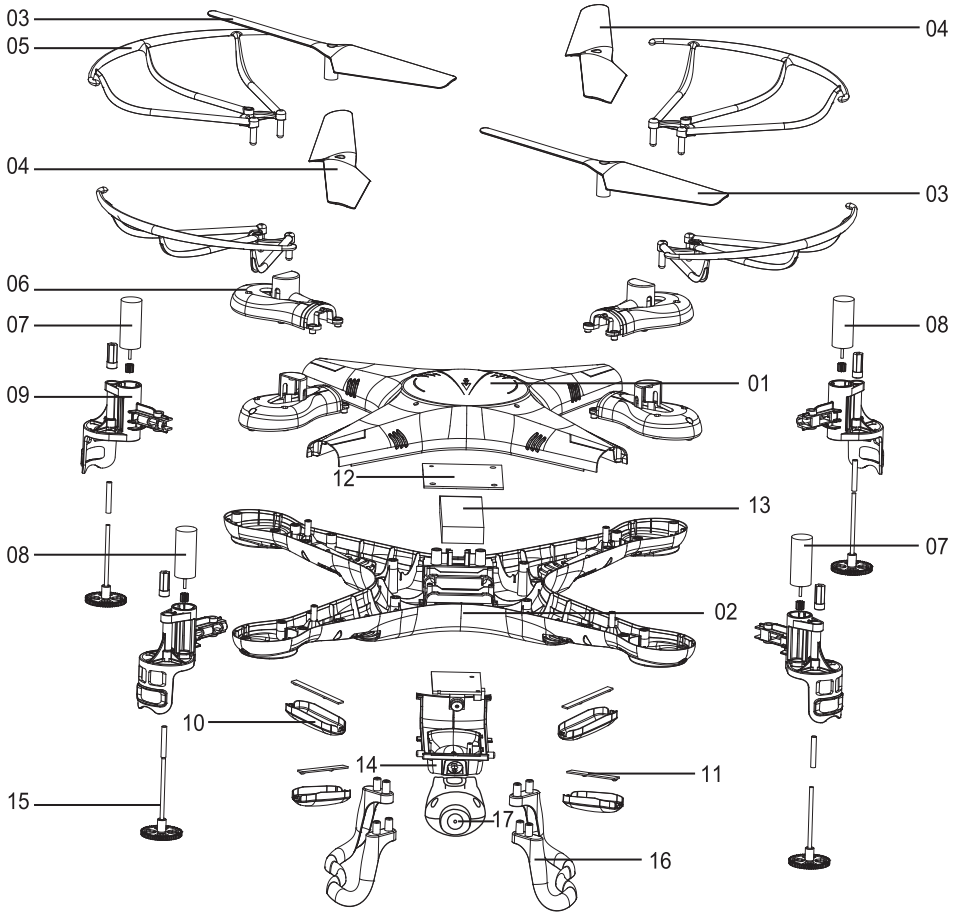

Code	Description	Quantity	Code	Description	Quantity	Code	Description	Quantity
01	Upper body	1	08	Receiver motor	2	15	Gear	4
02	Lower body	1	09	Motor holder	4	16	Landing skids	2
03	Rotating blade	2	10	Lampshades	4	17	Camera	1
04	Reversing blade	2	11	Light boards	4			
05	Protecting frames	4	12	Receiver board	1			
06	Battery cover	4	13	Battery	1			
07	Rotating motor	2	14	Battery cover	1			