

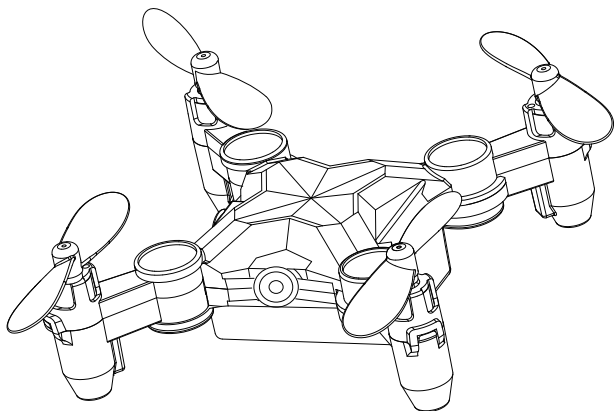

14+
age

INSTRUCTIONS FOR USE



HS190



usa@holystone.com (America)

ca@holystone.com (Canada)

eu@holystone.com (Europe)

jp@holystone.com (Japan)



+1(855) 888-6699

www.holystone.com

CONTENTS

1. Preface	1
2. Safety Guidelines	1
3. Maintenance	3
4. Package Contents	4
5. Specification	5
6. Drone's Details.....	6
7. Assemble the Propeller Guards	6
8. Transmitter Battery Installation	7
9. Charging the Drone Battery	8
10. Flight	
Before Flight	10
Pair the Drone	10
Calibrate the Gyro	11
Unlock the Drone	12
One Key Take- off	12
Flight Control	13
11. Altitude Hold	15
12. Speed Switch	15
13. Emergency Stop	16
14. Flip Mode	16
15. One Key Return	17
16. Headless Mode	18
17. Trouble Shooting	20
18. Contact Us	20
19. General Information	21

< PREFACE >

1. Please read this Disclaimer & Warning and Safety Guidelines carefully before using our product. This product is not recommended for people under the age of 14. By using this product, you hereby agree to this disclaimer and signify that you have read it fully. You agree that you are responsible for your own conduct and any damaged caused while using this product, and its consequences . You agree to use this product only for purposes that are proper and in accordance with local regulations, terms and all applicable polices and guidelines Holy Stone may make available.

2. When using this product, please be sure to strictly abide by the specification requirements and safety guidelines stated in this document. Any personal injury property damage, legal disputes and all other adverse events caused by the violation of the safety instructions or due to any other factor, WILL NOT be Holy Stone's responsibility.

< SAFETY GUIDELINES >

Check Before Use

- ① This product is not a toy, but it is a high precision drone that integrates various electronic stability and control mechanisms. Please be sure to setup this drone carefully and correctly to ensure safe, accident-free operation.
- ② Please be sure that the batteries of the drone and transmitter are clean, undamaged and, fully charged.
- ③ Please be sure that all the propellers are undamaged and are installed in the correct orientation.
- ④ Please do a thorough check of the product before each use. Check for firmness of the parts, any signs of cracks and wear of the propeller, battery power and effectiveness of the indicator, etc. If after doing a complete check any issues are found, please refrain from using the product until the issue has been resolved.

Flight Environment



+



+



Fly in Open Areas

**Maintain Line
of Sight**

**Fly Below
197 feet (60 m)**



Avoid flying over or near obstacles, crowds, high voltage power lines, trees, airport or bodies of water.

DO NOT fly near strong electromagnetic sources such as power lines and base stations as it may affect the onboard compass.



DO NOT use the drone in adverse weather conditions such as rain, snow, fog and strong wind.

Operations Requirements

- ① Please don't use this product to follow any moving vehicles .
- ② During the flight, only turn off the motor in case of an emergency.
- ③ Please flight the drone back to you as soon as possible when the battery is running low.
- ④ This product should not be used while drinking alcohol, if you are feeling fatigued, taking medicine, or feeling any physical discomfort.
- ⑤ Beware of the noise volume the drone produces. Keep your distance to avoid ear damage.



Stay away from the rotating propellers and motors.





No Fly Zone

Use of Battery

- ① Please ensure batteries are fitted in the correct orientation as shown in the instruction manual.
- ② Avoid short circuits by fitting the batteries incorrectly, and do not crush or squeeze the batteries as this could carry the risk of an explosion.
- ③ Do not mix new and old batteries as this can lead to a poor performance of the product.
- ④ Dispose used batteries carefully, do not litter.
- ⑤ Please keep dead batteries away from heat and fire.







- ⑥ If the device is not going to be used for an extended period of time, remove batteries to prevent potential damage from battery leakage.
- ⑦ If the device is not going to be used for an extended period of time, remove batteries to prevent potential damage from battery leakage.
- ⑧ It is recommended to only use the USB charging cable that comes with the drone to charge the battery.
- ⑨ Don't connect the battery directly to wall outlets or car cigarette-lighter sockets.
- ⑩ Don't attempt to disassemble or modify the battery in any way.
- ⑪ Don't use the battery if it gives off an odor, generates heat, becomes discolored or deformed, or appears abnormal in any way. If the battery is in use or being charged, remove it from the device or charger immediately and discontinue use.
- ⑫ Don't pierce the battery casing with a nail or other sharp object, break it open with a hammer, or step on it!
- ⑬ Always charge the batteries in a fireproof container and away from combustible materials. Don't charge on surfaces that can catch fire. This includes: wood, cloth, carpet, or in the application's device.
- ⑭ Don't immerse the battery in water or allow it to get wet.
- ⑮ Don't solder battery terminal directly.
- ⑯ Keep battery out of reach of children or pets.
- ⑰ Don't short-circuit the battery by connecting wires or other metal object to the positive(+) and negative(-) terminals.

	Li-Po Battery Disposal & Recycling	
<p>Waste Lithium-polymer batteries must not be placed with household trash. Please contact local environmental or waste agency or the waste agency or the supplier of your model or your nearest Li-Po battery recycling center.</p>		

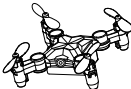
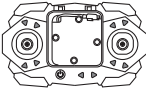
<MAINTENANCE>

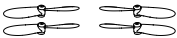
1. Clear the product after each use with a clean, soft cloth.
2. Avoid prolonged exposure to direct sunlight and avoid buildup of heat on the drone.
3. This device is not waterproof and must not be submerged in water under any circumstance. Failure to maintain the device completely dry will result in the failure of the unit.
4. Check the charging plug and other accessories for signs of damage frequently. If any part of the device is damaged, refrain from flying until maintenance can be carried out.

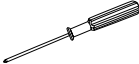
< PACKAGE CONTENTS >

No.	Part Name	Picture	Quantity
1	Drone		1
2	2.4G Transmitter		1
3	Propeller Guards		4
4	Additional Propellers		4
5	USB Charging Cable		1
6	Screwdriver		1
7	Propeller Spanner		1
8	Instructions For Use		1

DRONE

Model: HS190

Weight: 23.3g / 0.82oz

Flight Time: 5~7 minutes

Motor Model: 615

Operating Temperature Range: 32° to 104°F (0° to 40°C)

Dimensions: 62 x 62 x 24mm

Transmitter

Operating Frequency: 2.4GHz

Max transmission distance: 50m

(Outdoor And Unobstructed)

Battery: 1.5V AAA Li-Po Battery

Operating Temperature: 32° to 104° F (0° to 40° C)

FLIGHT BATTERY

Capacity: 220 mAh

Voltage: 3.7 V

Battery Type: LiPo

Energy: 0.814Wh

Charging Temperature Range: 41° to 104°F (5° to 40°C)

Charging Time: 30~40 mins

(Depending on Charging Power)

< DRONE'S DETAILS >

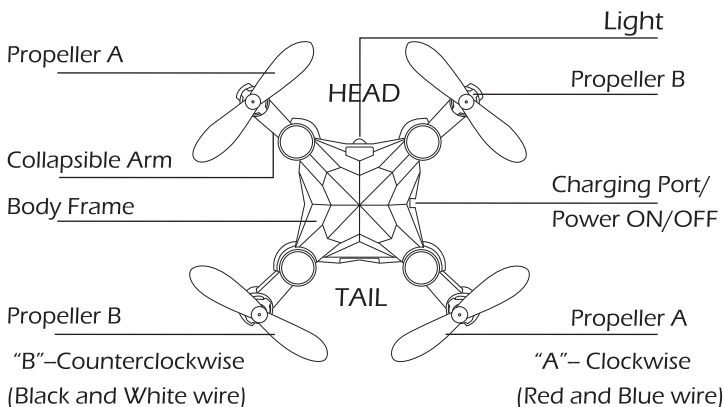

! Please note that all propellers must be installed in the correct orientation. (Pay attention to the letter “A” or “B” printed on each propeller when installing.)

< ASSEMBLE THE PROPELLER GUARDS >

Since the speed of this drone is very fast, we suggest the pilot install the propeller guards before flying. Please install the propeller guards according to the diagrams below.

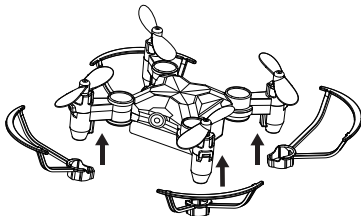

Install the propeller guards to motor base.

< TRANSMITTER FUNCTIONS >

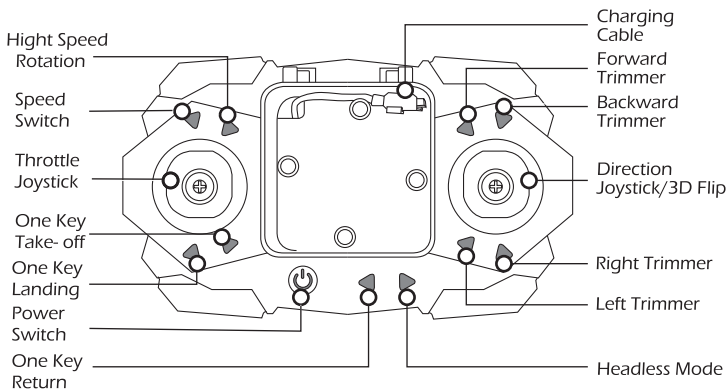

< TRANSMITTER BATTERY INSTALLATION >

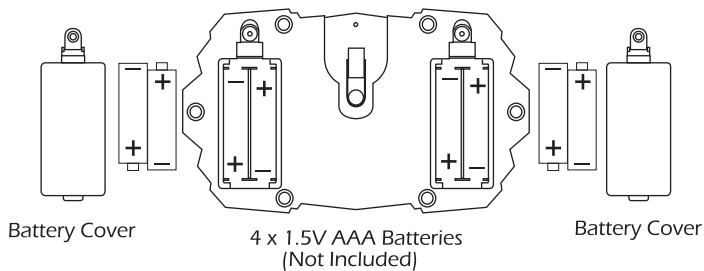

Note: Always pay close attention to battery polarity when inserting any batteries to make sure they are fitted correctly.

< CHARGING THE DRONE BATTERY >

There are two ways to charge the drone battery(3.7V 220mAh).

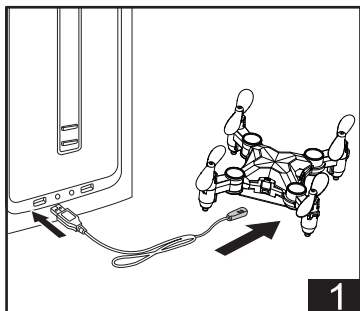

- ① Turn off the drone, and insert the USB charging cable into a computer USB port or a USB adapter (5V/0.5 = 1.0 A).
- ② Connect the drone to USB charging cable, the red indicator light on the charging cable will turn on, indicating that the battery is under charging.
- ③ The indicator light will go off when the drone battery is fully charged.

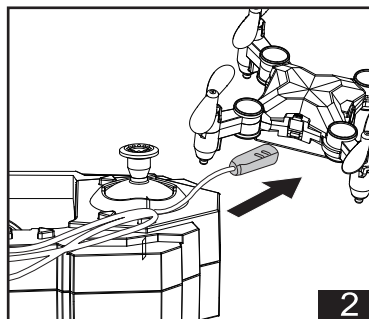

- ① Turn off the drone, and turn on the transmitter.
- ② Connect the drone to USB charging cable which is built in the transmitter.
- ③ The power switch light will turn blue, indicating that the battery is in charging.
- ④ The light will turn red when the drone battery is fully charged.

< CHARGING THE DRONE BATTERY >

Note:

The charging time is around 30~40 minutes.

Flying time is about 5~7 minutes.

When the drone's battery is in low power, the LED indicator lights on the drone will be blinking.

Please make sure the batteries of transmitter are full of power before charging the drone if you choose the second way to charge the drone).

CAUTIONS

- 1) Don't use or charge the battery if it shows signs of swelling, punctures, or damage in any way.
- 2) Don't charge the battery directly after use. Allow it to cool down in an open and dry area to insure overheating does not occur.
- 3) When battery is charged, please keep it away from furniture, carpet or anything flammable.
- 4) Don't charge the battery overload(below 5V/2A). Make sure the battery is removed from the charger when charging is complete. Never overcharge the battery.
- 5) Be cautious while removing a battery from the charger. And it's possible to strip the cords and lead to a fire(and ruin the battery)

< FLIGHT >

- ⚠ • Rotating propellers can be dangerous. Do not start the motors when there are people nearby.
- Always keep your hands on the transmitter so long as the motor is still spinning.

Before Flight

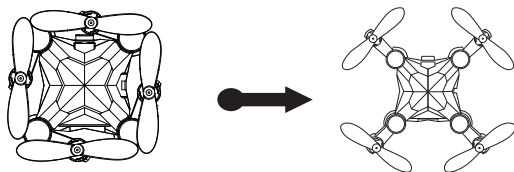

① Please unfold the collapsible arms before flight.

Pair the Drone:

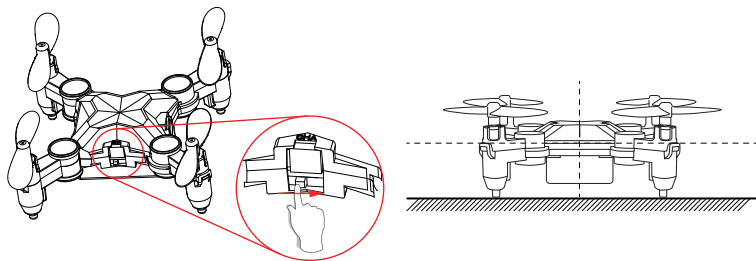

② First, slide the “Power Switch” button right to turn on the drone. Then, place the drone on flat and level surface with the head facing forward and the tail facing towards the pilot.

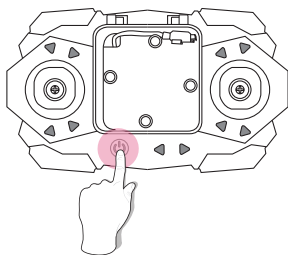

③ Then, turn on the Transmitter. One second later, one beep will be heard and the drone's indicator lights will start flashing and then turn solid, indicating that the drone and the transmitter have been paired successfully and automatically.

Calibrate the Gyro

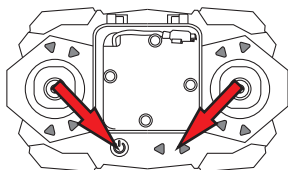

④ After pairing, push the left joystick down to the bottom right and the right joystick down to the bottom left at the same time. A beep sound will be heard from the transmitter and the LED lights of the drone will blink, then turn solid, indicating that the calibration setting is completed.

(To ensure a stable flight, we suggest the pilot calibrate the gyro every time after pairing the drone and after a crash. And please do NOT calibrate the gyro while flying.)

Unlocking the drone

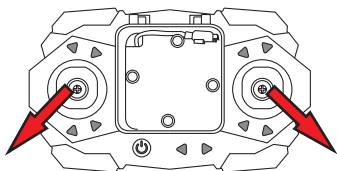

⑤ After pairing or calibration, pull left joystick down to the bottom left, the right joystick down to the bottom right at the same time. The LED indicator lights on the drone will blinking and turn sold again, and the propellers will start spinning, indicating that the drone is unlocked and ready to take off.

One Key Take-off

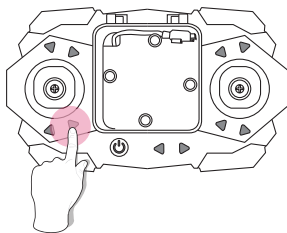

⑥ Press One Key Take-off button, the drone will take off automatically. Or push throttle(left) joystick up slowly to take off and ascend the drone .

Flight Control

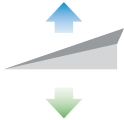

⑦ Left (Throttle) Joystick.

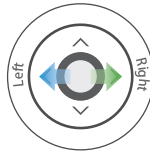
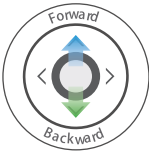

⑧ Right (Direction) Joystick.

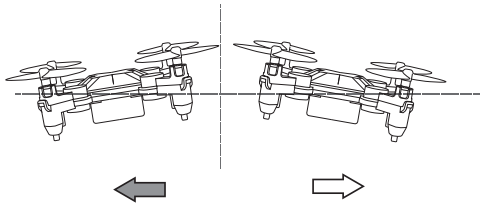
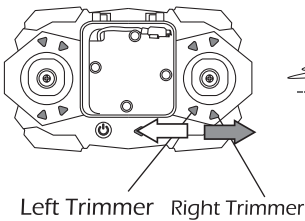

⑨ **Left/ Right Sideward Fly Trim:** When the drone drifts to left, press the right trimmer button to rebalance the drone; if the drone drifts to right, press the left trimmer button to rebalance the drone.

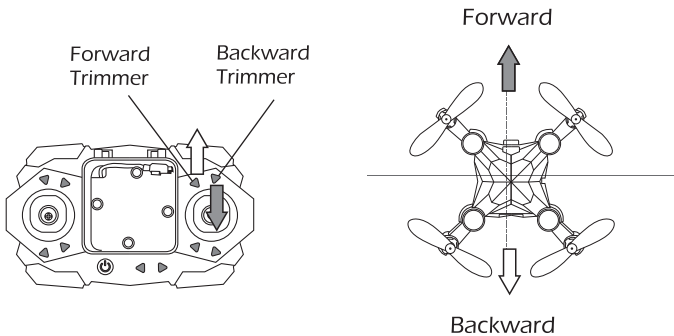

⑩ **Forward/ Backward Sideward Fly Trim:** When the drone drifts forward, press the backward trimmer button to rebalance the drone; if the drone drifts backward, press the forward trimmer button to rebalance the drone.

NOTE:

When the drone loses balance, calibration and the trim buttons don't work, we suggest the pilot try to reset the drone's trimmer data.

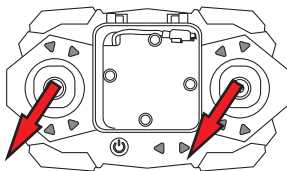

Pull both joysticks down to the bottom left at the same time, then the drone's lights will blink and turn solid, indicating the drone's trimmer data is reset (This step can only be done before the drone take off).

< ALTITUDE HOLD >

This drone is equipped with Altitude Hold function, meaning this drone will keep in a steady altitude.

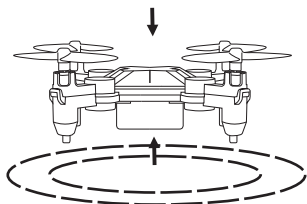

During flight, altitude hold function allows you to release the throttle joystick, and the drone will keep hovering at the current height.

< SPEED SWITCH >

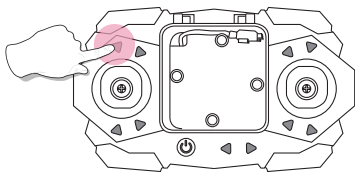

This drone comes with 3 speed modes(Low/ Medium/ High). Press the “Speed Switch” button on transmitter to switch the speed mode. “Di” from the transmitter indicates it is in low speed mode, “DiDi” indicate medium speed, and “DiDiDi” indicate high speed. **(Low speed will be default mode!)**

<EMERGENCY STOP>

- !** Only stop motors mid-flight in emergency situations when doing so can reduce the risk of damage or injury.

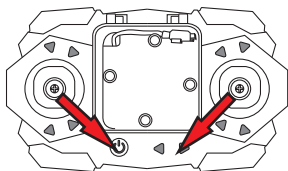

Emergency Stop

While flying, push the Left Joystick down to the bottom right and the right joystick down to the bottom left at the same time for about one second to enter EMERGENCY STOP function, and the motors will stop immediately.

< FLIP MODE>

When you become familiar with all the functions of the drone, you can try this amazing flip mode. Make sure you fly the drone at least 10 feet, press the direction(right) joystick to enter Flip Mode, then push the Right Joystick to the Forward/ Backward/ Left/ Right, and the drone will do a flip towards the corresponding direction.

Caution: The drone will flip best when the battery is fully charged.

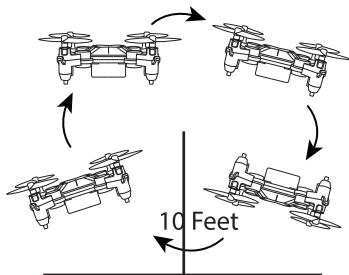

< ONE KEY RETURN >

! Please avoid using this feature when the drone is near to the pilot, otherwise it may cause injury.

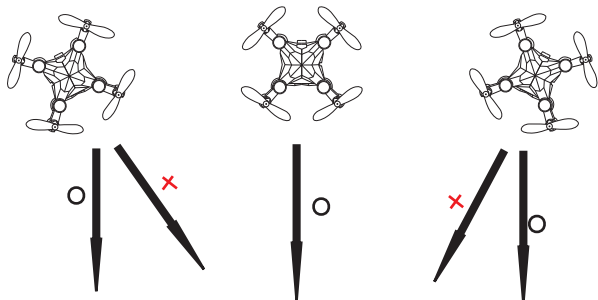

X Wrong Track

O Right Track

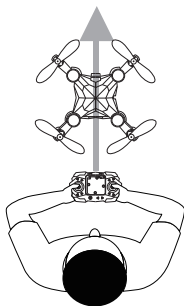

With a press of the One Key Return button, the drone will return along the parallel direction where the tail of the drone pointed to when the drone was paired.

You can push the right joystick forward or press the One Key Return button again to retake control of the drone and cancel the One Key Return Function.

< HEADLESS MODE >

! Do not use the Headless Mode until you totally comprehend the Instructions For Use. Flying in Headless Mode without sufficient experience might result in loss or damage of the device.

1. Place the drone in front of the pilot before pairing the drone to the transmitter. Make sure the head of the drone faces forward and the tail faces towards the pilot.

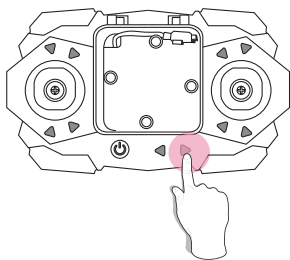

2. After pairing and calibration, press the Headless Mode button to enter Headless Mode function. Three beeps will be heard from the transmitter, and the drone's lights will start blink constantly.

3. Press the Headless Mode button again, (the drone's light will turn to solid) the drone will exit Headless Mode.

< HEADLESS MODE >

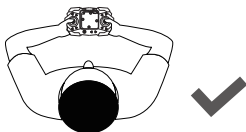
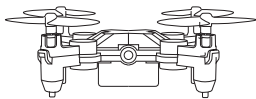

The direction of control when the drone is paired

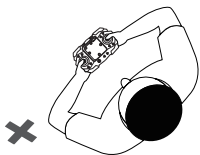

Don't turn your direction

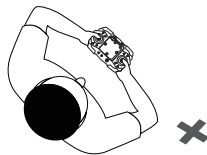

Don't turn your direction

Under Headless Mode, the forward direction is the direction the pilot faces when the pilot pairs the drone with the transmitter. If the pilot pushes the direction joystick forward, the drone will fly forward. If the pilot pushes the direction joystick backward, the drone will fly towards him/her. If the pilot moves the direction joystick left or right, the drone will also move left or right relative to him/her. It is very important that the pilot does not change positions or the direction he or she faces; otherwise the drone will get confused.

! Please use Headless Mode and One Key Return function after you totally comprehend these functions; otherwise, it may cause some loss and damage.

Trouble Shooting

THE PROBLEMS	REASONS	SOLUTIONS
The indicator lights of the drone are flashing and do not respond to the transmitter.	<ol style="list-style-type: none"> 1. The transmitter is not synced to the drone. 2. Insufficient battery power. 	<ol style="list-style-type: none"> 1. Refer to the preparation for FLIGHT and pair again. 2. Recharge the battery.
The propellers spin, but the drone cannot take off.	<ol style="list-style-type: none"> 1. Insufficient battery power. 2. The propellers are installed in wrong orientation. 3. The propellers are distorted. 	<ol style="list-style-type: none"> 1. Recharge the battery. 2. Install the propellers in right orientation. 3. Replace the propellers.
The drone sways sharply.	The propellers are distorted.	Replace the propellers.
Drone cannot stay balanced in flight.	<ol style="list-style-type: none"> 1. The propellers are distorted. 2. The motor doesn't work properly. 	<ol style="list-style-type: none"> 1. Replace the propellers. 2. Replace the motor.
The drone is out of control after crashing.	Six-axis acceleration sensor loses its balance after crashing.	Restart and re-calibrate the drone.

For more further technical support, please do not hesitate to contact us via Email or Hot Line Phone Call.



usa@holystone.com (America)
ca@holystone.com (Canada)
eu@holystone.com (Europe)
jp@holystone.com (Japan)



+1(855) 888-6699

General Information

FCC Information

This device complies with Part 15 of the FCC Rules. Operation is subject to the following two conditions:

- (1) This device may not cause harmful interference.
- (2) This device must accept any interference received, including interference that may cause undesired operation.

NOTE: This equipment has been tested and found to comply with the limits for a Class B digital device, pursuant to Part 15 of the FCC Rules. These limits are designed to provide reasonable protection against harmful interference in a residential installation. This equipment generates uses and can radiate radio frequency energy and, if not installed and used in accordance with the instructions, may cause harmful interference to radio communications. However, there is no guarantee that interference will not occur in a particular installation. If this equipment does cause harmful interference to radio or television reception, which can be determined by turning the equipment off and on, the user is encouraged to try to correct the interference by one or more of the following measures:

- Reorient or relocate the receiving antenna.
- Increase the separation between the equipment and receiver.
- Connect the equipment into an outlet on a circuit different from that to which the receiver is connected.
- Consult the dealer or an experienced radio/TV technician for help.

WARNING: Changes or modifications not expressly approved by the party responsible for compliance could void the user's authority to operate the equipment.

RF Exposure

The equipment complies with FCC radiation exposure limits set forth for an uncontrolled environment. This device should be installed and operated with minimum distance 20cm between the radiator & your body.

IC Notice:

This device complies with Canada Industry licence-exempt RSS standard(s). Operation is subject to the following two conditions:

- (1) this device may not cause interference; and
- (2) this device must accept any interference. Including interference that may cause undesired operation of the device.

CAN ICES-3 (B)

Avis d'Industrie Canada

Le présent appareil est conforme aux CNR d'industrie Canada applicables aux appareils radio exempts de licence L'exploitation est autorisée aux deux conditions suivantes:

- 1) l'appareil ne doit pas produire de brouillage; et
- 2) l'utilisateur de l'appareil doit accepter brouillage radioélectrique subi même si le brouillage est susceptible d'en compromettre le fonctionnement. mauvais fonctionnement de l'appareil.

Cet appareil numérique de la classe B est conforme à la norme NMB-003 du Canada.

CAN NMB-3 (B)

RF Exposure

Radiation Exposure Statement:

This equipment complies with IC radiation exposure limits set forth for an uncontrolled environment.

This equipment should be installed and operated with minimum distance 20cm between the radiator & your body.

Déclaration d'exposition aux radiations:

Cet équipement est conforme aux limites d'exposition aux rayonnements IC établies pour un environnement non contrôlé.

Cet équipement doit être installé et utilisé avec un minimum de 20 cm de distance entre la source de rayonnement et votre corps.

HOW TO RECYCLE THIS PRODUCT

This symbol on the product or its documentation indicates that it must not be disposed of with household waste. Uncontrolled waste disposal may harm the environment or human health.

Please separate your device from other types of waste to recycle it responsibly. This will help to foster the sustainable re-use of material resources.

We invite you to contact your retailer or inquire at your local town hall to find out where and how the drone can be recycled.



BATTERY WAENING:

- 1.Failure to follow all the instructions may result in serious injury, irreparable damage to the battery and may cause a fire, smoke or explosion.
- 2.Always check the battery's condition before charging or using it.
- 3.Replace the battery if it has been dropped, or in case of odour, overheating, discolouration, deformation or leakage.
- 4.Never use anything other than the approval LiPo charger the battery. Always use a balancing charger for LiPo cells or a LiPo cell balancer. It is recommended that you do not to use any other charger than the one provided with the product.
- 5.The battery temperature must never exceed 60°C(140°F) otherwise the battery could be damaged or ignite.
- 6.Never charger on a flammable surface, near flammable products or inside a vehicle (preferably place the battery in a non-flammable and on-conductive container).
- 7.Never leave the battery unattended during the charging process. Never disassemble or modify the housing's wiring, or puncture the cells. Always ensure that the charger output voltage corresponds to the voltage of the battery. Do not short circuit the batteries.
8. Never expose the LiPo battery to moisture or direct sunlight, or store it in a place where temperatures could exceed 60°C(car in the sun, for example).
- 9.Always keep it out of reach of children.
- 10.Improper battery use may result in a fire, explosion or other hazard.
- 11.Non-rechargeable batteries are not to be recharged. Rechargeable batteries are only to be charged under adult supervision.

12. Different types of batteries or new and used batteries are not to be mixed.
13. Batteries are to be inserted with the correct polarity.
14. The supply terminals are not to be short-circuited. Regular examination of transformer or battery charger for any damage to their cord, plug, enclosure and other parts and they must not be used until the damage has been repaired.
15. The packaging has to be kept since it contains important information.
16. The toy is only to be connected to Class II equipment bearing the symbol. 

EU RRF Power(EIRP):-7.71dBm (2413MHz ~ 2461MHz)

Caution

1. The max operating of the EUT is 45°C. and shouldn't be lower than -10°C.
2. The device complies with RF specifications when the device used at 0mm from your body.
3. Declaration of Conformity

We, Xiamen Huoshiquan Import & Export CO., LTD

hereby, declare that the essential requirements compliance with the Directive 2014/53/EU, the RoHS Directive 2011/65/EU and Safety Directive 2009/48/EC have been fully fulfilled on our product with indication below:

Product Name: REMOTE CONTROL MODEL/RADIO CONTROLLED HELICOPTER

Model/Trademark : HS190/HOLY STONE

The Statement of compliance is available at the following address:
http://www.holystone.com/Download/CE/HS190_EU_DOC.pdf

This product can be used across EU member states.

MANUFACTURER INFORMATION

Manufactured by Xiamen Huoshiquan Import & Export CO., LTD
Room 703, No. 813-2 Xiahe Road, Siming District, XIAMEN, China
+1(855) 888-6699



Made in China