

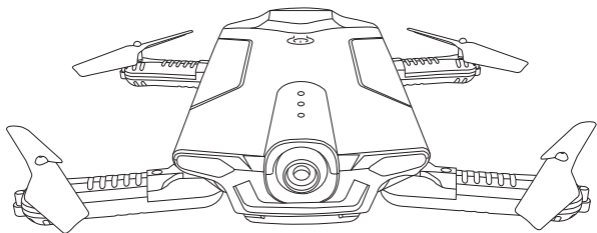



14+  
age

# INSTRUCTIONS FOR USE

2.4GHz FPV real-time video and image transmitter drone



## HS160

 [usa@holystone.com](mailto:usa@holystone.com) (America)  +1(855) 888-6699  
[ca@holystone.com](mailto:ca@holystone.com) (Canada)  
[eu@holystone.com](mailto:eu@holystone.com) (Europe)  
[jp@holystone.com](mailto:jp@holystone.com) (Japan)

# CONTENTS

1. Preface .....	1
2. Warnings .....	2
3. Maintenance .....	4
4. Package Contents .....	5
5. Specification .....	6
6. Transmitter Functions .....	8
7. Drone's Details.....	9
8. Transmitter Battery Installation .....	9
10. Drone Parts Installation .....	10
11. Charge and Install the Drone Battery .....	11
12. Fly Safe Informations .....	13
13. Flight .....	14
Pair the Drone .....	15
Start the Drone .....	16
Flight Control .....	17
14. Emergency Stop .....	19
15. Calibrate the Gyro .....	19
16. Altitude Hold .....	20
17. Headless Mode .....	21
18. Wi-Fi Camera Function .....	23
APP Installation .....	23
Wi-Fi Connection .....	24
Take Photo/Record Video.....	24
19. Trouble Shooting .....	25
20. General Information .....	26

## < PREFACE >

To make your experience with this drone as straightforward and convenient as possible, please read this instructions before operating and keep it for the future reference and maintenance.

### **Important Statement:**

1. This product is not a toy, but it is a high precision drone that integrates various electronic stability and control mechanisms. This drone requires careful and correct assembly and setup to ensure safe, accident-free operation. This equipment should be operated in a safe and controlled manner at all times. Incorrect or hazardous operation may cause damage to the device or property, or cause serious injury to those in the vicinity.
2. This product is suitable for experienced drone pilots over 14 years of age.
3. In case of having difficulties on any aspect of the product, operation or maintenance, please contact your local sales agent or contact customer support here at Holy Stone.

### **Safety Guidelines**

This product is flying camera that offers easy, controllable flight when in good working order, however, there is also a significant risk to property and people if flown irresponsibly or within confined spaces. Incorrect assembly or poor control by inexperienced pilots can result in damage to property or harm to people in an accident. Be fully aware of your surroundings when flying and always maintain complete control of the vehicle at all times.

#### **1. Keep in Distance:**

- a. Always fly in locations that are clear of any obstructions, such as buildings, poles, electrical wires, trees and so on.
- b. Never fly above or near people and spectators.

#### **2. Do not fly in adverse weather conditions:**

- a. Keep clear of moisture, fog, ice and excessive wind.
- b. Fly in good weather conditions only.

#### **3. Use and maintain the product according to the instructions for use:**

- a. Operate this device legally in accordance with instructions provided and with local laws and regulations.
- b. Always use original parts manufactured by Holy Stone for maintenance and repair.

#### **4. Do not operate the device alone.**

- a. If you are a new pilot, seek assistance from an experienced drone pilot when learning.
- b. Have others around to help you fly at all times.

## **5. Safety First every time:**

a. Always operate the drone within your ability as a pilot. If you are ill, disoriented, or unsure of how to effectively fly the drone, please seek help to avoid danger, damage or injury.

## **6. Keep clear of rotation parts:**

a. During operation the rotors revolve extremely quickly, please avoid touching the blades and ensure that foreign objects are kept clear of all moving parts.

## **7. Avoid exposure to excessive heat:**

a. Due to the numerous material types used in construction, this drone is not suitable for exposure to heat. Please keep your device away from heat sources and avoid prolonged exposure to direct sunlight. High temperatures is capable of distorting the structure of drone and lead to unpredictable consequences.

# **<WARNINGS>**

1. The information and guidance within this package and instructions for use are important for the safe operation and maintenance of your drone. Please keep it well for future reference.

2. You accept sole responsibility for any injury, loss or damage that result from your operation of the device.

3. Always follow the instructions when assembling or operating the drone. Always keep at least 2 meters between the user or viewers and the model to avoid risk of injury. Pay attention to the device at all times while flying.

4. Neither Holy Stone nor any distributors or agents accepts any responsibility for loss, injury or damage caused by incorrect operation of the drone.

5. This drone is not suitable for children under the age of 14. Younger pilots should always operate the drone under the supervision of an adult.

6. Please ensure assembly instructions are followed correctly to ensure proper operation and performance of your drone.

7. This product contains small parts. To avoid any choking hazard, please keep this drone and all its components out of the reach of children.

8. You must not, under any circumstance, fly this drone over open water or near any public road to avoid risk of accident.

9. Keep all packaging materials away from children and dispose them in a safe manner.

10. The internals of the drone are not user serviceable, please do not attempt to disassemble this drone or replace any part of the drone, to avoid malfunctions during flight.











11. Please ensure batteries are fitted in the correct orientation as shown in these instructions.

12. You can access the transmitter battery compartment by unscrewing the screws on the battery cover. Insert batteries ensuring they are in the right orientation. Always put battery cover back and tighten the screw to secure before use.
13. Only use the charger provided with your drone for safety.
14. The charger is not a toy.
15. Always pay close attention to battery polarity when inserting any batteries to make sure they are fitted correctly.
16. Use either rechargeable or nonrechargeable "AA" batteries in the transmitter. Do not mix battery types.
17. Use only recommended batteries in the transmitter, please remember that non-rechargeable batteries must not be charged.
18. For rechargeable batteries, always follow manual instructions for use and have adult supervision. Do not leave charging batteries unsupervised and as batteries get hot when charging, avoid any combustible material.
19. Avoid short circuits by fitting the batteries incorrectly, and do not crush or squash batteries as this carries a risk of explosion.
20. Do not mix new and old batteries as this can lead to unpredictable performance.
21. Dispose used batteries carefully, do not litter.
22. The power socket must not be removed from this drone. Do not attempt to short circuit the connection socket.
23. When disposing batteries, do not throw on fires, leave to decomposer. Keep clear of heat sources and high temperatures at all time.
24. If the device is not going to be used for an extended period, remove batteries to prevent potential damage from battery leakage.
25. Care should be taken to keep your drone away from sources of magnetic interference of other electrical equipment to prevent signal issues during operation.
26. Keep clear of rotating parts and beware of loose clothing that could become entangled in the rotors causing injury.
27. Beware of the noise volume the drone produces. Keep your distance to avoid ear damage.
28. The charger socket uses a mini USB 5V connection.
29. Always use the product in compliance with local aviation radio rules and comply with local authorities who require you to refrain from operating at any time.

## <MAINTENANCE>

1. Clear the product after each use with a clean, soft cloth.
2. Avoid prolonged exposure to direct sunlight and avoid buildup of heat on the drone.
3. This device is not waterproof and must not be submerged in water under any circumstance. Failure to maintain the device completely dry will result in the failure of the unit.
4. Check the charging plug and other accessories for signs of damage frequently. If any part of the device is damaged, refrain from flying until maintenance can be carried out.

# Package Contents

No.	Part Name	Picture	Quantity
1	Drone		1
2	2.4G Transmitter		1
3	3.7V 500mAh Li-Po Battery		2
4	Additional Propellers		4
5	USB Charging Cable		1
6	Screwdriver		1
7	Instructions For Use		1
8	Dustproof Bag		1
9	Joysticks		4
10	Phone Holder		1

## <SPECIFICATION>

### Drone

Model: HS160

Weight: 63.8g

Flight Time: 6~8 minutes

WIFI Distance: 30 m (Outdoor And Unobstructed)

Motor Model: 701855

Hovering: Enabled

Operating Temperature Range: 32° to 104°F (0° to 40°C)

### CAMERA

Still Photography Modes : Single Shot

Video Recording Modes: HD1280x720p

Max Video Bitrate: 25 Mbps

Photo: JPEG

Video: AVI

Operating Temperature Range: 32° to 104°F (0° to 40°C)

### APP / LIVE VIEW

Mobile App: HS-D2

Live View Working Frequency: 2.4 GHz ISM

Live View Quality: 720P @ 20fps

Latency: Low Latency Video (depend on conditions and mobile device)

Required Operating Systems: iOS 9.0 or above / Android 4.0 or above

Recommended Devices: 4.7" to 6.0" Smart phones



## <SPECIFICATION>

### TRANSMITTER

Operating Frequency: 2.4 GHz

Max Transmission Distance: 50 m (outdoors and unobstructed)

Operating Temperature Range: 32° to 104°F (0° to 40°C)

Battery: 4×1.5 V Alkaline batteries AA

Mobile Device Holder: Smart phones

### FLIGHT BATTERY

Capacity: 500 mAh

Voltage: 3.7 V

Battery Type: LiPo

Energy: 1.85 Wh

Net Weight: 18.6 g

Charging Temperature Range: 41° to 104°F (5° to 40°C)

Charging Time: 50~70 mins

### USB CHARGING CABLE

Voltage: 5 V

Rated Power: ≤10 W

## <TRANSMITTER FUNCTIONS>

### Mode 2(Recommend!)

Left hand throttle Mode 2 will be default setting.

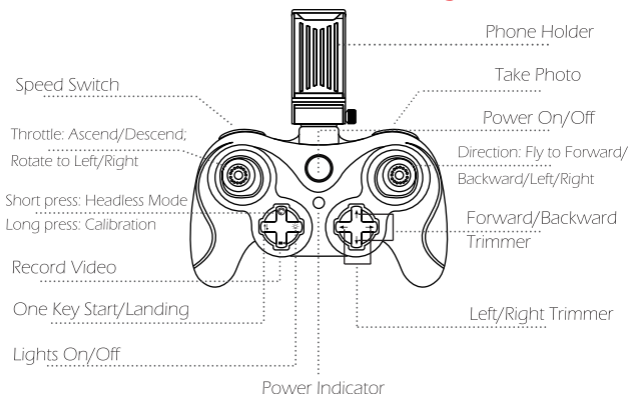

### Mode 1

Turn on the transmitter while holding the up left(Speed Switch) button to enter Mode 1.(Please don't release the up left button until the transmitter is powered on.)

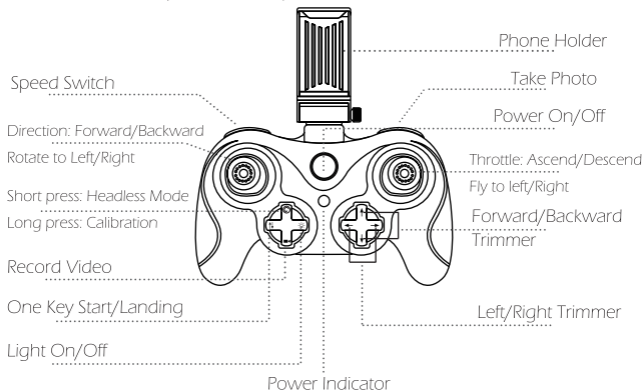

## <DRONE'S DETAILS>

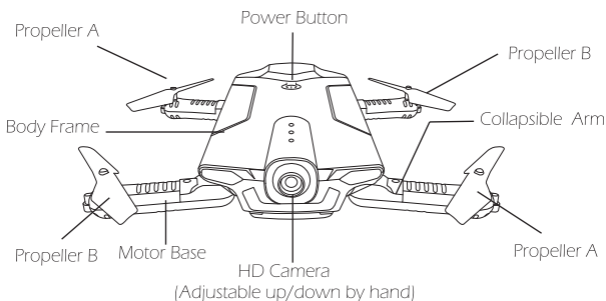

**!** Please note that all propellers must be installed in the correct orientation. (Pay attention to the letter "A" or "B" printed on each propeller when installing.)

## < TRANSMITTER BATTERY INSTALLATION >

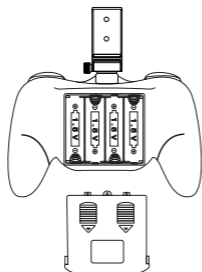

Battery Cover



4 x AA Batteries  
(Not Included)

## <DRONE PARTS INSTALLATION>

### Install the Joysticks

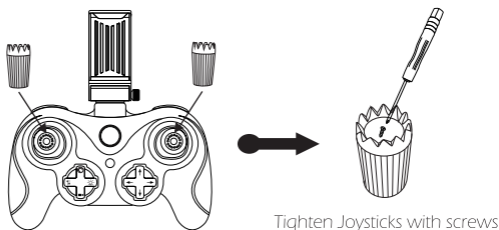

Install two joysticks into the bracket slot on the transmitter, and tighten them with screws.

### Install the Phone Holder



This model uses Wi-Fi and HD camera to display real-time images on smartphones. To do this, you need to install the phone holder to catch your smartphone, so that you can see the real-time images on your phone when you use transmitter to control the drone.

## < CHARGE AND INSTALL THE DRONE BATTERY >

1. Balanced charging: Connect the USB charging cable to a computer or a USB adapter (5V/0.5-1.0A recommended). The red indicator lights turn on when the USB charging cable is connected to the power supply. The red indicator light turns off when the battery is charging. The red indicator light turns on again when the battery is fully charged.
2. Charging time: about 50~70 Minutes
3. When the drone is in low power, the LED lights blink slowly. Please land your drone and charge the battery.

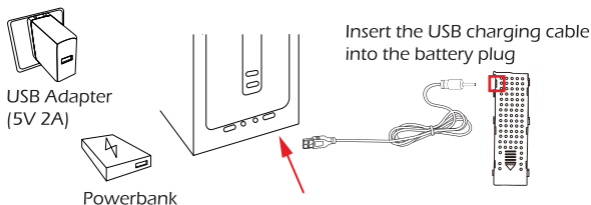

## Install the Battery

1. Place the battery on the battery compartment, then, push the battery forward to install the battery.

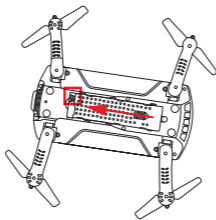

2. Press the battery lock, and push the battery backward at the same time to take battery out.

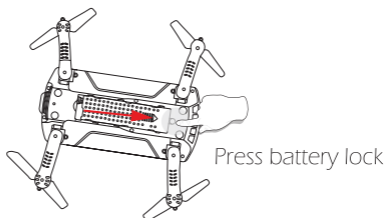

### CAUTIONS

- 1) Don't use or charge the battery if it shows signs of swelling, punctures, or damage in any way.
- 2) Don't charge the battery directly after use. Allow it to cool down in an open and dry area to insure overheating does not occur.
- 3) When battery is charged, please keep it away from furniture, carpet or anything flammable.
- 4) Don't charge the battery overload (below 5V/2A). Make sure the battery is removed from the charger when charging is complete. Never overcharge the battery.
- 5) Be cautious while removing a battery from the charger. And it's possible to strip the cords that leads to a fire (and ruin the battery)



#### Li-Po Battery Disposal & Recycling

Wasted Lithium-Polymer batteries must not be placed with household trash. Please contact local environmental or waste agency or the supplier of your model or your nearest Li-Po battery recycling center.



## Fly Safe Information



+



+



Fly in Open Areas

Maintain Line  
of Sight

Fly Below  
150 feet (50 m)



Avoid flying over or near obstacles, crowds, high voltage power lines, trees, airport or bodies of water.

DO NOT fly near strong electromagnetic sources such as power lines and base stations as it may affect the onboard compass.



DO NOT use the drone in adverse weather conditions such as rain, snow, fog and windy.

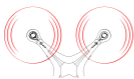

No Fly Zone

Stay away from the rotating propellers and motors.



It's important to understand basic flight guidelines, for the safety of those around you. Don't forget to read the Safety and Guidelines before flight.

## <FLIGHT>

- ! Rotating propellers can be dangerous. Do not start the motors when there are people nearby.
- Always keep your hands on the transmitter so long as the motor is still spinning.
- Only stop motors mid-flight in emergency situations when doing so can reduce the risk of damage or injury. Refer to the instructions.

**Please Note, all of the following operations are taking Mode 2 for example.**

### Before You Begin

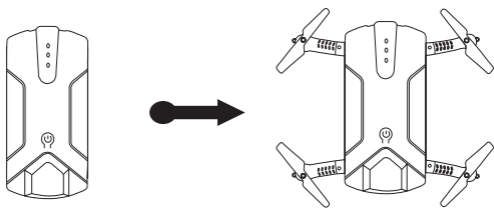

Please unfold the collapsible arms before flight.



## Pair the Drone

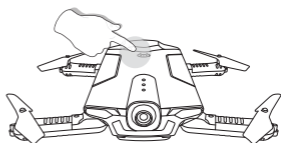
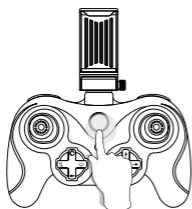

- ① Power on the transmitter and the drone, the LED indicator lights on the drone will be blinking.

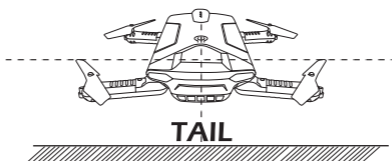

- ② Place the drone on flat and level surface with the head faces forward and the tail faces towards the pilot.

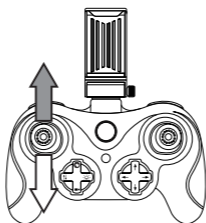

- ③ Push left joystick up then down to pair the drone and the transmitter. The LED indicator lights on the drone will be solid if the drone is paired successfully.

## Start the Drone

- ④ After pairing the drone, there are three ways to start the drone:



(The first way)

- a. Press the One Key Start/Lading button to start the drone.

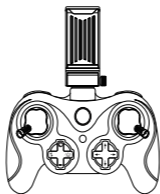

(The second way)

- b. Push the left joystick to the bottom left; push right joystick to the bottom right at the same time to start the drone.



(The third way)

- c. Push left joystick to the bottom right; push right joystick to the bottom left at the same time to start the drone. The propellers will start spinning, indicating the drone is ready to take off.

## Flight Control

### ⑤ Throttle (Left) Joystick



### ⑥ Direction (Right) Joystick

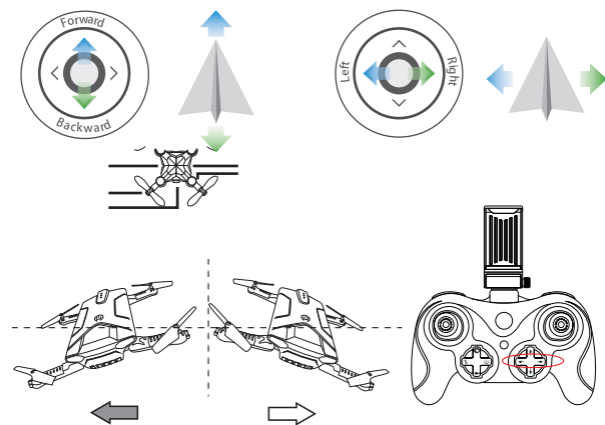

- ⑦ **L/R Sideward Fly Trim** : When the drone drifts left or right, press Left/Right Trimmer button to re-balance the drone. (Press Left on the right Directional Pad if it drifts right; press Right on the right Directional Pad if it drifts left).

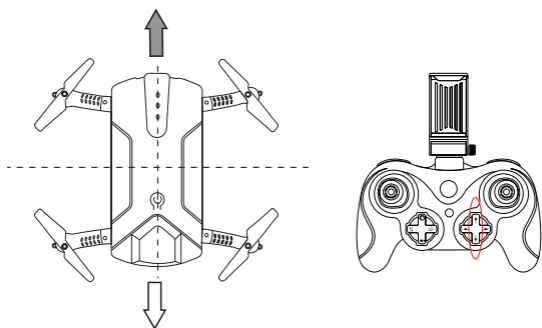

- ⑧ **F/B Sideward Fly Trim** : When the drone drifts forward or backward, press Forward/Backward Trimmer button to re-balance the drone. (Press Up on the right Directional Pad if it drifts backward; press Down on the right Directional Pad if it drifts forward).

## <EMERGENCY STOP>

-  Only stop motors mid-flight in emergency situations when doing so can reduce the risk of damage or injury.



### Emergency Stop

Press the UP LEFT and the UP RIGHT button on the transmitter at the same time to enter EMERGENCY STOP function, and the motors will stop immediately.

## <CALIBRATE THE GYRO>

When drone loses balance after cracks and the trim buttons don't work, we suggest operator to recalibrate the Gyro.

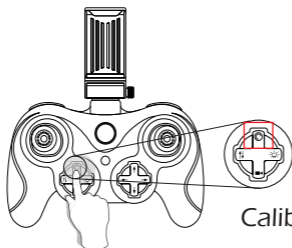

### Calibrate the Gyro

Place the drone on flat and level surface, and long press the calibration button until the LED lights on the drone start blinking and turn solid. Indicating the gyro is setting completed.

## <ALTITUDE HOLD>

This drone is equipped with Altitude Hold function, means this drone will keep in a steady altitude.

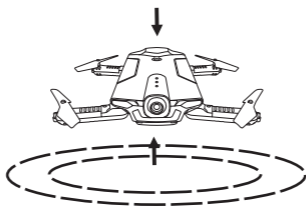

During flight, altitude hold function allows you to release the throttle joystick, and the drone will keep hovering at the current height.

- ⚠ Reliable communication range between the drone and the transmitter is around 50 meters depending on terrain and conditions. Wi-Fi signal is about 30 meters. The range was measured under an open field under breezeless condition, without Wi-Fi signal or radio signal interference. If your drone loses signal at any point, you will lose control of the model and it will automatically land by itself.

## <HEADLESS MODE>

- !** Do not use the Headless Mode until you totally comprehend the Instructions For Use. Flying in Headless Mode without sufficient experience might result in loss or damage of the device.

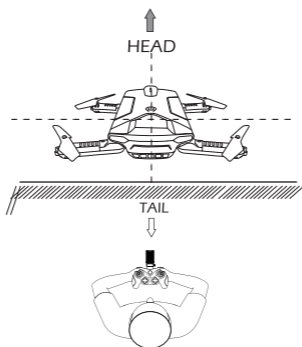

1. Place the drone on flat and level surface with the head faces forward and the tail faces towards the pilot.

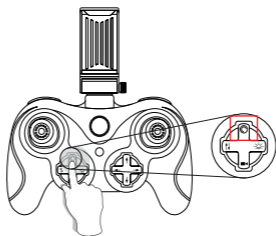

2. Push the left joystick up then down to pair the transmitter to the drone.
3. Short press the Headless Mode button on the transmitter, you will hear one beep and the indicator lights on the drone and the transmitter will start blink, which means the drone is under Headless Mode.

## <HEADLESS MODE>

4. Press the Headless Mode button again, you will hear two beeps from the transmitter, and the indicator lights on the drone and the transmitter will turn solid, which means the drone is exits Headless Mode.

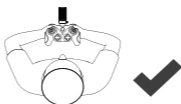

The direction of control when pair the drone.



Don't turn your direction



Don't turn your direction

Under Headless Mode, the forward direction is the direction the pilot faces when the pilot pairs the drone with the transmitter. If the pilot pushes the direction joystick forward, the drone will fly away from you. If the pilot pushes the direction joystick backward, the drone will flight towards him/her. If you move the right stick left or right, then the drone will also move left or right relative to you. It is very important that the pilot does not change positions or the direction he or she is facing, because this will cause confusion on the drone.



## APP Installation

This drone is equipped with FPV real-time camera function as well as gravity sensor control function. Please download the “HS-D2”App to use these functions.



Registered trademarks

APP Store is a trademark of Apple Inc.

Google Play is a trademark of Google Inc.

Wi-Fi is a registered trademark of Wi-Fi Alliance.

All other trademarks mentioned in this guide are protected and are the property of their respective owners.

### Applicable Mobile Phones:

Apple/Sumsung/Motorola/LG/HTC etc.

The above mobile phones are for reference only. APP for this drone is not only compatible with the above phones.



### Applicable System:

iOS 9 and above/Android 4.0 or above.

### Wi-Fi Connection

1. Power on your drone, then go into your phone settings, select Wi-Fi, then connect to “HolyStoneFPV\*\*\*” signal.
2. Input the Wi-Fi password: 6264657134
3. Once the drone is successfully connected, exit the settings menu on your phone, and open the “HS-D2” App to see real-time images.

### Take Photo/Record Video

1. Take Photo: Click “**Photo**” icon on the APP interface; or you can press the photo button on the upper right transmitter to take photo.
2. Record Video: Click “**Record Video**” icon on the APP interface; or you can press the “” button on the transmitter to record video. Click “**Record Video**” icon or press “” button again to stop recording and save video. All the images and videos are saved in the phone and APP.

**(Please don't take pictures while recording.)**

## < TROUBLE SHOOTING >

THE PROBLEM	REASON	SOLUTION
The indicator lights of the drone are flashing and does not respond to the transmitter.	1. Communication between the drone and transmitter is bad. 2. Battery power is low.	1. Refer to the preparation for FLIGHT and pair again. 2. Recharge the battery.
The propellers spin but the drone is unable to take off.	1. The propellers are assembled in wrong orientation. 2. The propellers are distorted.	1. Install the propellers in right orientation. 2. Replace the propellers.
The drone shakes badly.	The propellers are distorted.	Replace the propellers.
The trimmer button fails to keep the drone balanced.	1. The propellers are distorted. 2. The motor doesn't work properly.	1. Replace the propellers. 2. Replace the motor.
The drone is out of control after crashing.	Gyro sensor loses its balance after crashes.	Put the drone on a level surface and recalibrate the gyro.

Please do not hesitate to contact us if you need further support.



usa@holystone.com (USA)  
ca@holystone.com (CA)

eu@holystone.com (EU)  
jp@holystone.com (JP)



+1(855) 888-6699

## GENERAL INFORMATION

FCC Notice:

This device complies with Part 15 of the FCC Rules.

Operation is subject to the following two conditions:

- (1) This device may not cause harmful interference.
- (2) This device must accept any interference received, including interference that may cause undesired operation.

NOTE: This equipment has been tested and found to comply with the limits for a Class B digital device, pursuant to Part 15 of the FCC Rules. These limits are designed to provide reasonable protection against harmful interference in a residential installation. This equipment generates and can radiate radio frequency energy and, if not installed and used in accordance with the instructions, may cause harmful interference to radio communications. However, there is no guarantee that interference will not occur in a particular installation. If this equipment does cause harmful interference to radio or television reception, which can be determined by turning the equipment off and on, the user is encouraged to try to correct the interference by one or more of the following measures:

- Reorient or relocate the receiving antenna.
- Increase the separation between the equipment and receiver.
- Connect the equipment into an outlet on a circuit different from that to which the receiver is connected.
- Consult the dealer or an experienced radio/TV technician for help.

WARNING: Changes or modifications not expressly approved by the party responsible for compliance could void the user's authority to operate the equipment.

## RF Exposure

The equipment complies with FCC radiation exposure limits set forth for an uncontrolled environment. This device should be installed and operated with minimum distance 20cm between the radiator & your body.

## IC Notice:

This device complies with Canada Industry licence-exempt RSS standard(s).

Operation is subject to the following two conditions:

- (1) this device may not cause interference; and
- (2) this device must accept any interference. Including interference that may cause undesired operation of the device.

## CAN ICES-3 (B)

### Avis d'Industrie Canada

Le présent appareil est conforme aux CNR d'industrie Canada applicables aux appareils radio exempts de licence. L'exploitation est autorisée aux deux conditions suivantes:

- 1) l'appareil ne doit pas produire de brouillage; et
- 2) l'utilisateur de l'appareil doit accepter le brouillage radioélectrique subi même si le brouillage est susceptible d'empêcher le fonctionnement normal de l'appareil. Cet appareil numérique de la classe B est conforme à la norme NMB-003 du Canada.

## CAN NMB-3 (B)

### RF Exposure

#### Radiation Exposure Statement:

This equipment complies with IC radiation exposure limits set forth for an uncontrolled environment. This equipment should be installed and operated with minimum distance 20cm between the radiator & your body.

Déclaration d'exposition aux radiations:

Cet équipement est conforme aux limites d'exposition aux rayonnements IC établies pour un environnement non contrôlé. Cet équipement doit être installé et utilisé avec un minimum de 20 cm de distance entre la source de rayonnement et votre corps.

#### HOW TO RECYCLE THIS PRODUCT

This symbol on the product or its documentation indicates that it must not be disposed of with household waste.

Uncontrolled waste disposal may harm the environment or human health.

Please separate your device from other types of waste to recycle it responsibly. This will help to foster the sustainable re-use of material resources.

We invite you to contact your retailer or inquire at your local town hall to find out where and how the drone can be recycled.



#### BATTERY WARNING:

- 1.Failure to follow all the instructions may result in serious injury, irreparable damage to the battery and may cause a fire, smoke or explosion.
- 2.Always check the battery's condition before charging or using it.
- 3.Replace the battery if it has been dropped, or in case of odour, overheating, discolouration, deformation or leakage.
- 4.Never use anything other than the approval LiPo charger the battery. Always use a balancing charger for LiPo cells or a LiPo cell balancer. It is recommended that you do not to use any other charger than the one provided with the product.
- 5.The battery temperature must never exceed 60°C (140°F) otherwise the battery could be damaged or ignite.

6. Never charge on a flammable surface, near flammable products or inside a vehicle (preferably place the battery in a non-flammable and non-conductive container).
7. Never leave the battery unattended during the charging process. Never disassemble or modify the housing's wiring, or puncture the cells. Always ensure that the charger output voltage corresponds to the voltage of the battery. Do not short circuit the batteries.
8. Never expose the LiPo battery to moisture or direct sunlight, or store it in a place where temperatures could exceed 60°C (car in the sun, for example).
9. Always keep it out of reach of children.
10. Improper battery use may result in a fire, explosion or other hazard.
11. Non-rechargeable batteries are not to be recharged. Rechargeable batteries are only to be charged under adult supervision.
12. Different types of batteries or new and used batteries are not to be mixed.
13. Batteries are to be inserted with the correct polarity.
14. The supply terminals are not to be short-circuited. Regular examination of transformer or battery charger for any damage to their cord, plug, enclosure and other parts and they must not be used until the damage has been repaired.
15. The packaging has to be kept since it contains important information.
16. The toy is only to be connected to Class II equipment bearing the symbol. 

## Caution

- 1.Risk of explosion if battery is replaced by an incorrect type.  
Dispose of used batteries according to the instructions.
- 2.The max operating of the EUT is 45°C. and shouldn't be lower than -10°C.
- 3.The device complies with RF specifications when the device used at 0mm form your body.
- 4.Declaration of Conformity

EU RF Power(EIRP):-22.75dBm(2404MHz ~ 2480MHz)

We, Xiamen Huoshiquan Import & Export CO., LTD hereby, declare that the essential requirements compliance with the Directive 2014/53/EU, the RoHS Directive 2011/65/EU and Safety Directive 2009/48/EC have been fully fulfilled on our product with indication below:

Product Name: Remote control four axis series

Model /Trademark: HS160/HOLY STONE

The Statement of compliance is available at the following address:

[http://www.holystone.com/Download/CE/HS160\\_EU\\_DOC.pdf](http://www.holystone.com/Download/CE/HS160_EU_DOC.pdf)

This product can be used across EU member states.

## MANUFACTURER INFORMATION

Manufactured by

Xiamen Huoshiquan Import & Export CO., LTD

Room 703,No. 813-2 Xiahe Road, Siming District, XIAMEN, China

+1(855) 888 -6699



**Made in China**