

## FCC Part 15 C Notice

CAUTION: Changes or modifications not expressly approved by the party responsible for compliance could void the user's authority to operate the equipment.

NOTE: This equipment has been tested and found to comply with the limits for a Class B digital device, pursuant to Part 15 of the FCC Rules. These limits are designed to provide reasonable protection against harmful interference in a residential installation. This equipment generates, uses and can radiate radio frequency energy and, if not installed and used in accordance with the instructions, may cause harmful interference to radio communications. However, there is no guarantee that interference will not occur in a particular installation. If this equipment does cause harmful interference to radio or television reception, which can be determined by turning the equipment off and on, the user is encouraged to try to correct the interference by one or more of the following measures:

- Reorient or relocate the receiving antenna.
- Increase the separation between the equipment and receiver.
- Connect the equipment into an outlet on a circuit different from that to which the receiver is connected.
- Consult the dealer or experienced radio/TV technician for help.

This device complies with Part 15 of the FCC Rules. Operation is subject to the following two conditions :

- (1) This device may not cause harmful interference, and
- (2) this device must accept any interference received, including interference that may cause undesired operation.

This equipment complies with FCC/ IC radiation exposure limits set forth for an uncontrolled environment. This equipment should be installed and operated with minimum distance 20cm between the radiator and your body.

Cet équipement est conforme aux limites d'exposition aux radiations FCC/IC établies pour un environnement non contrôlé. Cet équipement doit être installé et utilisé avec une distance minimale de 20 cm entre le radiateur et votre corps.

This Regulation require it to be separately collected so that it can be treated using the best available recovery and recycling techniques. This will minimize the impact on the environment and human health from soil and water contamination by any hazardous substances, decrease the resources required to make new products and avoid using up landfill space.

Batteries or battery packs must be recycled or disposed of properly. When this product has reached the end of its useful life it should not be disposed of with other household waste.

You can return an old product to your retailer when you buy a similar new one. For other options, please contact your local council.

Please do your part by keeping this product out of the municipal waste stream!

The "wheelie bin" symbol means that the battery should be collected and not be disposed of with other household waste.

The toy is only to be connected to Class II equipment bearing the symbol.



### WEEE Directive & Product Disposal

At the end of its serviceable life, this product should not be treated as household or general waste. It should be handed over to the applicable collection point for the recycling of electrical and electronics equipment, or returned to the supplier for disposal.

### Internal/Supplied Batteries

This symbol on the battery indicates that the battery is to be collected separately. This battery is designed for separate collection at an appropriate collection point.



Costco France  
1 avenue de Bréhat  
91140 Villebon-sur-Yvette, France  
01 80 45 01 10  
www.costco.fr

Conforms to safety requirements of RED 2014/53/EU and FCC.

Voyage Aeronautics™ is the registered trademark of Amax Group USA, LLC.  
AMAX Group USA Address: 12645 Memorial Dr Suite F1 #388 Houston, TX 77024

© 2020 All Rights Reserved. visit us at [www.amaxbrands.com](http://www.amaxbrands.com)

Made in China  
CT-6164  
C0085-FRN-V 1.0

# PA-1008

## PALM SIZED HIGH PERFORMANCE DRONE



## INSTRUCTION BOOKLET

**WARNING:** Never leave product charging unattended for extended periods of time. Always disconnect PA-1008 from charger immediately after the PA-1008 is fully charged. Please refer to enclosed safety instructions.

### PACKAGE CONTAINS:

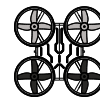

PA-1008



2.4G Wireless Controller



USB Charging Cord



Spare Parts



Instruction Booklet

Colors and styles may vary slightly.

## TABLE OF CONTENTS

Features.....	2
Remote Control Battery Installation.....	2
Charging the PA-1008.....	2
PA-1008 Diagram, Remote Diagram.....	3
Preparing for Flight.....	4
Syncing Your PA-1008.....	4
Flying Tips.....	4
Now You Are Ready To Fly!.....	5
Recognizing the Front and Rear of the PA-1008.....	5
Automatically Take Off / Land.....	5
Understanding The Altitude Lock.....	5
Speed Setting Button.....	5
T (Training) Mode.....	5
Understanding Trim Adjustments.....	6
Forward / Backward Trim.....	6
Banking Left / Right Trim.....	6
3/4 Channel Select.....	7
4 Channel Flight Control.....	7
3 Channel Flight Control.....	8
Calibrating the PA-1008.....	9
How To Do 360° Stunt Rolls.....	9
PA-1008 Warning:.....	10
Battery Warnings, Care and Maintenance.....	10
Replacing the Propeller Blade.....	10
Limited 90-Day Warranty.....	11
FCC Part 15 C Notice.....	14

Thank you for purchasing the 2.4 G Indoor /Outdoor PA-1008. Please read this instruction booklet as it contains valuable information on how to properly fly and care for your PA-1008.

## FEATURES

- Air Pressure Sensor Locks Flight Altitude
- Built In 6 Axis Gyroscopic Chip Keeps the PA-1008 Extremely Stable in All Conditions
- T (Training ) Mode Helps Beginner Pilots Learn How to Fly
- Automatically Start and Lands with The Push of A Button
- Different Speed Settings for Slow to High Speed Flying

## REMOTE CONTROL BATTERY INSTALLATION

1. Unscrew and remove the battery cover from the back of the remote control.
2. Install 2 "AAA" alkaline batteries into the battery compartment as shown in the diagram A1.
3. Replace the battery cover and secure it.

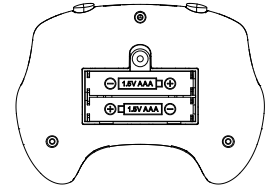

## CHARGING THE PA-1008

1. Before playing, you need to charge the PA-1008 battery first. Connect the charging socket of USB charging cord to the charging plug on the battery side. (See diagram A)  
**Caution: The USB plug fits the charging socket only in one way. Do not force it.**
2. Connect the PA-1008 charging cord to your computer's USB port (see diagram B).  
**Caution: Only use this charging cord with a computer USB port! Do not attempt to use other USB charging devices.**
3. The red LED on the USB plug lights up when charging is complete (See diagram C).  
**Note: If the red LED lights up, either the charging is complete or the USB plug is not properly connected.**
4. The average charging time is approximately 35-40 minutes. The PA-1008 operates for about 5 minutes per charge.  
**Low battery indication: the PA-1008's LED lights will begin to flash to notify you that the battery is running low. 45 seconds after the LED lights start flashing your PA-1008 will automatically land to the floor.**

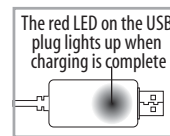
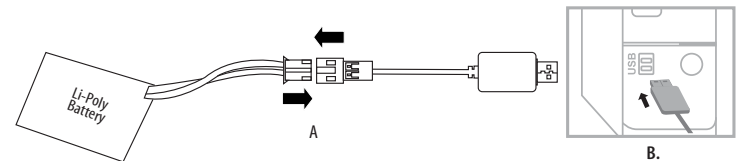
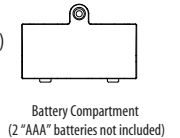

C

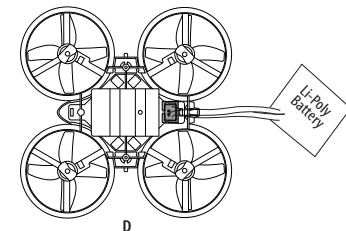

D

## PA-1008 DIAGRAM

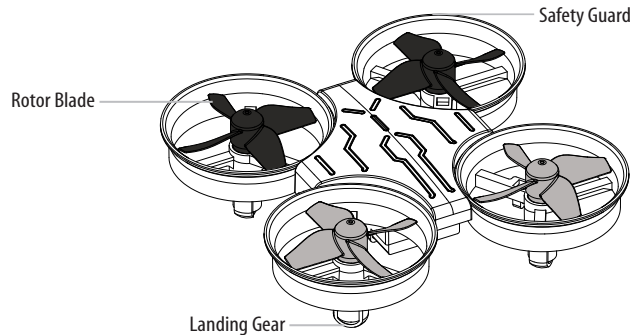

## REMOTE DIAGRAM

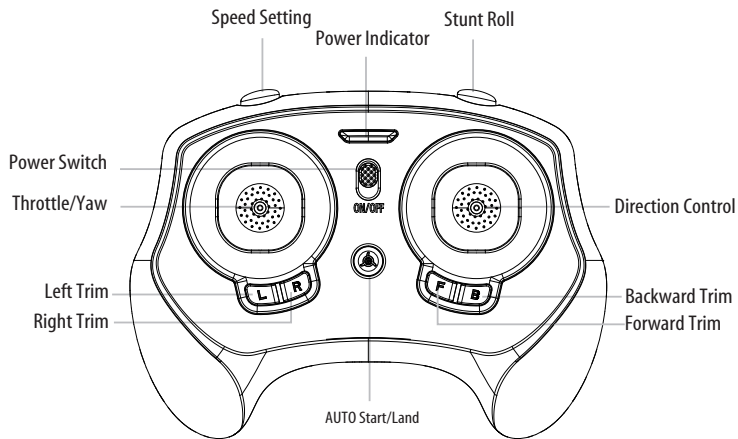

## WARNING

**DO NOT FLY YOUR PA-1008 IN FOUL WEATHER!**



## PREPARING FOR FLIGHT

- Verify that there are 2 “AAA” batteries inside the remote control unit and the PA-1008 has been fully charged.
  - Make sure to be in a large space with an open radius of at least 50 feet.
  - Make sure the empty space has no obstacles or rivers. Set your PA-1008 on a clean flat surface before take-off.
- DO NOT ATTEMPT TO FLY YOUR PA-1008 IF THERE IS RAIN, SNOW, HEAVY WINDS, THUNDER OR LIGHTNING OUTDOORS. IT COULD DAMAGE YOUR PRODUCT AND POSSIBLY EVEN CAUSE BODILY HARM.**

## SYNCING YOUR PA-1008

**Important!** When syncing your PA-1008 drone with the controller always make sure that the drone is on a flat level surface. This insures that the 6-axis gyro is properly programmed to mimic your trim settings.

Your PA-1008 utilizes an automatic 2.4G channel selection system that allows up to 8 people to fly side by side in the same wireless range.

### For One-person Play:

1. Before starting, make sure that both your controller and PA-1008 are powered off. Make sure that there are no other 2.4G devices in the area as well.
2. Connect the battery into your PA-1008 and set it down on a flat level surface. The white and red LED indicators of the PA-1008 should start flashing rapidly.
3. Turn ON your remote and you will hear 1 short beep, the white and red LED lights will start flashing slower. Push the throttle all the way up then pull it all the way down. You will hear one long beep and the LED lights will turn solid. Your PA-1008 and remote should have successfully synced. Should this not happen, repeat all steps again.

### For Multi-person Play:

4. Before starting, make sure that all PA-1008s and Controllers are powered off. Make sure that there are no other 2.4G devices in the area as well.
5. Each person will have to sync their PA-1008 individually at a different time to avoid interference. Follow steps 1 to 3 above, making sure to keep away from other people while also making sure that no one else is syncing at the same time.
6. After syncing one player's PA-1008, it should be left ON until all players have synced their PA-1008s.
7. Should there be a mistake/interference, all players must turn off their controllers and PA-1008s and start the process all over again.

## FLYING TIPS

- It is recommended that you operate the PA-1008 in a wide space. The ideal space should have a 61 m/200 ft radius.
- Parental guidance or adult supervision is suggested at all times.
- If you are flying the PA-1008 with others, make sure all spectators are behind you.
- For best performance, it is recommended that you operate the PA-1008 in zero wind conditions. Wind can greatly affect the performance of the PA-1008.

## NOW YOU ARE READY TO FLY!

If you have successfully synced your PA-1008 to your controller as explained on page 4 you are now ready to fly. Before beginning to fly your drone you should familiarize yourself with how to start and stop the rotors, how to use your take off and auto land feature and how the controls work. please carefully read and familiarize yourself with various control features explained in the next few pages. Once again as a beginner pilot you should learn how to control your drone in a large open field or park on a day with zero or very light wind. Do not try to fly your PA-1008 too high until you become a more experienced pilot.

## RECOGNIZING THE FRONT AND REAR OF THE PA-1008

Even though the PA-1008 has four rotors there is still a front or forward-facing direction and back or backwards-facing direction. The Front and forward-facing direction of the PA-1008 is the side with two grey propellers. The rear and back of the PA-1008 is the side with two black propellers and where the battery compartment is. The PA-1008 when in flight will also help you keep aware of the orientation with lighted LED lights in the arms of the PA-1008.

**NOTE:** The front of the drone displays WHITE LED light and the back of the drone displays RED LED light.

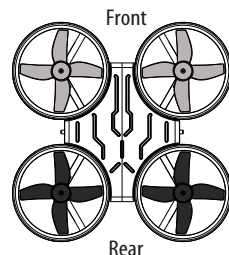

## AUTOMATICALLY TAKE OFF / LAND

Make sure you have properly synced The PA-1008.

- simply press the Auto Start/Land button, your PA-1008 will automatically take off.
- To stop or land the PA-1008 just Press the Auto Start/Land button again and the PA-1008 will descend and land automatically.

**Tips:** You also can move the two control sticks simultaneously down inside or outside corners, hold them till you hear a “beep” and the blades start spinning. Release the control sticks and push the throttle stick slowly to take off manually.

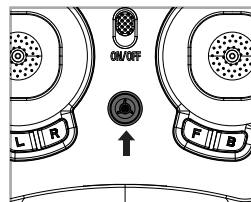

## UNDERSTANDING THE ALTITUDE LOCK

The PA-1008 has a unique Altitude Lock function. With the help of air pressure sensor you can control, your PA-1008 more stable than ever. The sensor locks in the altitude of the drone while allowing the user to adjust the directional control without having to hold the throttle. After starting the drone, fly upwards to a safe height. Once at a safe height, let go of the throttle control, your PA-1008 should lock in the altitude and allow the user to focus on getting used to the directional controls.

**NOTE:** The altitude sensor does have some tolerance based on atmospheric conditions and could have a slight variation in altitude.

## SPEED SETTING BUTTON

The PA-1008 has 4 speed Modes; **T(Training)**, **1(SLOW)**, **2(MEDIUM)** and **3(HIGH)**. The Default setting when you first turn on your PA-1008 is **1(SLOW)**. Short press speed button you can switch among the 3 speed settings.

## T (Training)MODE

Simply press and hold the Speed Button, you will hear a long beep indicating you are in T Mode now. T mode allows you to learn how to operate your PA-1008 at a very slow speed. Also there are maximum and minim height limits set to avoid crashing to ceiling or floor in T mode. To exit T mode just press the speed setting button again.

## UNDERSTANDING TRIM ADJUSTMENTS

### Forward/Backward Trim

- If your PA-1008 is moving forwards or backwards automatically, you may need to adjust the FORWARD/BACKWARD TRIM buttons.
- If your PA-1008 flies forward, push and release the Backward TRIM button repeatedly until the moving stops and proper flight is maintained.
- If your PA-1008 flies backwards, push and release the Forward TRIM button in the same manner until the problem is resolved.
- From time to time you may have to adjust the FORWARD/BACKWARD TRIM to ensure the PA-1008 will hover in mid-air and respond accurately to your commands.

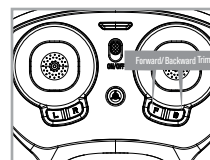

Forward/Backward Trim Controls

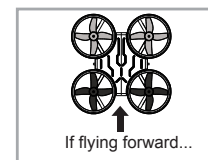

If flying forward...

Push backward trim button

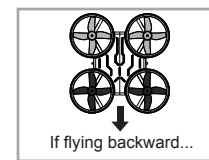

If flying backward...

Push forward trim button

### Banking Left/Right Trim

- If your PA-1008 is not steadily hovering and is banking to the left or right automatically, you may need to adjust the BANKING TRIM buttons.
- If your PA-1008 banks to the left, push and release the R Trim button repeatedly until the banking stops and proper flight is maintained.
- If your PA-1008 banks to the right, push and release the L Trim button in the same manner until the problem is resolved.
- From time to time you may have to adjust the BANKING TRIM to ensure the PA-1008 will and respond accurately to your commands.

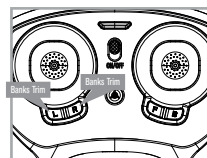

Left/Right Banking Controls

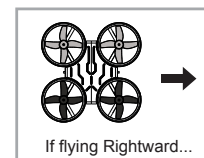

If flying Rightward...

Push the “L” trim button to increase left banking sensitivity

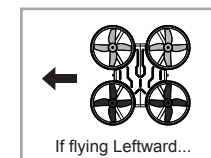

If flying Leftward...

Push the “R” trim button to increase Right banking sensitivity

**NOTE:** The use of the Trim buttons are accompanied with a beep tone. A single long beep indicates the product is centre-trimmed. No beeping after press the trim button indicates the product is trimmed to the maximum on a particular side.

### 3/4 CHANNEL SELECT

PA-1008 allows you to control your quadcopter in 3 channel mode (beginner) or 4 channel mode (advanced flying). The PA-1008 default setting is 4 channel mode.

To change to 3 channel mode:

PRESS the Direction Control stick vertically down then release, you will hear 3 short beeps indicating the PA-1008 now is set to 3CH mode.

To change back to 4 Channel mode:

PRESS the Direction Control stick vertically down then release again, you will hear 4 short beeps indicating the PA-1008 is now set to 4CH mode.

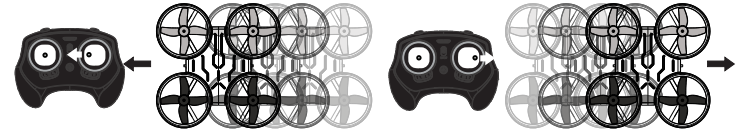
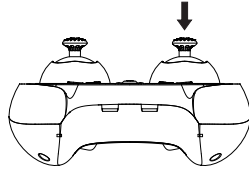

Move the Direction Control left and the PA-1008 will bank to the left.

Move the Direction Control right and the PA-1008 will bank to the right.

### 4 CHANNEL FLIGHT CONTROL



Move the Throttle up to increase the speed of the motors and the PA-1008 will rise up.



Move the Throttle down to decrease the speed of the motors and the PA-1008 will descend.

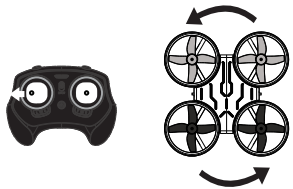

Move the Throttle stick left and the PA-1008 will rotate left.

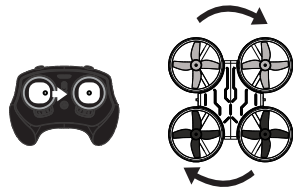

Move the Throttle stick right and the PA-1008 will rotate right.

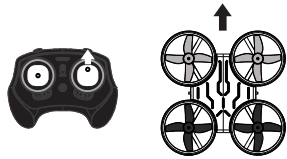

Move the Direction Control up and the PA-1008 will move forward.

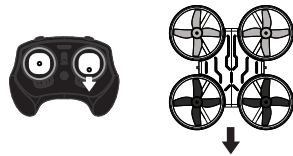

Move the Direction Control down and the PA-1008 will move backward.



Move the Throttle up to increase the speed of the motors and the PA-1008 will rise up.

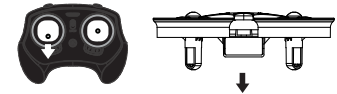

Move the Throttle down to decrease the speed of the motors and the PA-1008 will descend.

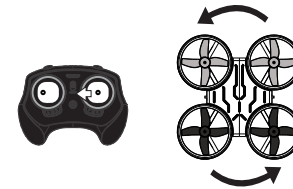

Move the Throttle stick left and the PA-1008 will rotate left.

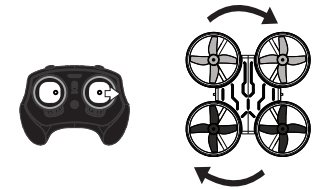

Move the Throttle stick right and the PA-1008 will rotate right.

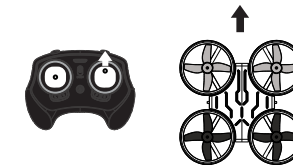

Move the Direction Control up and the PA-1008 will move forward.

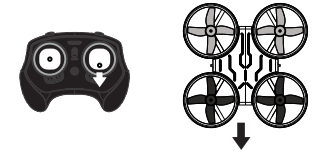

Move the Direction Control down and the PA-1008 will move backward.

## CALIBRATING THE PA-1008

If the PA-1008 becomes unstable during the course of flying, you may need to calibrate the internal gyros. To do this place the PA-1008 on a flat level surface. Do not start the blades. Instead move both the throttle and control stick down and to the right corner. The LEDs on the PA-1008 will flash quickly and then remain solid, this indicates your drone has been recalibrated (see diagram E).

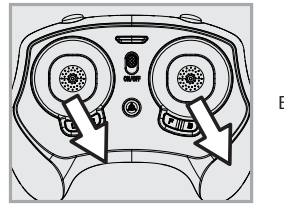

## HOW TO DO 360° STUNT ROLLS

1. In order to make your PA-1008 do 360° rolls you must fully charge your battery.

Note: The PA-1008 will not do 360° stunt rolls in T mode and Mode 1 or under low battery indication (The LED lights on the drone will be flashing).

2. Once you are ready to attempt a 360° roll, simply depress and let go of the "STUNT" button on the top right hand side of your controller (see Remote Diagram on page 3). You will hear beeping sounds, this means you are now in "STUNT MODE."

3. Now quickly move your right control stick in any of 4 directions; up, down, left or right. Your PA-1008 drone will instantly roll in the associated direction. See diagram below.

Note: After performed the stunt roll, the beeping sounds will stop. Repeat step 2 to 3 if you wish to do it again.

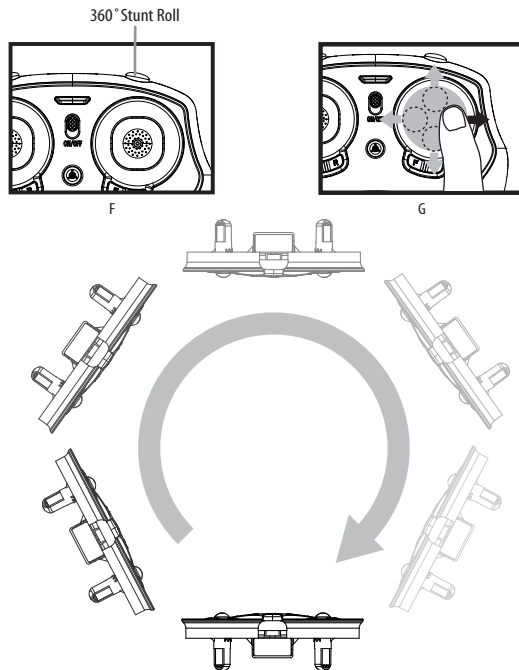

## PA-1008 WARNING:

The PA-1008 is designed for INDOOR and OUTDOOR use. The PA-1008 blades revolve at high speeds and can cause damage to the user, spectators and animals. Stand away from the PA-1008 to reduce the risk of getting into the flight path. Warn spectators that you will be flying your PA-1008 so that they are aware of its position. Before flight, inspect the rotor blades to make certain that the blades are securely fastened to the PA-1008.

### WARNING!

- Choking/Cutting Hazard. Small Parts/Sharp Rotor Blades.
- Keep hands, hair and loose clothing away from the propeller when the power switch is turned to the ON position.
- Turn off the transmitter and PA-1008 power switches when not in use.
- The included charger is built specifically for the PA-1008 Li-Poly battery. Do not use it to charge any other battery.
- New alkaline batteries are recommended for maximum performance.
- Parental supervision recommended when flying PA-1008.

## BATTERY WARNINGS

### RECHARGEABLE BATTERY:

This PA-1008 uses a Li-Poly rechargeable battery. If battery no longer stays charged, dispose of battery properly according to local disposal requirements.

### CONTROLLER BATTERIES:

Remote control requires 2 "AAA" batteries (not included). Please read the important battery safety warning below.

- Do not mix alkaline, standard (carbon-zinc) and rechargeable batteries (nickel metal hydride).
- Do not mix old and new batteries.
- Non-rechargeable batteries are not to be recharged.
- Rechargeable batteries are to be removed from the item before being charged (if removable).
- Rechargeable batteries are only to be charged under adult supervision.
- Exhausted batteries should be removed immediately and must be recycled or disposed of properly according to state or local government ordinances and regulations.
- The supply terminals are not to be short-circuited.
- Only batteries of the same or equivalent type as recommended are to be used.
- Batteries are to be inserted with the correct polarity (see inside booklet for diagram).
- Do not dispose of batteries in a fire - batteries may leak or explode.

## CARE AND MAINTENANCE

- Always remove the batteries from the wireless remote control when it is not being used for an extended period of time.
- To clean, gently wipe the remote control and PA-1008 with a clean damp cloth.
- Keep the toy away from direct heat or sunlight.
- Do not submerge the toy into water. This can damage the unit beyond repair.
- Parental guidance recommended when installing or replacing the batteries.

## REPLACING THE PROPELLER BLADE

Your PA-1008 propeller system is a precision instrument that may need repair or replacement from time to time for optimal flight function. Crash landing from high-speed aerial flights may cause damage to your PA-1008 propellers.

1. PA-1008 has four blades, two gray propellers on the front and two black propellers on the back.
2. When taking off the damaged blade, always use the included blade wrench. Refer to the instruction diagrams below. Always use mild force, be gentle!
3. When replacing the new blades, make sure to match the indicating letter embossed on the blades to the diagram below.

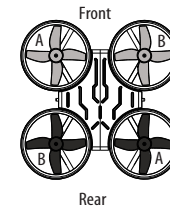
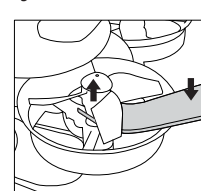

Blade Front Left = A  
Blade Front Right = B  
Blade Rear Left = B  
Blade Rear Right = A

## Limited 90-Day Warranty

NORTH AMERICA

AMAX Group USA warrants to the original consumer that this product is free from any electrical or mechanical defects for a period of 90 DAYS from the date of purchase. If any such defect is discovered within the warranty period, AMAX Group USA will repair or replace the unit free of charge upon receipt of the unit, shipped postage prepaid and insured to our warranty center ALONG WITH THE ORIGINAL RECEIPT evidencing that the product was purchased from an approved AMAX retail partner and that the product is still within the 90 day warranty period. The warranty covers normal consumer use and does not cover damage that occurs in shipment or failure that results from alterations, accident, misuse, abuse, neglect, wear and tear, inadequate maintenance, commercial use or unreasonable use of the unit. Removal of any parts/components voids all warranties. This warranty does not cover cost of repairs made or attempted outside by third-party individuals or companies. Any applicable implied warranties, including warranties of merchantability and fitness, are hereby limited to 90 DAYS from the date of purchase. Consequential or incidental damages resulting from a breach of any applicable express or implied warranties are hereby excluded. Some states do not allow limitations on the duration of implied warranties and do not allow exclusion of incidental or consequential damages, so the above limitations and exclusions in these instances may not apply.

### REPAIR/REPLACE PRODUCT

If your product begins to malfunction or stop working, immediately contact our warranty center (contact details listed below). If it is determined that a return is necessary, our warranty department will issue you an RMA number/form and an address to the nearest return center for shipping the product to us. When honoring the warranty, AMAX reserves the right to either repair, replace or refund the product.

### IMPORTANT NOTICE:

We will reject and return to sender returns that are not accompanied by an AMAX issued RMA form and RMA number so make sure to contact our warranty center before attempting to return your product!

### PREPARATION FOR SHIPPING YOUR PRODUCT:

Please repack your product in a durable box, preferably in the original carton, and send it prepaid, and adequately insured. Include the RMA form that was issued by our warranty department along with your daytime telephone number and email address inside the shipping carton. If your warranty has expired and you still require service please contact our customer care team. For further information please send all inquiries to: [customer care@amaxbrands.com](mailto:customer care@amaxbrands.com)

**IMPORTANT NOTICE!**  
**DO NOT ATTEMPT TO SHIP YOUR PRODUCT BACK WITHOUT FIRST CONTACTING OUR WARRANTY DEPARTMENT AT:**

[www.amaxbrands.com](http://www.amaxbrands.com)

Email: [care@amaxglobal.com](mailto:care@amaxglobal.com)

Phone 1-866-360-1510

### INDUSTRY CANADA NOTICE: CANADA ONLY.

This device contains licence-exempt transmitter(s)/receiver(s) that comply with Innovation, Science and Economic Development Canada's licence-exempt RSS(s). Operation is subject to the following two conditions:

1. This device may not cause interference.
2. This device must accept any interference, including interference that may cause undesired operation of the device.

L'émetteur/récepteur exempt de licence contenu dans le présent appareil est conforme aux CNR d'Innovation, Sciences et Développement économique Canada applicables aux appareils radio exempts de licence. L'exploitation est autorisée aux deux conditions suivantes :

1. L'appareil ne doit pas produire de brouillage;
2. L'appareil doit accepter tout brouillage radioélectrique subi, même si le brouillage est susceptible d'en compromettre le fonctionnement.

Hereby, [Amax Group], declares that this [PA-1008] is in compliance with the essential requirements and other relevant provisions of Directive 2014/53/EU.

The full text of the EU declaration of conformity is available at the following internet address:

[www.amaxbrands.com](http://www.amaxbrands.com)

For 2.4G Remote controller and Drone

For remote controller

Frequency Bands: 2407MHz-2461MHz

Max. power transmitted: -16.42dBm

For Drone

Frequency Bands: 2407MHz-2461MHz

Max. power transmitted: -15.38dBm