

SPLASH DRONE 3

User Manual v1.3

2017.08

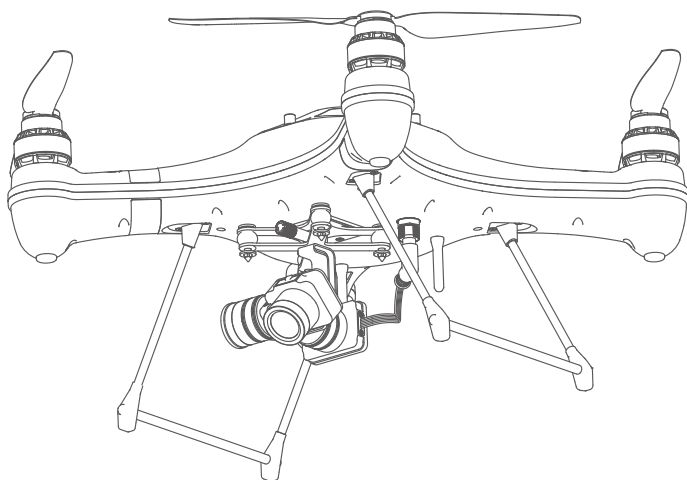

www.facebook.com/swellpro/

SwellPro

www.swellpro.com

Thank you for purchasing this SwellPro Splash Drone. We have designed and manufactured the Splash Drone to the highest quality standards, to provide you a safe and reliable product for many years. Please read the entire contents of this manual thoroughly, to comprehensively familiarize yourself with the product before using it.

Please Note: This manual is correct at the time of release, and is subject to change without notice. Please check on our website: www.swellpro.com for the latest release.

Reading Note

Icon Definitions

 Prohibited

 Important Notice

 Operation Notice

Recommended

Swellpro has prepared the following tutorial video and instruction manuals:

1. Part List
2. User Manual
3. Quick Guide
4. Disclaimer Guide
5. Battery Usage Guide

Before flying the drone, we strongly advise you to watch the tutorial videos and read through the above instruction manuals.

Where to find the tutorial videos

The tutorial videos can be found and downloaded at www.swellpro.com.

Content

Reading Note	02
Icon Definitions	02
Recommended	02
Where to find the tutorial videos	02
Product Overview	05
Brief Introduction	06
Highlighted Functions	07
Drone Assembly and Set up	08
Drone Illustrations	08
Remote Control Illustration	09
About the Drone	11
Drone Overview	12
Flight Modes	12
Indication Lights	13
Auto Return-Home Function	14
Propellers	15
Battery	16
Remote Control	19
Remote Control Overview	19
Remote Control LED Indicators	21
Conversion of the remote control throttle position	22
Remote Controller Pairing (to the drone)	23
FPV Screen	24
Waterproof Camera & Gimbal	25
Camera	26
Gimbal Calibration	28
Gimbal Accelerometer Calibration	28
Gimbal Gyroscope Calibration	29

Flight	30
Flight	31
Flying the Splash Drone	31
Flight Restrictions	31
Pre-Flight Inspection and checks	32
Accelerometer Calibration	32
Compass Calibration	33
Starting/Stopping Motors	36
Basic Flight Operation	37
Frequently Used Parts	38
Video Transmitter Channel Selection	39
Payload Release	41
APP Control	42
How to use the APP	43
Fight path setting	44
Follow Me	45
Point-to-Fly	46
Appendix	47
Specifications	48

Product Overview

This section introduces the various drone functions, how to assemble the drone, the various part names of the drone, and it's remote control.

On the water.....

In the Rain.....

Above the Water.....

Splashdrone is your solution.....

**The Splash drone 3 is the most advanced waterproof (1)drone ever released.
Its the first fully integrated modular amphibious(2) flying platform.**

Thanks to its new flight control system, its more reliable than ever.

Its brand new propulsion system with the new custom designed 620KV motors system and quick release carbon fiber propellers provides you with the perfect balance between power and efficiency.

With its new quick release modular system you can enjoy maximum versatility by quickly and easily switching between :

- 4KGC a waterproof 4K camera and 2 axis gimbal module
- PL1 the original payload release module , for simple release.
- PL2 the HD Fpv payload release module, for precise release with live video feed.
- PL3 the most advanced payload release module, with 4k camera recording and one axis gimbal, for the Ultimate precision live video feed and 4k recording capabilities.
- and many more modules to come...

Because great power and versatility requires great control, we developed a fully ergonomically designed and integrated remote controller with redesigned controls to maximize ease of use and efficiency and a gorgeous built in 5"FPV (3) screen, so you can see the live video and OSD data without any additional equipment.

The splash drone 3 allows you to operate in all weather conditions(4), in tough environments whether its over land or over sea.

With its advanced modular design it can quickly adapt to all type of missions from aerial filming to search and rescue, ocean survey, fishing and many more...

Highlighted and enhanced functions

1. A comprehensive waterproof design, it supports all weather flight, on a sunny day, a rainy day, or even if it is snowing. It can skim the surface, whilst the camera films below the surface of the water. It can land on the water, and take off again, and even withstands salty water conditions.
2. The waterproof payload release can be used to deliver up to 1kg loads, including but not limited to life-saver, lines, fishing bait etc.
3. Swellpro's 3rd generation waterproof gimbal integrated with a 4k camera, quick release design.
4. Newly designed 5.8G video transmission system, ensuring you have the best FPV flight experience.
5. Upgraded auto Return Home software, making sure you safely retrieve your drone, in the event of losing sight of it , or in an emergency situation.
6. Brand new, ergonomically designed remote controller, which comes with a 5" FPV screen, you can now see live video and OSD data on the screen.
7. New data link, together with a new APP version, which brings more a stable and user-friendly smart flight experience.
8. Smart cruise flight mode making it easier for you to film moving objects.
9. Brand new design quick release carbon fiber propellers, strong and durable, a perfect match for the power system.
10. High quality smart balance charger supports charging the drone's battery, and the remote controller's battery, designed to also protect your batteries, thereby creating a longer useable life.
11. Compact design carry case, easy to carry, to effectively protect and store your drone.

Drone Assembly and Set Up

Preparation of the drone

Installation of the landing gear

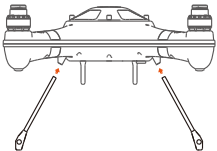
Installation Diagram	Detailed Description
	<p>Insert the landing gear according to the red arrow. (Tutorial video is available for detailed operations)</p>

Gimbal Installation

⚠ Attention: Please install the camera gimbal after completing the calibrations on Splash Drone, to avoid unnecessary rotation & tremble. (Refer to the accelerometer calibration and compass calibration on pg 29 & 30 for more details)

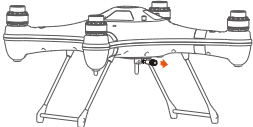
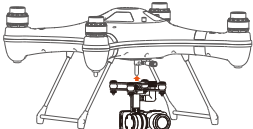
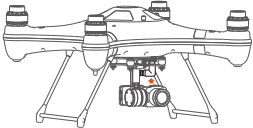
Installation Diagram	Detailed Description
	<p>Loosen the screw on the underside of the drone.</p>
	<p>Mount the gimbal on the bottom plate, and secure it with the fixing screw.</p>
	<p>Insert the gimbal cable into the corresponding plug on the underside of the drone, and tighten the waterproof cap on the plug.</p>

Drone Illustration

⚠ Note: When opening the top cover, be careful of the GPS cable, When closing the top cover, please make sure to place the hatch in such a way that the arrow faces the front of the drone.



⚠ Before closing the GPS Top cover, please make sure that the watertight gasket and the sealing surfaces on the drone are in good condition and are free of dirt, sand or any other contamination. Sand & other foreign materials will greatly influence the integrity of waterproof seal on the Splash Drone.

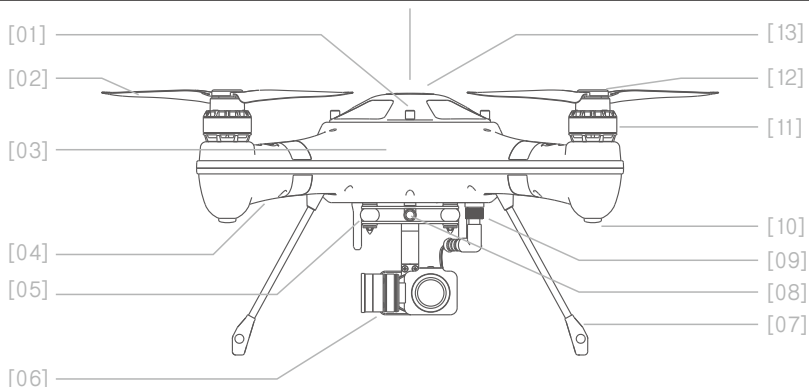

- | | |
|--|-----------------------------------|
| [01] Cover/hatch screw | [07] Landing gear |
| [02] Quick release carbon fiber propeller | [08] Gimbal quick release screw |
| [03] Nose direction | [09] Waterproof cable plug/socket |
| [04] Flight indication lights
(Front – 2 Red, Rear – 2 Green) | [10] Rubber foot |
| [05] Gimbal damping ball | [11] Waterproof brushless motor |
| [06] Waterproof gimbal and camera | [12] Propeller Spinner |
| | [13] GPS top cover/hatch |

Remote controller illustration

Power Button

Auto powers on the FPV screen, but can be manually powered off.

Auto search/Menu Select

Use the auto search function to select the most suitable channel / Switch between the different menus

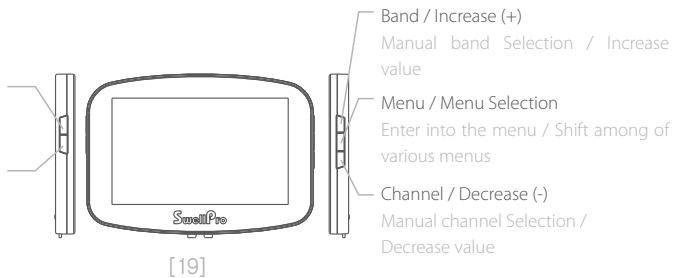

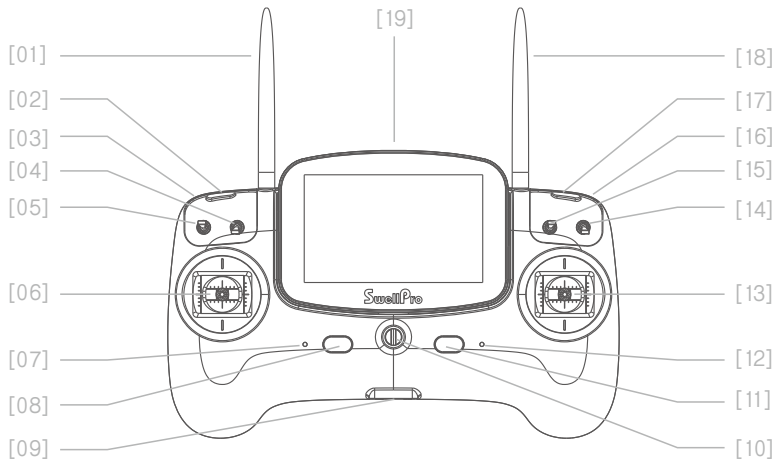

- | | | |
|--|---|---|
| [01] Remote Antenna
For drone operation signal | [08] Left power button
Press the left and right power buttons simultaneously to power on the controller | [14] Return-Home switch
Commands the drone to return automatically |
| [02] Left pairing button
Bind the RC with drone | [09] USB Port
For remote control firmware upgrade use | [15] Flight mode switch
GPS / Cruise Flight / ATTI |
| [03] Gimbal pan control thumbwheel
Adjust the gimbal PAN axis | [10] Hanger ring
For securing the lanyard to the controller | [16] Gimbal tilt control thumbwheel
Controls the gimbal tilt axis |
| [04] Camera switch
Controls the camera to take pictures, or record videos | [11] Right power button
Press the left and right power button simultaneously, to power on the controller | [17] Right pairing button
Bind the RC with drone |
| [05] Airdrop switch
Controls the payload release | [12] Power status lights
Displaying the remote controller's battery status | [18] Video antenna
Transmits FPV live video |
| [06] Left Joystick
Control the drone's ascend, descend / left or right turn | [13] Right joystick
Controls the drone for forward, backward, left and right flight | [19] FPV screen
Displays FPV live video |
| [07] Working Status lights
Remote control working status | | |

⚠ Before powering on the controller, please be sure to put all the toggle switches on the controller (Airdrop Switch, Camera Switch, Mode Switch and Return Home Switch) in the up position, failure to do so, will result in the controller continuously sending out a warning tone.

About the drone

This section introduces the drone, and its functions.

Drone Overview

The drone mainly comprises of the following systems:

- Flight control system,
- Communication system,
- Positioning system,
- Power system including the battery, ESC, motors and propellers.

Flight Modes

The Splash Drone 3 utilizes a brand new flight control system, incorporating 3 of the best flight modes.

GPS mode: This uses the GPS modules to achieve accurate and stabilized hovering, intelligent flight, intelligent return and other intelligent flight mode functions. Maximum flight speed of 10m/s, maximum ascend speed of 4m/s, and maximum descend speed of 3m/s.

Smart Cruise: Specially designed for smooth aerial filming. The turning function of left joystick is disabled, and is mixed into the right joystick, thereby freeing up your left hand, with the other hand to used control the drone's direction, and flight path.

ATTI mode: This mode does not use the GPS positioning function, but still maintains attitude stabilization.

Note: With a good GPS signal, intelligent return can be achieved. A maximum flight attitude angle of 25 degrees, a maximum flight speed of 16m/s, a maximum ascent rate of 4m/s, and the maximum descend rate of 3m/s.

 Please Note: In ATTI mode, and the drone's speed is faster. When flying in a calm environment, the pilot should allow a minimum of 30 meters for braking distance to ensure flight safety.

 Select the preferred flight mode of the drone using the remote mode switch on the controller.

Drone Indication Lights



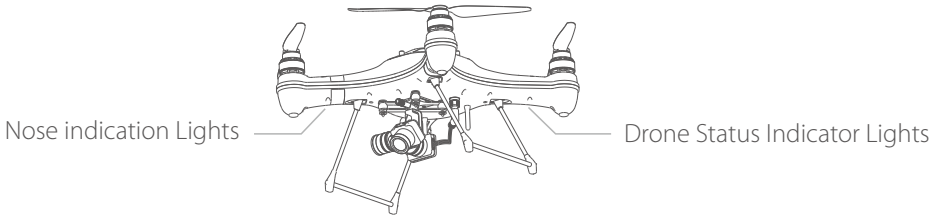





The fuselage of the drone includes a pair of nose LED indicator lights, and the drone status indicator lights on the rear arms. Their positions are shown below:



The nose LED indicator lights are used to indicate the direction of the nose of the drone. The rear aircraft status indicator lights indicate the status of the current flight control system. Please refer to the following table for the different flash modes for the flight control system.



Drone status indicator

Flight Mode		
● x1	One Green Flash	ATTI Mode
● x2	Two Green Flashes	GPS Mode
● x3	Three Green Flashes	Circling flight & Smart Cruise (Optional)
● x4	Four Green Flashes	Cruise Flight
●	Green Fast Flashing	APP control/ Return Home
GPS Status		
● x3	Three Red Flashes	No GPS connection, or no GPS signal
● x2	Two Red Flashes	Poor GPS signal
● x1	One Red Flashes	Satisfactory GPS signal
○	No Red Flash	Good GPS signal
Low battery warning		
● x3	Three Yellow Flashes	First level low battery warning, safely land as soon as possible.
●	Yellow Fast Flashing	Second level low battery warning, the drone will start it's auto landing sequence.
Two-Sided compass calibration		
● —	Yellow ON	Horizontal Calibration
● —	Green ON	Vertical Calibration
● —	Red ON	Calibration Failure
● ● ●	Alternating - Red, Green, Yellow slow flashing	Calibration Success
Six-Sided Compass Calibration		
● ● ●	Alternating - Red, Green, Yellow slow flashing	Busy with calibration process

	Return Normal Status	Calibration Success
Accelerometer Calibration		
	Alternating - Red, Green, Yellow slow flashing	Busy with calibration process
	Green ON	Calibration Success
Warning & Abnormal		
	Red - Fast Flashing	Lost radio signal
	Yellow, Green alternate slow flashing	Compass is interference / Abnormal
	Alternating Red & Green - slow flashing	Lost GPS signal, GPS abnormal
	Alternating Red and Yellow - slow flashing	IMU vibration has exceeded its limits, or is Abnormal
Other		
	Red, Green, Yellow alternate slow flashing	Indicates initialization process after powering on
	Red ON	Unlock Failure

Return HOME

Splash Drone 3 has an auto return home function. If the GPS successfully recorded the return point before takeoff, and, if the remote controller and the aircraft loose communication with each other, the drone will automatically return to the landing point, and land. Splash Drone 3 provides two auto return home modes, they are: one key return and failsafe return.

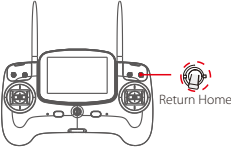

Return Point	GPS	Description
		During take off, or during the flight process, the GPS signal should be greater than 6 satellites, the drone will save the current position as the return point. When taking off in GPS mode, it is recommended that the GPS satellite count is greater than 9 satellites.

One Key Return Home Function

Remote Control	Description
	Turn the Return Home switch to Return Home position, the drone will activate its return home mode. In this mode, the drone will automatically return to the home point.

⚠ Note: During the return process, only the (right) steering stick can be controlled. When the drone returns to the point of departure, and commences its descent, the left joystick will only control the direction (Heading) of the drone, the right joystick controls the forward/back and sideways functions, in order to select and land at the chosen landing point. If you need to take control of the drone, you need to switch the Return Home switch to Normal position.

Return Process

Flare maneuver	Description
	<p>Vertical height > 20metres, horizontal distance > 15metres, drone will maintain same altitude and return to its home point.</p>
	<p>Vertical height < 20metres, horizontal distance > 15metres, drone will ascend up to 20metres, and return to its home point.</p>
	<p>Vertical height < 10metres, horizontal distance < 15metres, the drone will maintain its altitude, and return to it's home point.</p>

⚠ If the GPS signal is poor (Value is less than 5) or GPS doesn't work, the Return Home function will not be available.

Failsafe Return Home

If the drone goes out of effective distance, the Return Home function will be activated automatically. When the remote control communication is recovered, the control of the drone can be resumed after a single switching of the flight mode Switch, regardless of the current mode is under ATTI or GPS.

Propeller Installation

Installation / Removal

Hold the rotor of motor tight while supporting the arm upwards with the other hand, take the corresponding propeller to install. Press the propeller spinner hard and rotate to fasten it properly. It's available to remove the propeller in the opposite way.

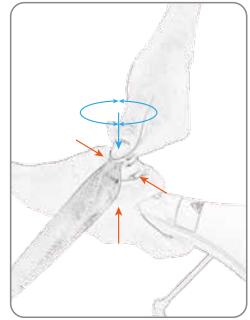

Propeller	CCW Propeller	CW Propeller
Picture		
Installation	Install on the CCW motor	Install on the CW motor
Direction	 CCW Propeller Slot CW Propeller Slot	

- ⚠ The blades are sharp, please be careful to avoid accidental cutting or scratches.
- ⚠ When installing or removing the propellers, please place your free hand under the motor, so as to provide support and a back force when pushing down to lock or unlock the propeller. Failure to provide this support could result in the bending or breaking of the landing gear.
- ⚠ Prior to each flight, please check that the propellers are correctly installed and securely fastened.
- ⚠ If a propeller becomes damaged, or broken, please replace it, they can be purchased separately.
- ⚠ Please do not get too close to the rotating propellers and motors, to avoid cuts or injury.
- ⚠ Please use the propellers provided by Swellpro, they cannot can be mixed with different types of propeller

Battery

Before use, please fully charge the drone battery, and the remote battery.

Charging

1. Connect the charger to an AC power supply (100-240V, 50/60Hz), and then connect the charger to the drone battery, or the remote control battery, as applicable.
2. After powering on the balance charger, all the LEDs will flash for 1 second, connect the battery to the balance charging port, now the battery can be charged.

3. Indication lights: One LED on indicates a charge level of 25% , two LEDs on indicate a charge level of 50%, three LEDs on indicate a charge level of 75%, four LEDs indicate that the battery is fully charged.

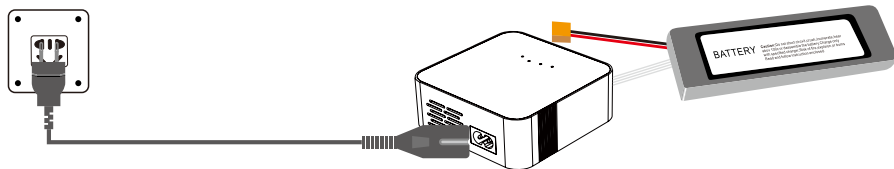

-
- ⚠ Before charging, please ensure that you are using the correct battery type.
 - ⚠ If, during the charging process, the 4 indicator lights flash at the same time, this indicates a charger or battery failure, please stop charging.
-

Battery Installation

When inserting the battery, please take note and observe the following precautions:

- Please ensure the battery is "lying on it's side" with the cables exiting the battery towards the rear of the drone,
- Please observe the label on the battery.
- Please observe the instructions and the arrow on the label.

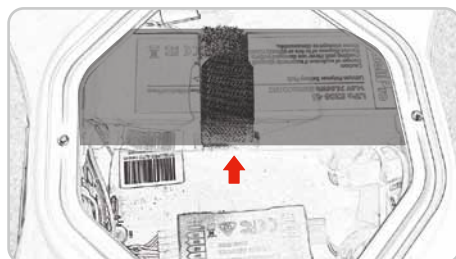

-
- ⚠ There are two low battery alarms, which can be set by adjusting the parameters in the setup. The first level is at 14.8V, the red LED on the drone will flash three times, the second level is at 14.4V, at this level, the red LED will flash continuously, while the drone will commence its auto landing sequence.
 - ⚠ Please Note: There are no low battery alarms on the controller.
While operating the drone, please monitor the battery voltage level, and keep the voltage level in mind, when the level has dropped to 14.8V, please prepare to return the drone to a safe landing place.
 - ⚠ It is dangerous to continue flying the drone once with insufficient battery power. This could result in damage to the battery.
-

Low temperature precautions

1. In low temperature environments (-10C degrees to 5C degrees) , the flight time will be reduced. Before use, please fully charge the battery, and keep it warm.
2. In low temperature environments, it is recommended to stop flying if and when the low battery alarm is on.
3. In low temperature environments, it is recommended to preheat the battery before flying.

Remote Control

This section introduces the remote control functions. Including the drone operation, and the camera operation.

Remote Control Overview

The Splash Drone3 remote control operates using two frequency bands, 2.4GHz and 5.8GHz. 2.4GHz is for the drone control, and 5.8GHz is for the FPV video signal. The remote controller is integrated with the camera and gimbal controls, which is convenient for the user to easily maintain comprehensive control during flight, and can easily shoot wonderful videos or pictures.

⚠ The default remote control configuration is left hand as throttle. If you prefer to have right hand throttle, please consult your local dealer.

Remote Control

Press down and slide open the battery cover to open it, install the remote control battery and replace the cover.

Remote Control Operation

Power ON and Power OFF

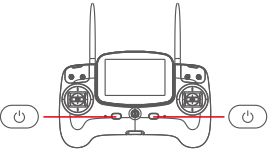
Remote Control Operation	Description
	<ol style="list-style-type: none">1. Simultaneously press the two power switches for about 3 seconds, the remote control will power on, and the screen will turn on.2. To turn off the controller, simultaneously press the two power switches for about 3 seconds again, the remote control will power off, and the screen will turn off.

Airdrop Switch

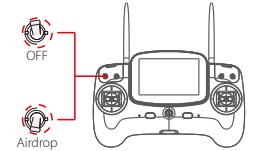
Remote Control Operation	Description
	<p>OFF: Close Airdrop Airdrop: Open</p>

Camera Control

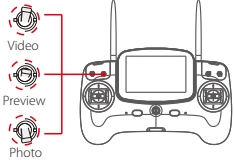
Remote Control Operation	Description
 <p>The diagram shows a top-down view of a remote control. Three red circular icons with camera symbols are positioned to the left of the remote. Red lines connect these icons to specific buttons on the remote: the top icon to the top-left button, the middle icon to the top-right button, and the bottom icon to the bottom-left button.</p>	<p>Video: Shoot Video Preview: Preview Photo: Take Picture</p>

Flight Mode

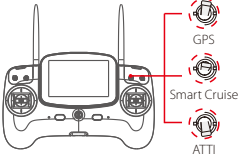
Remote Control Operation	Description
 <p>The diagram shows a top-down view of a remote control. Three red circular icons with different symbols are positioned to the right of the remote. Red lines connect these icons to specific buttons on the remote: the top icon to the top-right button, the middle icon to the bottom-right button, and the bottom icon to the bottom-left button.</p>	<p>GPS: GPS mode Smart Cruise: Smart Cruise Mode ATTI: ATTI mode</p>

One Key Return Home

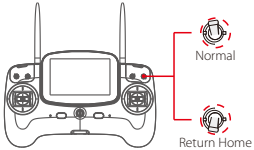
Remote Control Operation	Description
 <p>The diagram shows a top-down view of a remote control. Two red circular icons with different symbols are positioned to the right of the remote. Red lines connect these icons to specific buttons on the remote: the top icon to the top-right button and the bottom icon to the bottom-left button.</p>	<p>Normal: Return Home is disabled Return-Home: Activate Return Home</p>

Gimbal Control

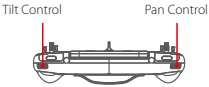
Remote Control Operation	Description
 <p>The diagram shows a top-down view of a drone's gimbal. Two red circular icons with different symbols are positioned above the gimbal. Red lines connect these icons to two thumbwheels on the gimbal: the left icon to the left thumbwheel and the right icon to the right thumbwheel.</p>	<p>Tilt Control Thumbwheel: Controls the gimbal tilt axis Pan Control Thumbwheel: Controls the gimbal pan axis</p>

Drone Control

Mode 1 (Left hand throttle-American/ European configuration)

Left Stick

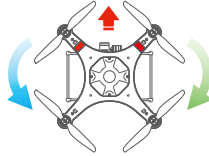
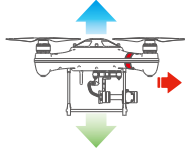

Right Stick

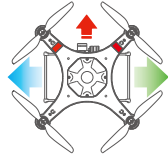
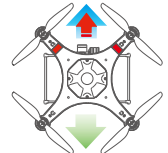
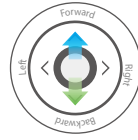

Mode 3 (Right hand throttle-Japanese configuration)

Left Stick

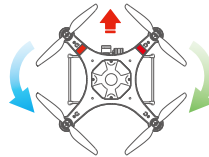
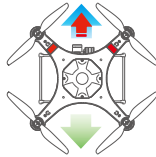

Right Stick

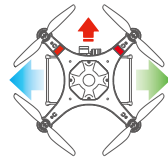
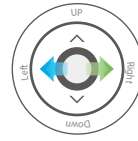
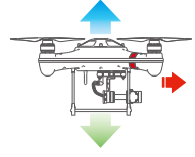
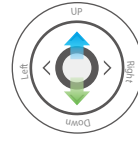

Remote Control LED Indicators

Working Indicator	Power Status Indicator	Warning Tone	
	RED Light ON	Yes	Remote Control battery low
	RED Light slow flash	Yes	Remote Control battery is dangerously low
Light Stays ON			Status is good
Slow Flash	Light Stays ON		Remote control and receiver disconnected
Fast Flash		Success tone	Paring

⚠ When the remote control battery power is seriously insufficient, the remote control power indicator light will slowly flash a red light whilst sounding a warning tone. Please charge or replace the remote battery as soon as possible.

Conversion of the remote control throttle position

The Remote control's default joystick configuration is the American/European - Left handed throttle, it can however, be set to the Japanese configuration, which is right hand joystick is the throttle/yaw control.

Remote Control Joystick conversion method :

There are 2 choices for the joystick configuration, either left handed throttle, (American/European mode) or Right hand joystick used as throttle (Japanese mode.)

Procedure: With the controller in the OFF status and all switches in the up position.

Both sticks top right then press both power buttons on.

Press the left pairing button and the left led will flash once for mode 1 , flash 2 times for mode 2 and 3 times for mode 3 and 4 times for mode 4.

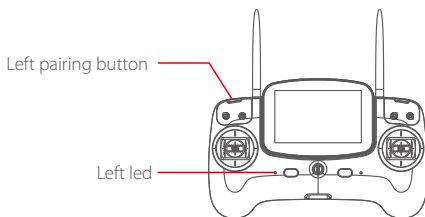

Joystick configuration	The left led will flash
Mode1 : Left hand throttle	1 Green Flash
Mode2: Not used	2 Green Flashes
Mode3: Right hand throttle	3 Green Flashes
Mode4: Not used	4 Green Flashes

⚠ After the success of the right throttle setting, the right joystick is the throttle and roll, the left joystick is the Yaw and pitch.

Remote Control Joystick calibration method

1. Using the left hand index finger, hold the left joystick in the lower left position at 45 degrees.
 2. Using the right hand index finger, hold the right joystick in the lower left position at 45 degrees.
 3. Now, using both thumbs, simultaneously press the power buttons to start the controller. The left led will flash fast.
 4. Now press the button at the back of the controller on the right hand side behind the GPS and the return home switches.
 5. Actuate the left joystick to its fullest extremes into each corner
 6. Actuate the right joystick to its fullest extremes into each corner.
 7. Actuate the thumbwheels on the back of the controller to their fullest extremes.
 8. Press the button at the back right hand side of the controller to confirm and complete the calibration procedure.
- If the procedure is a success, the left hand led will flash slowly.
If the calibration is not correctly done, the left led will continue to flash fast, and a beep will sound.
9. On completion, please power down and restart the controller.

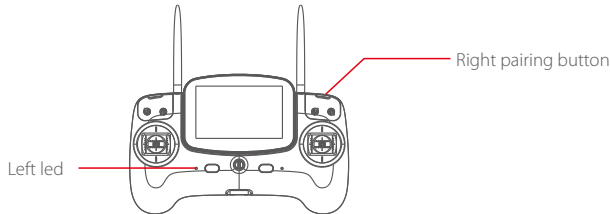

△ Remote calibration is done, with the throttle calibration

Remote Controller Pairing (to the drone)

1. Connect the jumper (which is supplied with the drone) into B/VCC channel of the remote receiver inside the drone, now power on the drone.
2. Hold the left or right pairing buttons (No.2 or 17, - diag on P9) on the remote control, until the remote control indicator becomes solid red, it indicates entry into the pairing mode. Release the button when the indicator changes to solid green. The pairing is successful.

△ When the pairing is successful, make sure to remove the JUMPER on the receiver's B/VCC channel.

FPV screen

The Splash Drone 3 uses 5.8G video transmission technology, reducing the delay to a minimum. The 5.8G transmission range can reach 1km. 40 channels are available to select from.

Display Interface

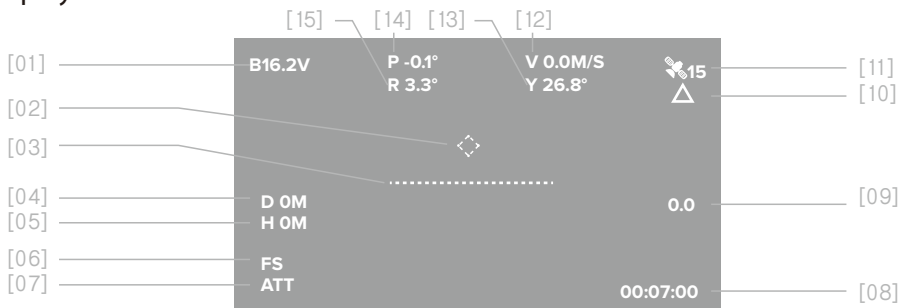

- | | |
|---|---|
| <p>[01] Battery Voltage
Drone battery voltage</p> <p>[02] Return Home direction ◀◊▶
Dynamically displays the relative angle between the nose and the return point. When the mark is displayed in middle of the FPV screen, it means the nose of the drone is facing the return point.</p> <p>[03] Flight Attitude
Verification of the flight attitude</p> <p>[04] Flight Distance
The horizontal distance between the drone, and the home point</p> <p>[05] Flight Height
The vertical height of the drone above the home point</p> <p>[06] Connection lost notice
Notification when the connection is lost between the drone and the controller.</p> <p>[07] Flight Mode
ATT: ATTI Mode, GPS: GPS Mode, CIR: Smart Cruise</p> | <p>[08] Time
The running time</p> <p>[09] Ascend speed ⬆️/ Descend speed ⬇️
The vertical speed of the drone when ascending or descending, units are metres/ second</p> <p>[10] GPS status
(☆)Not located / (△)located</p> <p>[11] Satellite Quantity
The receiving satellite quantity</p> <p>[12] Horizontal speed
The drone's horizontal speed</p> <p>[13] Angle of yaw
The actual angle of yaw</p> <p>[14] Angle of roll
The actual angle of roll</p> <p>[15] Angle of tilt
The actual angle of tilt</p> |
|---|---|

△ In the absence of obstacles, or without interference, the video transmission range can reach 1km

Gimbal & Camera

This section introduces the camera and the gimbal, and how to use them.

Camera

The camera's superior electronic image stabilization technology combined with the design of a high-precision waterproof gimbal, producing the camera's ability to shoot smooth, non-destructive and real-time videos and photos in a high-speed environment. The camera supports 24 frames per second 4K videos.

Installing the micro SD card

1. Please open the small water tight hatch on the top of the camera, insert the Micro SD card in the correct direction.
2. Close and Fasten the sealing hatch.

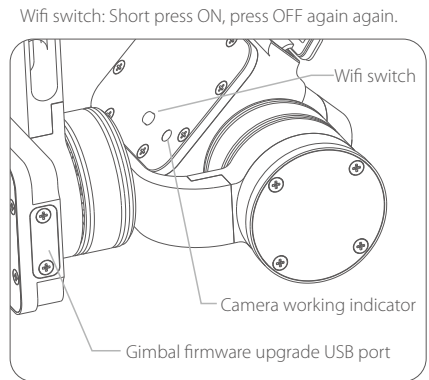
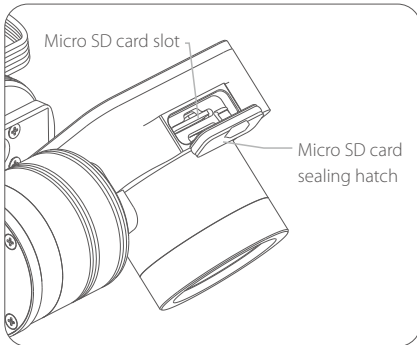

- ⚠️ Splash Drone 3 supports Micro SD card with a maximum capacity of 64GB. Because the camera requires fast reading and writing capability for high stream video data, please use a card with a minimum of Class 10 or UHS-1, or better.
- ⊘ Do not insert or pull out the Micro SD card during flight operations, this could damage or destroy the data file.
- 💡 In order to ensure the stability of the camera system, the maximum single video length limit is 15 minutes.

Camera settings and use

1. APP installation: iOS systems, for apple devices, please find the SwellCam APP in the apple store, and install the APP.

Android systems can download the APK installation on the www.swellpro.com site

2. Camera WIFI connection: Please Note, the WiFi is used for preflight setup purposes only, and must be disabled prior to take off.

Power on the drone, the camera will power on automatically, switch on the camera WIFI, the red indicator lights up indicating the camera is on. Open the WIFI on your phone, search for the name of SwellCam mobile devices, and request to connect, enter the initial password - 12345678, and connect.

3. Using the APP: Open the camera APP into the camera preview screen. On the APP, you can set the parameters of the camera and video, you can also control the camera for the taking of pictures or videos, and other related functions.

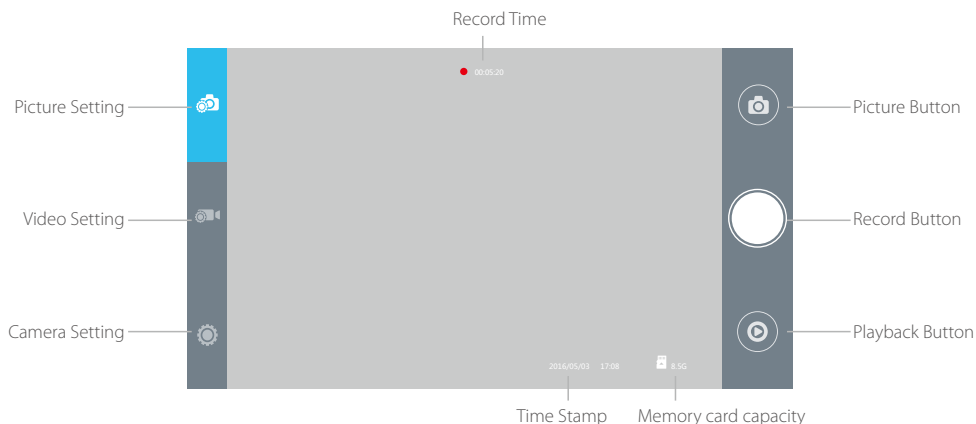

⚠ Please turn off the camera's WIFI switch before take off, so as not to interfere with the flight control or video transmission signals during flight.

Camera Setting

Picture Format	JPEG RAW J+R
Picture Size	14M 10M 5M 14M_16: 9 10M_16: 9 5M_16: 9
Time Stamp	OFF ON
Burst Speed	OFF 3pics/second
Timer	OFF 5seconds 10 seconds
Self-timer	OFF 3seconds/pic 5seconds/pic 10seconds/pic 30seconds/pic



Record Setting

Resolution	APP control:	1920*1080 P30	1920*60 P60
		1280*720 P30	1280*720 P60
	Remote Control:	2880*2160 P24	2560*1440 P30 1920*1080 P30
		1920*1080 P60	1280*720 P30 1280*720 P60
Video Format	MOV MP4		
Time Stamp	OFF ON		

⚠ Note: APP and remote control camera recording video resolution is different, please select the best resolution according to your specific needs.

System Setting	
Language	English, Chinese
Picture Flip	180°Flip, OFF
Time Setting	
WIFI Password	
ISO	AUTO 100 200 400 800 1600
EV	-2 -1.5 -1.0 -0.5 0 +0.5 +1.0 +1.5 +2.0
White Balance	AUTO, cloudy, sunny, Incandescent lamp, Fluorescent lamp
OSD	ON, OFF
Recording	ON, OFF
Video Format	PAL, NTSC
Metering	Global metering, Center-weighted, spot
Frequency	50Hz, 60Hz
Format	Sure, Cancel
Default Setting	Sure, Cancel

Camera Indicator

	Green ON	Power on into preview mode
	Green Slow Blink	Saving picture or video
	Red ON	WIFI ON
	Red OFF	Wifi Off

Gimbal Calibration

High precision two axis waterproof pan tilt angle jitter of + 0.02 degrees, even in the event of a large action flight, it can record a smooth video. The pitch angle has controllable operating range of -90 degrees to 0 degrees.

Gimbal Accelerometer Calibration

Accelerometer calibration is necessary if:

- The camera lens isn't in horizontal location, when left at it's default state.
- This will display a tilted image.

Calibration Procedure:

1. Place the drone on a horizontal surface, switch on the controller, and then power up the drone. After hearing a "DI" tone, the Gimbal is activated and ready for calibration.
2. Simultaneously roll the 2 thumbwheels for the Gimbal pan and tilt control to the left-most position, and maintain this position for 6s. After the Gimbal appears powerless, release both of the thumbwheels.

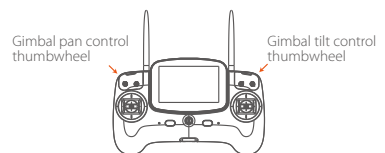

Release the quick-release mounting screw securing the Gimbal to the drone, please make sure that the waterproof plug & play connector is well-connected during the process.

3. Lower the Camera Gimbal onto a horizontal surface without any vibration, hold the Camera and keep its lens facing straight forward.

4. Roll the thumbwheel of Gimbal tilt control to the right-most position, and maintain that position for 1~2s, the Gimbal will commence accelerometer calibration automatically. When the Gimbal regains power, then release the Camera to complete the calibration process.

Gimbal Gyroscope Calibration

Gyroscope calibration is necessary if:

- When powering up the drone, the camera Gimbal is horizontal, but the image continually becomes tilted.

Calibration Procedure:

1. Place the drone on a horizontal surface, switch on the controller, and then power up the drone. After hearing a "DI" tone, the Gimbal is activated and ready for calibration.

2. Simultaneously roll the 2 thumbwheels for the Gimbal pan and tilt control to the right most, and maintain this position for 6s. After the Gimbal appears powerless, release both of the thumb wheels, the Gimbal will commence calibration automatically.

3. After the Gimbal regains power and re-balances, then the calibration procedure is complete.

After completing the calibration, please power down and restart the drone.

⚠ After completing the calibration, the gimbal will be re-stabilized, but might not be in a horizontal position, which is normal. After restarting the drone, the gimbal will revert back to its horizontal position.

⚠ During the accelerometer calibration procedure, the camera Gimbal must be placed on a horizontal surface, without any vibration. If any abnormality still persists after completing the calibrations, please power off the drone, and re-calibrate the Gimbal once again.

⚠ No limit to the ATTI mode

Flight

This section introduces and discusses flying hazards, flight restrictions, and drone care and attention.

Flight

If this is your first time wanting to fly a drone, please be sure to watch the various tutorial videos, please read the instructions and observe and digest the precautions. We recommend taking professional training and guidance. When flying, please be sure to select an appropriate flight environment.

Flying the Splash Drone

1. Please do not fly in bad weather, such as excessive wind (wind speeds of level 6, and above), fog or other extreme weather.
2. Select an open place or water surface as an ideal flying site.
Flying in between, or near a large number of steel buildings could adversely affect the workings of the compass, and will adversely affect or block the GPS signal, resulting in a poor positioning effect, or even impede, or sever communication and the ability to locate the aircraft.
3. When flying, try to maintain of line of sight with the drone, keep away from obstacles and people.
4. Do not fly near high voltage lines, communication base stations or launch towers or other areas, which may interfere with the remote control of the drone.
5. At 4000 meters above sea level, due to environmental factors, including air density, which could result in decreased performance of the drone, and it's batteries and power systems, flight performance will be adversely affected.

Flight restrictions

According to the provisions of the International Civil Aviation Organization and national air traffic control airspace control, as well as the provisions of the UAV management, UAVs must be operated in specified airspaces. In consideration of flight safety, the safety fence is the default setting.

Limited height and distance

Safety fence: has a maximum flight radius of 500 meters, and a maximum flight altitude of 200 meters. If, for any reason, you need to remove this safety fence, please refer to the Swellpro Assistant 3 reference method.

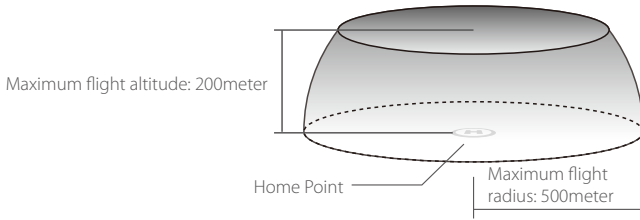

⚠ No limit to the ATTI mode

Pre-Flight Inspection and checks

1. Please ensure there is sufficient charge in both the drone and the controller batteries.
2. Please check that the propellers are correctly installed.
3. Make sure the Micro SD card is properly inserted into camera, and the sealing hatch is securely fastened.
4. Please check that the Camera & gimbal are working correctly.
5. Please make sure the camera lens is clean.
6. Please verify that the motors can be started

Accelerometer calibration

Calibration is necessary in any of the following cases:

1. First time use of the drone.
2. Following sustained flight in ATTI mode.
3. If, when pushing up the THROTTLE joystick, without moving the right (AIRLERON) joystick, and the drone drifts at an angle, while in ATTI mode.
4. If the drone has been subjected to heavy shaking during transportation.
5. If, following a successful compass calibration, the motors do unlock, but the red LED stays on solid when trying to start up the motors.

Accelerometer Calibration Steps:

1. Place the drone on a horizontal surface, power on the controller, followed by the drone, after hearing a “DI” tone, switch to “Return-Home” mode on the controller.

2. **Mode 1:** Place the left joystick into the right lower corner(45°) position, and the right joystick into the upper right corner(45°) position.

Mode 3: Move the Left joystick to the upper right corner (45 °), and the right hand joystick to the lower right corner (45 °)

3. Maintain the above gesture for 2 seconds, until the light changes to a fast blinking red-green-yellow (blinking). The drone then enters into its accelerometer calibration process. Wait until the light stops fast blinking, now release the joysticks. The accelerometer calibration is now complete.

Remote Control Operation



Mode 1



Mode 3

Compass Calibration

Please refer to the status indicator light for compass calibration. Calibration notes are as follows:



Please Note: It is recommended to calibrate the compass at the proposed flying area before flying. Flying anywhere close to any magnetic interference is HIGHLY DISCOURAGED. (Please make sure to keep far away from the following: High-Voltage transmission power lines, Emitting base stations, metal objects, etc.)

Calibration is necessary in below cases:

1. Before flying drone for the first time.
2. If 100KM or more away from the last compass calibration location.
3. The drone has been crashed/dropped by accident.
4. The drone keeps swaying / drifting during flight.
5. If the drone has incurred or was subjected to a heavy shaking during transportation.
6. If the RED light stays on, and the motors can't be unlocked.

There are two ways to calibrate the compass, one is to calibrate in the 2 primary planes – horizontal and vertical (simple and fast), and the other, is to calibrate the six surfaces, (of a cube) for higher accuracy.

Two Sided Calibration – (horizontal and vertical planes)

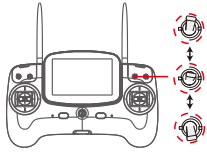
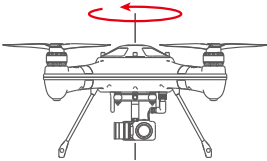
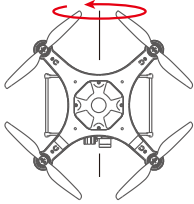
Operation Illustration	Description
	<p>1. Place the drone onto a horizontal surface, power on the controller, and then power on the drone. After the “DI” sound, fast flick the mode switch from GPS-Smart Cruise-ATTI and ATTI-Smart Cruise-GPS, when the yellow light is on, the system enters into compass calibration.</p>
	<p>2. Hold the drone horizontally, rotate counter clockwise until the green LED light turns on.</p>
	<p>3. Swing the drone to a vertical plane, with the nose pointing downward, rotate the drone counter clockwise until the LED changes to a blinking red-green-yellow, indicating the completion of the calibration. If the calibration procedure failed, the RED light will be on for 3 seconds, you will need to redo the calibration. (It may be necessary to do a six-sided calibration if the two-sided calibration will not successfully calibrate, for more information, please refer to the manual.)</p>

Six Surface Calibration (six sides of a cube)

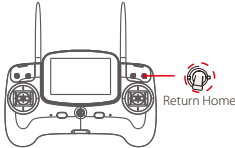
Operation Illustration	Description
	<p>1. Place the drone on a horizontal surface, power on the controller, and then power on the drone. After “DI” sounds, flick the return home switch to Return Home.</p>

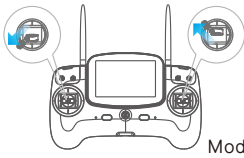

Mode 1

2. **Mode 1:** Pull the left joystick to the lower left corner (45 degrees), the right joystick to the upper left corner (45 degrees), maintain this gesture for 2 seconds, The light changes to a fast blinking red-green-yellow , the drone has entered into the compass calibration mode. We will refer to the face of a clock of positional reference -12 -3 -6 -9.

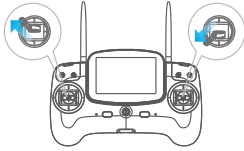

Mode 3

Mode 3: Move the Left joystick to the top left corner (45 °), and the right hand joystick to the lower left corner (45 °), as shown in the diagram, maintain this gesture for 2 seconds, the red - green - yellow light will flash indicating the compass calibration mode and status.

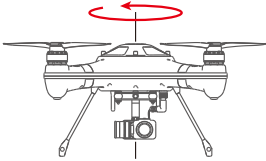

3. In the horizontal plane, rotate the drone in a counter clockwise rotation for 360 degrees.

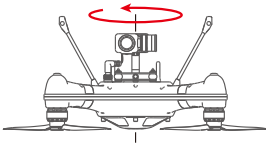

4. Now, invert the drone, and rotate the drone in a counter clockwise rotation for 360 degrees.

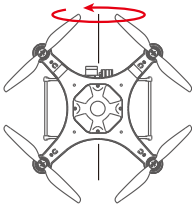

5. Swing the drone vertically, nose up (12midday), and perform a counter clockwise rotation for 360 degrees.

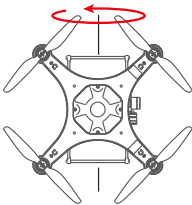

6. Whilst vertical, turn the drone so the nose is to the left (3 o'clock), and perform a counter clockwise rotation for 360 degrees.

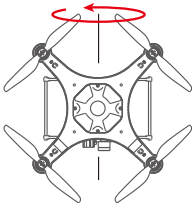

7. Whilst vertical, turn the drone such its nose is pointing down (6 o'clock), and perform a counter clockwise rotation for 360 degrees.

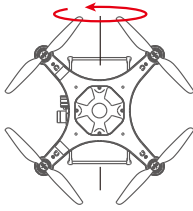

8. Finally, whilst vertical, turn the drone such that it's nose is pointing to the right (9 o'clock) and perform a counter clockwise rotation for 360 degrees.

Now, place the drone on a horizontal surface for about 90 seconds, the fast blinking red-green-yellow LED will change to slow blinking. The calibration is completed.

💡 The standard of judging whether the calibration is successful or not, is whether the drone motors can be unlocked. Switch to Normal from Return Home mode, and try to unlock the motors in ATTI mode.

💡 If the motors cannot be unlocked, it means the calibration was not successful, please relocate to another place and repeat the above calibration procedure.

Starting / Stopping the Motors

Precautions before unlocking the motors:

- 💡 Place the drone in an open area at least 3 meters away from you, or others.
- 💡 Put the Return Home mode switch in the Normal position, and the flight mode switch into either GPS or ATTI mode, and then power on the remote control.
- 💡 Make sure that each part of the drone is connected properly. And the propellers are installed correctly
- 💡 When the drone is powered on, the drone will do a self-check, and when complete, it will issue a "DI" sound.
Note: While the drone is completing its self-check, please keep the drone stationary.
- 💡 If ATTI mode is selected, there is no need to wait, you can unlock the motors and proceed to takeoff and fly immediately, however, in GPS mode, it is necessary to wait until the number of satellites is a minimum of 9, before attempting to unlock the motors.

Unlocking the Motors



Unlocking: Pull both the left and right joysticks simultaneously towards the inner side of the lower side, at an angle of 45 degrees, and maintain this position for 3 seconds, the motors will now be unlocked, and will start rotating.

Stopping (locking) the Motors

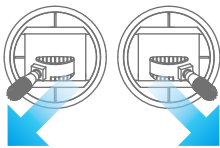

To lock the motors: Pull both the left and the right joysticks outwards to the lower sides at an angle of 45 degrees to stop, and lock the motors.

- ⚠ Take Note: The motors can be stopped for any emergency. Stopping the motors whilst airborne may cause the drone to crash, and should only be carried out in emergencies (for example: there is a risk that the drone may hit people, or crowds), and stopping the motors will minimize any potential damage.
-

Basic Flight Operation

Basic Flight Steps

1. Place the drone on a flat open surface or on the surface of the water.
 2. Power on the remote control, followed by the drone.
 3. Wait for the FPV screen to display the camera's live video, and the OSD data display is normal, and there are more than 9 GPS satellites. The drone enters into a safe flight status, you can unlock the motors and fly.
 4. Push the THROTTLE joystick up slowly, allowing the drone to take off smoothly.
 5. When you need to descend, slowly pull down the throttle lever, whilst flying the drone, allowing the drone to descend, and land on a flat surface, or on the water.
 6. After safely landing, keep the throttle down in its lowest position for at least 5 seconds until the motors have stopped.
 7. First, power down the drone, followed by its remote control.
-

- ⚠ For more use information on flight knowledge, please watch the tutorial videos.
-

Aerial tips and tricks

1. Always check everything prior to flying.
 2. Preferably, try to take photos or videos while flying in GPS mode.
 3. Try to choose clear, less windy weather.
 4. Set up the camera parameters according to your filming requirements, like picture format, exposure etc.
 5. Before your intended flight, familiarize yourself with the environment, this helps for efficient flying and optimum photography.
 6. While flying, apply the minimum of movement on the joysticks, this will allow for smooth video and good quality still pictures.
-

- ⚠ Flight safety awareness is very important for you, the people and the environment around you. Be sure to read the disclaimer, and the safe operating instructions carefully.
-

Frequently Used Parts

This section introduces the more frequently used parts.

Selecting the channel (there are a total of 40 channels)

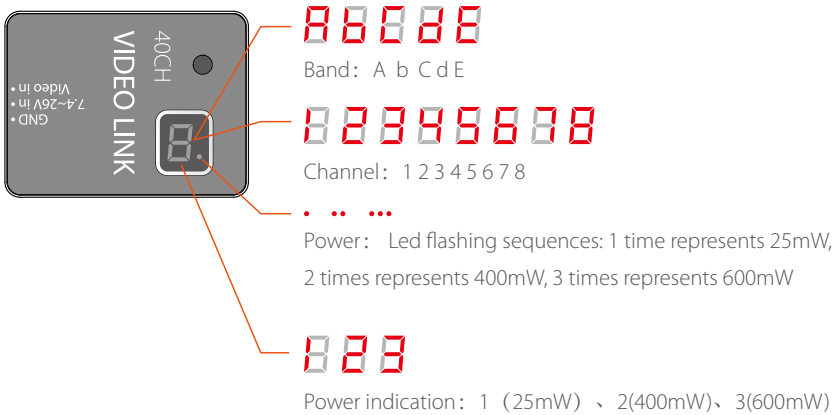

Channel Selection

After powering on the transmitter, it will initially display the currently selected frequency band, followed by the current channel, and, in the lower right corner, a red dot flashing indicating the currently selected transmission power level as described above.

An Example: To set up channel E5:

1. Long press the button for 3 seconds, it initially enters into the band selection, and will automatically scroll between the bands (A, B, C, D, E), When it reaches "E", short press the button to choose E brand and short press again to scroll from E1 to E8, long press for 2 seconds to confirm the channel.

2. To adjust to E5, short press the button 4 times. When the system cycle shows the frequency band E and channel 5, long press the button for 2 seconds, the dot in the lower right corner will flash once to confirm the selection, release the button. On completion, the system will display "E" first, followed by "5", and finally the dot will flash representing the transmission power level.

Power Selection

1. To enter the power-switching mode, long press the button for 5 seconds, the system will then display the currently selected power level, corresponding to the number of slow flashes. If you need to change the power level, press the button to select the desired transmission power level.



2. After selecting the required power level, press the button for 2 seconds, the dot at the lower right corner will flash once, confirming your selection, and then exit from the power selection mode. Release the button, the system will now confirm your selections of the band, channel and power level, firstly showing you the selected band, followed by the selected channel, and finally the transmission power level, represented by the number of flashes of the red dot.

3. Please note: We recommend running at 400mW video power level when operating within an 800 metre radius, this level is a good nominal level and also extends the flying time. If it is required to flying in areas of obstructions and/or exceeding 800m, it may be required to switch to 600mW transmission power.

Payload Release

The patented payload release device is a powerful and versatile accessory to expand the use and applications of the Splash Drone 3. With the help of the payload release, Splash Drone 3 can help fishermen to put the fishing bait far away from the shore. Rescuers use Splash Drone 3 to search for stranded personnel, and deliver vital rescue equipment to them in advance. The maximum 1kg payload, controlled by the remote control, Splash Drone 3 can do much more than, reaching beyond the abilities and efficiency of people.

Installation

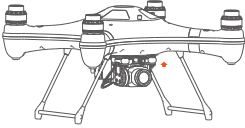
Installation Illustration	Description
	Loosen the bolt at the bottom of the fuselage
	Mount the payload release onto the quick dismounting plate, and fasten the bolt.
	Insert the cable connector plug in the right direction, and lock the waterproof nut.

How to use the payload release system.

1. After the device is installed, power on the remote controller, and the drone.
2. Put the Airdrop switch to the Airdrop position, you can then see the release of the pin.
3. Prepare the goods to be delivered, and put the rope into position in the mechanism. Then put the Airdrop switch to the OFF to close the bolt.
4. Clear to takeoff and get airborne, find and locate the right dropping area with the help of the FPV screen, and drop the goods.

APP Control

How to use the APP

1. Download Swellpro Fly App into your iPhone. Or download the APK from www.swellpro.com for your Android phone.
2. Power on the Bluetooth datalink module, switch on the GPS and Bluetooth on your smartphone. Find the corresponding Bluetooth Link (e.g: UAV-2...) and link it (Note: when the bluetooth is linked, the blue light on the Bluetooth datalink module will stop blinking).
3. Run the "Swellpro Fly" APP, click the Bluetooth icon to link the device (UAV..). When it links, you will see the drone parameters on the screen, e.g battery voltage, GPS coordinates, height, distance, GPS signal etc.

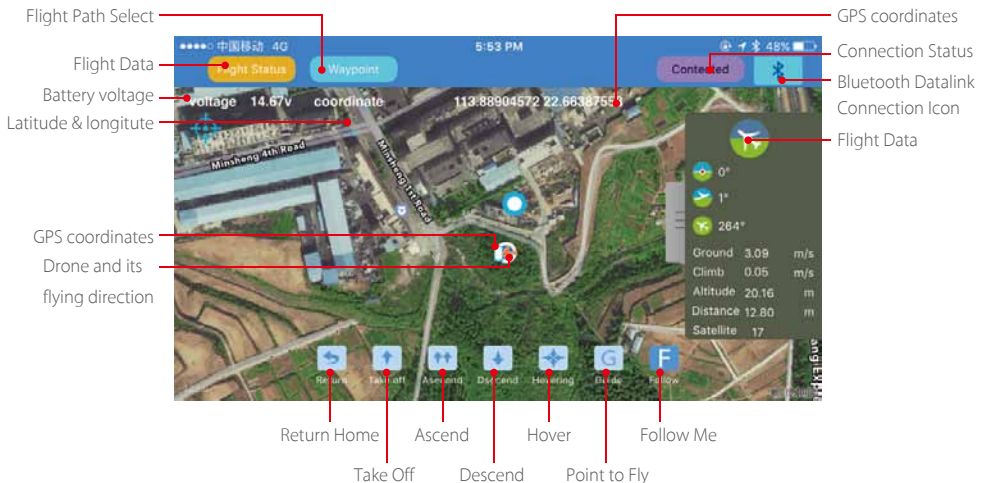
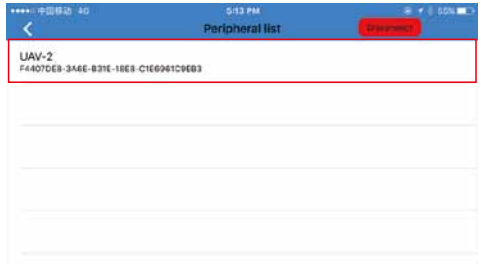

4. Once you have a minimum of 9 GPS satellites, you can unlock the drone and start flying with controller, or use the APP to unlock the motors and start flying.



5. The APP allows you to start flying the drone, land, ascend, hover, return home, flight path setting, follow me and point to fly.

6. Flight path setting:

a). click "+", click the map to set the flight point, you will see all the selected flight points on the bottom of the screen. You can delete them.

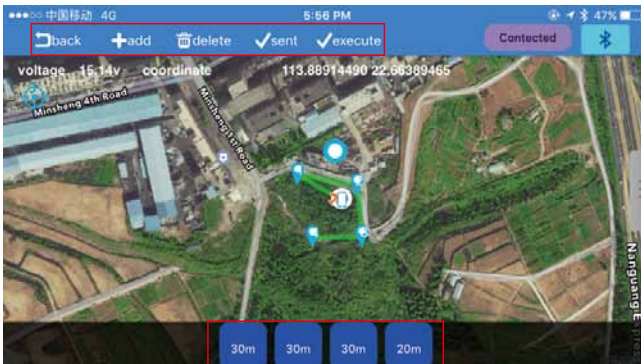

b). Click below the flight point, you can choose the height, hovering time and other options. Save and click "Run", the drone will start flying according to the set path.



7. **Follow Me:** The target (to be followed) should carry the Bluetooth Datalink and the (connected) smart phone, the drone recognizes the GPS coordinates of the smartphone. Press the "Follow Me" button, the drone will then start following.

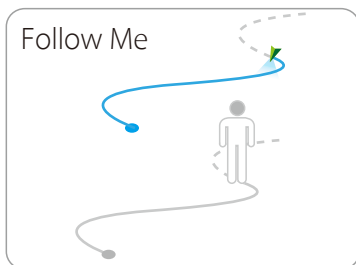

8. **Point-to-Fly:** Click the “Point-to-Fly” button, and then click the target point on the map, the drone will start flying to the point and hover there.

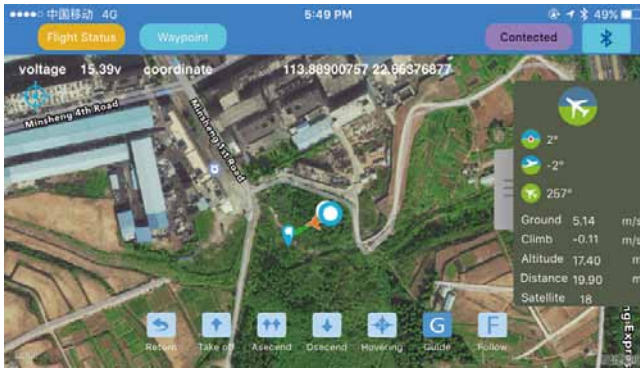

Note:

1. The APP control needs to have a good wireless communication environment, if you see the drone does not respond to your order, it might be subjected to interference, please try again.

2. If the drone continually fails to respond to your APP commands, please use the controller to operate the drone. Just switch the flight mode switch for one single operation, the controller will take over the control of the drone.

3. The Bluetooth data link module is paired with the corresponding module onboard the drone. Normally, it won't link to other drones. When you see many drones or Bluetooth datalink units working in the same place, please make sure you link to the right drone.

Appendix

Specification

Drone

Waterproof Level	Surface Buoyant (short periods up to 600mm)
Drone Weight	2380g (AUTO version)
Axis Diameter	450mm
Max Ascend speed	4m/s
Max descend speed	3m/s
Max flight speed	16m/s
Max Flying altitude	4000meter (above sea level)
Nominal flying wind speeds	a. Typical Maximum = 8m/s (11-16knots)(F4) b. Typical Gusts = 12m/s (22-27Knots) (F6) Peak
Hovering Precision	±0.5meter
Max Flight time (per charge)	16minutes
Max Take off weight	3KG
Positioning System	Dual Satellites - GPS/GLONSS
Flight Controller	Swellpro S3
Waterproof Brushless Motor	#3510/620KV
ESC	40A

Gimbal

Waterproof Rating	IP67
Stabilization System	2 axis – Vertical adjust , Tilt correction
Vertical Controllable Range	Tilt -90°to 0, Vertical -20° to 20°
Angle step precision	±0.02°

Camera

Waterproof Rating	IP67
Image Sensor	1/2.3" CMOS, 1400M
Lens F.O.V	106° at F2.0
ISO range	100 - 1600
Picture Resolution	14M(4320x3240) 10M(3648x2736) 5M(2592x1944)
Video Resolution	APP control: 1920*1080(30/60p) 1280*720 (30/60p) Remote Control: 2880*2160 24p 2560*1440 30p 1920*1080(30/60p) 1280*720(30/60p)
Max video stream	28000Kbps
Picture Format	JPEG RAW J+R
Video Format	MOV MP4
Supports memory card	Class 10 or UHS-1 and above specifications Micro SD card, maximum support 64GB

Battery

Battery Type	4S lipo battery for drone/ 2S lipo battery for controller
Capacity	14.8V 5200mAh (Drone) /7.4V 1800mAh (Controller)
Charging Temperature	-10C°~ 40C°

Remote Control

Weight	660g
Frequency	2405 ~ 2475HMZ
Range	1.0 KM
Receiver Sensitivity(1%PER)	-105dbm
Working Current	160-300mAh
No. of Channels	10

FPV Screen

Frequency	5645 ~ 5965HMZ
Screen Size	5inch
Resolution	800X480Pixels
Brightness	500 cd/m ²

Drone Firmware Upgrade

Please use Swellpro Assistant 3 software to upgrade the drone firmware.

Drone Firmware Upgrade

1. Run the Swellpro Assistant 3 on your windows computer.
2. Connect the drone and computer with the supplied USB cable.

Please Note: Firmware upgrades are only available using a PC based on Windows operating system, and not through an IOS system.

Warranty Information

Please visit the Swellpro website to find out the latest information on:

Swellpro's After-sales service policy:

Swellpro's Maintenance service policy: