

SNAPTAIN

# SP7100

FOLDABLE GPS DRONE

FOR AGES  
**14+**

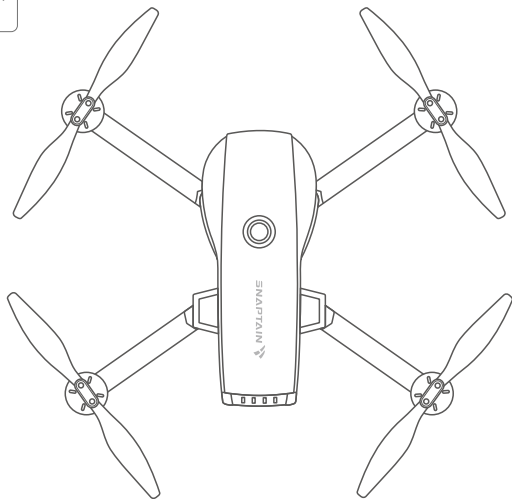

## USER MANUAL

Please read this manual carefully before flying and keep it for future use.

V1.02

# CONTENTS

DISCLAIMER AND SAFETY GUIDELINES .....	01
MAINTENANCE AND CARE .....	03
PRODUCT OVERVIEW .....	05
FLIGHT PREPARATION .....	07
FLIGHT OPERATION GUIDE .....	10
● Remote Operation Guide .....	11
Pair the Remote with the Drone .....	11
Calibrate the Compass .....	12
Calibrate the Gyro .....	13
Search GPS Satellites .....	14
Connect to Your Mobile Device .....	16
Download and Install the APP .....	16
Launch the APP .....	16
Flight Instructions .....	17
Take-off .....	17
Landing .....	18
Flight Directions .....	19
Photo/Video .....	20

Camera Tilt .....	20
Speed Switch .....	21
Headless Mode .....	21
Return-to-Home (RTH) .....	22
Attitude (ATTI) Mode .....	25
Emergency Stop .....	26
● App Operation Guide .....	26
Function Overview of the App .....	26
Settings .....	28
Take-off .....	29
Landing .....	29
Follow Me .....	29
Waypoints .....	30
Point of Interest (POI) .....	32
Photo/Video .....	32
Smart RTH .....	33
<b>TROUBLESHOOTING .....</b>	<b>34</b>
<b>SPECIFICATIONS .....</b>	<b>36</b>

## DISCLAIMER AND SAFETY GUIDELINES

Please read the disclaimer carefully before using this product. By using it, you hereby agree to this disclaimer and signify that you have read them fully.

1. Before flying, please make some practice with a simulator or seek for the instruction from a professional.
2. DO NOT fly above or near obstacles, crowds, open water, public road, high voltage power lines or trees.



3. DO NOT use the drone in severe weather conditions, such as a rainy day or windy day (the wind speed is more than 5.5m/s), snow, hail, lightning, tornadoes, hurricanes, etc.



4. DO NOT fly the drone in the magnetic interference area, radio interference area, and government regulated no-fly zones.



5. The fast rotating motors and propellers are a potential hazard to cause serious damage and injury. A safe distance of 5m must be maintained from the drone at all times while it is operational. Fly with responsibility.



6. Please maintain line-of-sight of your drone at all times after it is powered up. Do not rely on the camera image to control your drone.



7. This product is not a toy and not recommended for users under age 14.



8. All parts must be kept out of the reach of children to avoid CHOKE HAZARD.



9. CAUTION: Dispose of drone and batteries in accordance with local regulations. DO NOT treat it as household waste.



10. Be sure to observe all local regulations, obtain appropriate authorizations and understand risks. Please note it is solely your responsibility to comply with all flight regulations.



SNAPTAIN accepts no liability for damage, injury or any legal responsibility incurred directly or indirectly from the use of this product. The user shall observe safe and lawful practices including, but not limited to, those set forth in these Disclaimer and Safety Guidelines. SNAPTAIN reserves the right to update this user manual.

## MAINTENANCE AND CARE

---

1. Thoroughly check the drone after a crash or a violent impact.
2. Clean off your drone with a dry cloth to prevent any moisture from getting onto the electronics.
3. Do not try to disassemble or repair the product yourself. Please contact SNAPTAIN for more help.
4. Remove the battery from the drone if it will not be used for a long time.
5. Please store and charge the battery in a cool (0~40°C) and dry place. Do not leave the battery in an extremely high-temperature environment that can result in an explosion or the leakage of flammable liquid or gas.
6. Please use the original battery provided. Use an incorrect type of battery may lead to fire hazards.
7. Do not charge the battery if it is hot. Let it cool down first.
8. ONLY use the original USB cable provided. Do not over charge the battery. Unplug the charger once the battery is fully charged.
9. Do not charge the battery next to inflammables, such as bed, carpet, wood floor, etc., or on surfaces that are electrically conductive. Do not leave the battery unattended while charging.
10. Keep the battery away from any sharp objects that could puncture into the battery to avoid risks of explosion and fire.
11. Do not dispose of the battery in fire or a hot oven, cut or mechanically crush the battery, as this may cause explosions.

12. Do not drive a nail in, hit with a hammer, or stamp on the battery. Do not strike the battery in other ways.
13. Do not disassemble or alter the outside structure of the battery.
14. Do not expose the battery to the extremely low air pressure, as this may result in an explosion or the leakage of flammable liquid or gas.
15. Do not store the battery for long periods of time when it's in low battery status. To extend the battery's lifespan, recharge it at least once every three months if not using it for long periods of time.
16. Replace the battery if it's swollen.

# PRODUCT OVERVIEW

## Drone

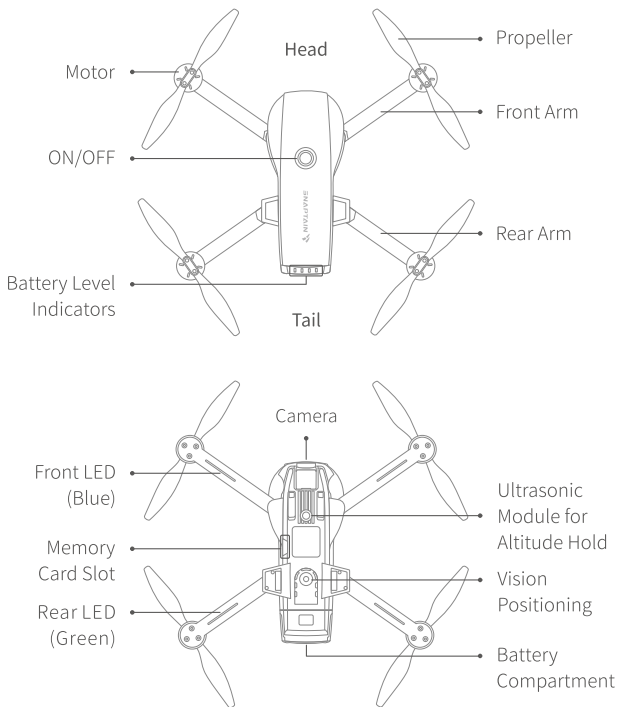

### Notes:

- \* Remove the protective film from the camera.
- \* Please do not manually adjust the camera to avoid damage to it.



## Remote

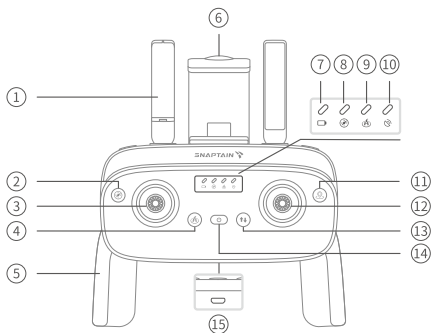

- |                               |                                |
|-------------------------------|--------------------------------|
| ① Antenna                     | ⑧ Headless Mode Indicator      |
| ② Headless Mode (short press) | ⑨ RTH Indicator                |
| Emergency Stop (long press)   | ⑩ GPS Mode Indicator           |
| ③ Left Control Stick          | ⑪ GPS Mode On/Off (long press) |
| ④ Smart RTH (Return-to-Home)  | ⑫ Right Control Stick          |
| ⑤ Handle                      | ⑬ One Key Take-off/Landing     |
| ⑥ Phone Clamp                 | ⑭ ON/OFF                       |
| ⑦ Remote Power Indicator      | ⑮ Charging Port                |

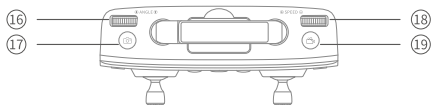

- |               |                |
|---------------|----------------|
| ⑬ Camera Tilt | ⑮ Speed Switch |
| ⑭ Photo       | ⑯ Video        |

# FLIGHT PREPARATION

- 1 Unfold the rear arm, then the front arm.

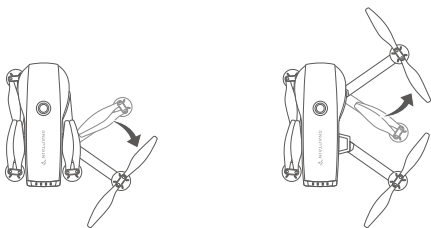

- 2 Charge the drone battery.

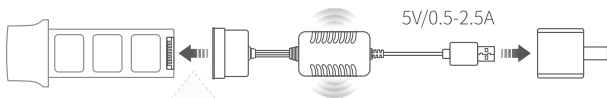

Charging: Red LED

Fully Charged: Green LED

## Notes

- \* Please use the original battery and USB cable provided.
- \* It's not recommended that you charge the battery from the USB port of PC.
- \* Flight time may be reduced when flying in low-temperature environments.

3 Install the battery into the drone after it's fully charged.

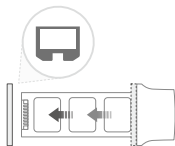

Remove the protective foam first.

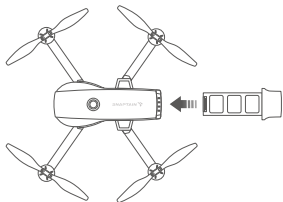

\* How to take out the battery?

Turn over the drone, press the release button down and pull out the battery.



4 Insert a memory card (not included) into the drone. (Optional)

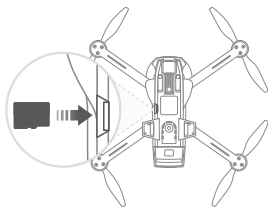

- \* Support up to 64GB.
- \* Memory card of FAT32/exFAT format is required.

## 5 Charge the remote.

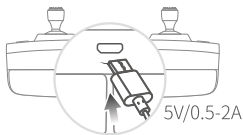

Charging: Flash green  
Fully Charged: Solid green

\* The remote's **Power Indicator** keeps flashing when its battery is low.

## 6 Unfold the Handle and Antenna.

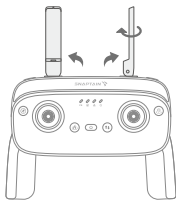
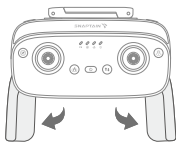

## 7 Pull out the Phone Clamp to mount your mobile device.

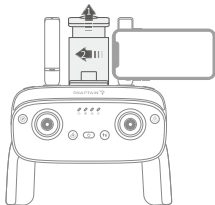
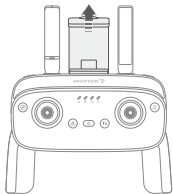

## 8 Replace the propeller when it's needed. (Optional)

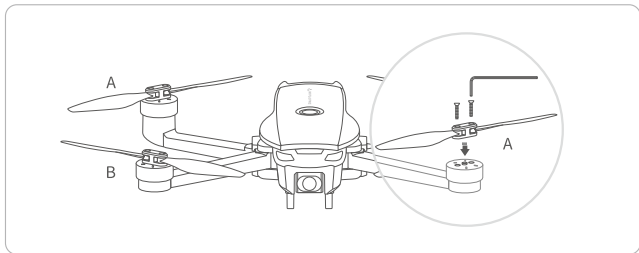

- \* Keep the motor in place.
- \* Use the wrench to loosen the screw, then remove the propeller.
- \* Fit the spare propeller into the drone. Ensure the mark (A/B) on the back of the propeller is the same as the mark on the motor.
- \* Tighten the screw.

## FLIGHT OPERATION GUIDE

---

### IMPORTANT

- \* Make sure you power on the drone first, then the remote in each flight.
- \* Do repeat the **Compass Calibration** each time the drone is restarted.
- \* For all flight functions and modes, the operator and tail of the drone must be aligned.
- \* We recommend flying the drone in the open air and within the control range.

## • Remote Operation Guide

### Pair the Remote with the Drone

#### Step 1:

Turn on the drone by long pressing the **ON/OFF** button for 3s until the **Battery Level Indicators** light up. The LEDs on the drone start flashing when the drone is powered on. Place the drone on a flat surface with the head forward.

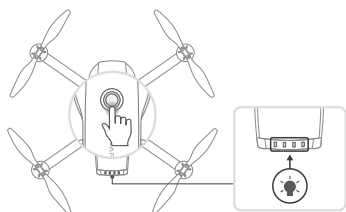

#### 💡 Tips:

- 1 Long press the **ON/OFF** button to turn off the drone.
- 2 The drone will automatically turn off if no operation within 10 minutes.

#### Step 2:

Turn on the remote by long pressing the **ON/OFF** button for 2s until the four indicators on it light up.

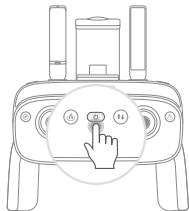

### 💡 Tips:

- 1 Long press the **ON/OFF** button to turn off the remote.
- 2 The remote will automatically turn off if no operation within 30 minutes.

### Step 3:

Wait for the remote to automatically pair with the drone. Pairing is complete when the remote beeps once, and the four indicators on it turn solid on.

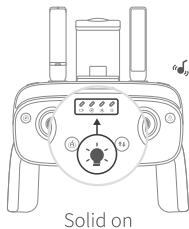

## Calibrate the Compass

The drone has prepared for compass calibration after pairing; the LEDs on the arm of the drone are flashing quickly.

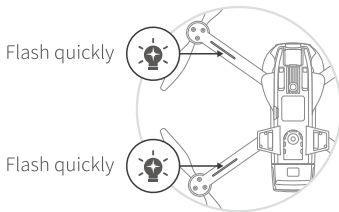

**Step 1:**

Hold the drone horizontally and make a full rotation at least twice until the remote beeps once, which indicates a successful horizontal calibration. The LEDs on the arm of the drone turn flashing slowly.

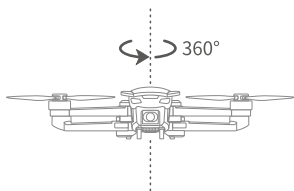

Flash slowly

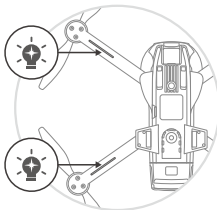

Flash slowly

**Step 2:**

Hold the drone vertically with its head facing up, and make a full rotation at least twice until the remote beeps once, which indicates a successful vertical calibration. The front LEDs turn solid on.

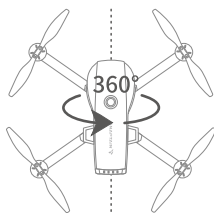

Solid on

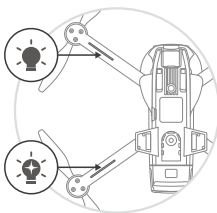

Flash slowly

**Calibrate the Gyro**

Place the drone on a flat surface after finishing compass calibration. Push both control sticks to lower left at 45° to start calibrating the gyro, the LEDs on the arm of the drone start flashing quickly. Calibration is complete when the remote beeps once. The drone's front LEDs turn solid on, and the rear LEDs flash slowly.



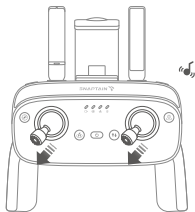

Solid on

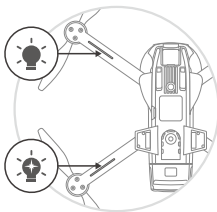

Flash slowly

## Search GPS Satellites

Wait for the drone to search satellites. When you hear a long beep from the remote and its **GPS Mode Indicator** starts flashing, the drone has found enough satellites and is ready to take off in **GPS Mode**. The drone's LEDs will all turn solid on.

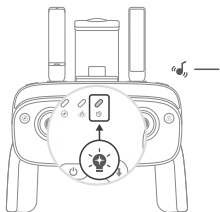

Flash

Solid on

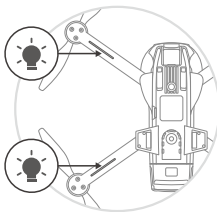

Solid on

Ready to take off in **GPS Mode**

**GPS Mode Indicator:**

Flash: GPS Mode available

Solid on: GPS Mode unavailable

The drone is set to **GPS Mode** by default. In this mode, the drone utilizes the GPS module to locate itself and make a precise hovering flight.

#### Notes

- \* **GPS Mode** only works when the GPS signal is strong. Please fly the drone outdoors.
- \* We strongly recommend this mode for beginners.

The rear LEDs keep flashing slowly if the drone can't find enough satellites. Please go to another place to fly the drone if you want it to take off in **GPS Mode**.

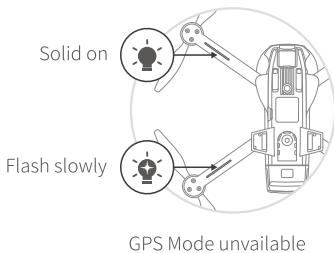

If you still want the drone to take off when **GPS Mode** is unavailable, you can switch it to **Attitude (ATTI) Mode** (refer to [Page 25](#)).

## Connect to Your Mobile Device

### Download and Install the APP

Download and install **Snaptain Epic** into your mobile device on **App Store™**/**Google Play™** or by scanning the QR code below.



For Android 4.3 and later



For iOS 8.0 and later

#### Note

\* Google Play™ is a trademark of Google Inc., and App Store™ is a trademark of Apple Inc.

### Launch the APP

#### Step 1:

Go to the Wifi settings of your mobile device and connect to the drone's Wifi **SNAPTAIN-SP7100-xxxxxx**.

#### Step 2:

Open **Snaptain Epic** and tap **Start** to enter the operation interface.

## Notes

- \* If you can't see the live map, please disconnect to the drone's Wifi, then turn on cellular data and location service on your mobile device to preload the map. Next, turn off cellular data and reconnect to the drone's Wifi, then launch the app.
- \* The drone's Wifi has no Internet access. To prevent your mobile device from automatically switching to another network, we recommend to turn off the cellular data when connecting to the drone's Wifi.
- \* If the Wifi **SNAPTAIN-SP7100-xxxxxx** is not listed in your Wifi list or the app does not show the preview image, please restart the drone, then repeat the pairing and calibration procedures.
- \* Make sure Wifi **SNAPTAIN-SP7100-xxxxxx** is only connected to one mobile device.

## Flight Instructions

### Take-off

#### Option 1:

Simultaneously move the **Left Control Stick** to lower left at 45° and the **Right Control Stick** to lower right at 45° until the four rotor blades start rotating, then press the  button to take off.

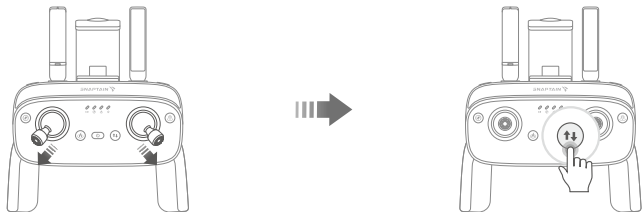

## Option 2:

Simultaneously move the **Left Control Stick** to lower left at 45° and the **Right Control Stick** to lower right at 45° until the four rotor blades start rotating, then slowly push the **Left Control Stick** forward to take off.

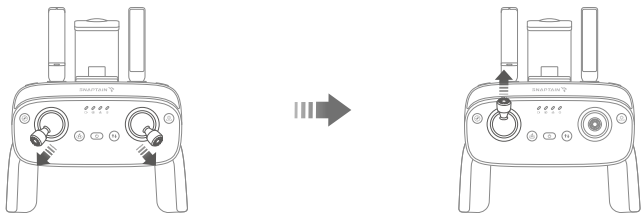

### 💡 Tip:

If you don't want the drone to take off after unlocking it, simultaneously move the **Left Control Stick** to lower left at 45° and the **Right Control Stick** to lower right at 45° again (🌀 🌀) to make the propellers stop rotating.

## Landing

### Option 1:

Press the 📶 button to land the drone.

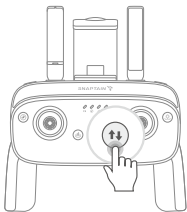

## Option 2:

Slowly pull the **Left Control Stick** backward to land the drone until the propellers stop rotating.

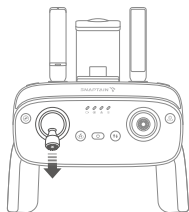

## Flight Directions

### Left Control Stick

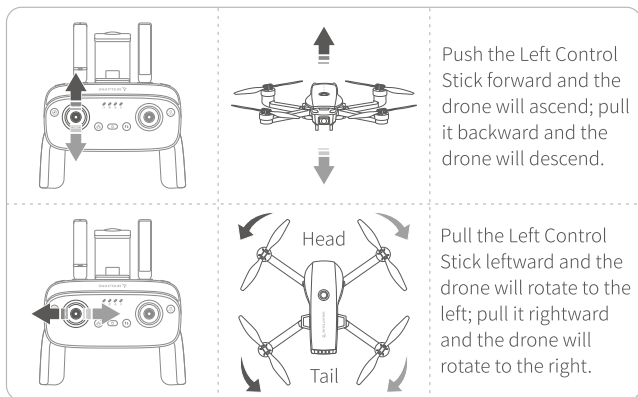

## Right Control Stick

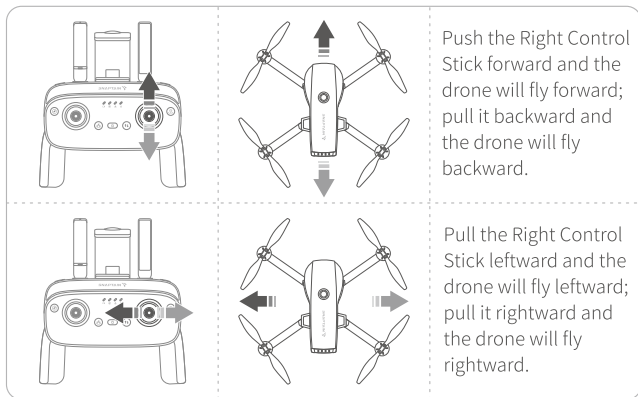

## Photo/Video

Press the  button to take a photo.

Press the  button to start recording a video. Press it again to stop and save the video to your mobile device and memory card.

## Camera Tilt

Push  rightward to make the tilt the camera upward; push it leftward to tilt the camera downward.

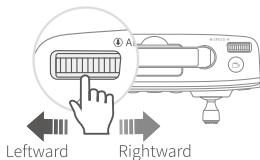

## Speed Switch

The speed of the drone is set to **Low** speed by default.

Push **SPEED** leftward to switch to **High** speed and the remote beeps twice.

Push it rightward to switch to **Low** speed and the remote beeps once.

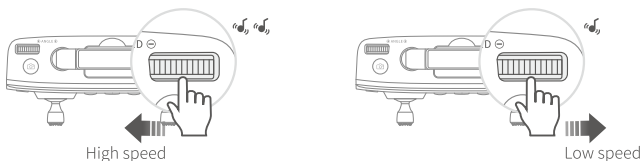

## Headless Mode

Press the **Headless Mode** button to activate **Headless Mode**.

In this mode, the drone will fly following the direction of the **Right Control Stick** regardless of the position of your drone's head or the tail.

Press the same button again to cancel this mode.

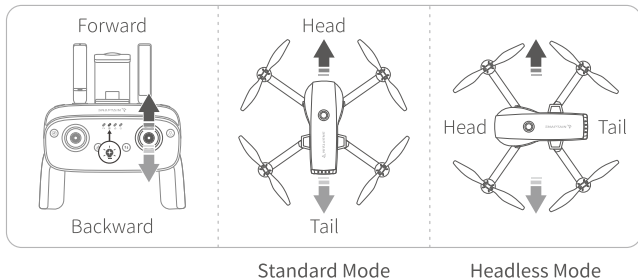





### Headless Mode Indicator:

Flash: Headless Mode on

Solid on: Headless Mode off

## Return-to-Home (RTH)

The **Return-to-Home (RTH)** function brings the drone back to the last recorded **Home Point** where the drone took off last time. RTH only works when the GPS signal is strong enough and the compass functions normally.

### Smart RTH

Press the  button on the remote to initiate **Smart RTH**.

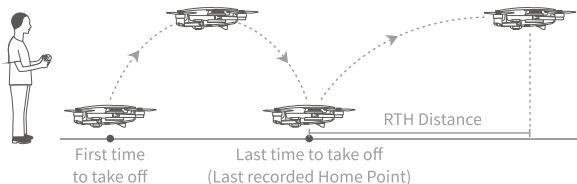

#### 1. Current Flight Altitude < 15m

The drone will first ascend to the altitude of 15 meters, then fly back to **Home Point** and descend to land.

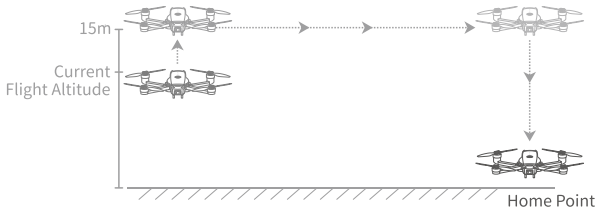

## 2. Current Flight Altitude $\geq 15\text{m}$

The drone will directly fly back to **Home Point** at its current flight altitude and descend to land.

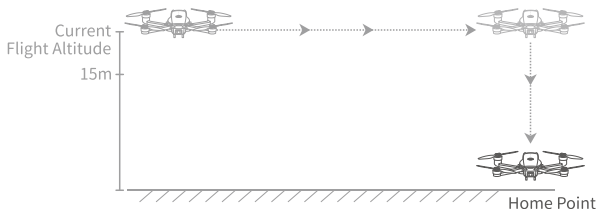

Press the  button again to cancel RTH and regain control of the drone.

### Failsafe RTH

Failsafe RTH will be activated automatically when the drone disconnects with the remote. The drone will fly back to the last recorded **Home Point** under the control of the flight system itself.

The process of **Failsafe RTH** is the same as **Smart RTH**.

If the connection between the remote and the drone is re-established, the pilot can cancel RTH by pressing the  button and regain control of the drone. If no operation is performed, the RTH process will continue.

When the remote disconnects with the drone and the **GPS Mode** is not available, the drone will descend from its current altitude to land.

### Low Battery RTH

The drone will trigger **Low Battery RTH** when its battery is low. It will fly back to where RTH distance and altitude is 15m and hover, then RTH will be canceled. The drone can't fly beyond 30m anymore no matter how the pilot operates.



Drone battery status shows 2 bars on the app.



The remote keeps beeping.

The drone will trigger **Critical Low Battery RTH** when its battery is critical low.

### 1. RTH Distance $\leq 5\text{m}$

The drone will descend to land from its current altitude.

### 2. RTH Distance $> 5\text{m}$ , RTH Altitude $< 15\text{m}$

The drone will first ascend to the altitude of 15m, then fly back to **Home Point** and descend to land.

### 3. RTH Distance $> 5\text{m}$ , RTH Altitude $\geq 15\text{m}$

The drone will fly back to **Home Point** and descend to land.



Drone battery status shows 1 bar on the app.



The remote keeps beeping.

### Notes

- \* The drone can't automatically avoid obstacles during RTH. Move the control stick to adjust the drone's position if needed.

- \* During **RTH**, the remote keeps beeping and its **RTH Indicator** flashing.

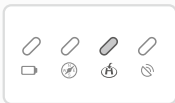

#### RTH Indicator:

Flash: RTH enabled

Solid on: RTH disabled

## Attitude (ATTI) Mode

In **ATTI Mode**, the drone will maintain a specific flight altitude, but it will drift around in the wind.

Long press the  button for 2s until the remote beeps twice to manually activate **ATTI Mode**.

Long press the  button again until the remote beeps once to cancel **ATTI Mode**.

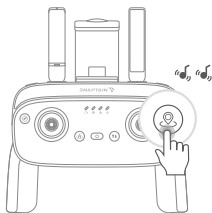

### Notes

- \* During the outdoor flight, the drone will automatically switch to **ATTI Mode** if it flies to a place where the GPS signal is weak.
- \* In **ATTI Mode**, functions based on **GPS Mode**, including **RTH**, **Follow Me**, **Waypoints**, and **POI**, can't be activated.
- \* We recommend **ATTI Mode** only when the pilot has proficient skills in operating the drone.

## Emergency Stop

Press and hold  for 6s, and the drone will stop in the air and fall.

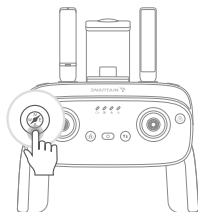

### Note

\* It's NOT recommended to use this function during normal flight for landing, which may cause serious damage to your drone.

## • App Operation Guide

### Function Overview of the App

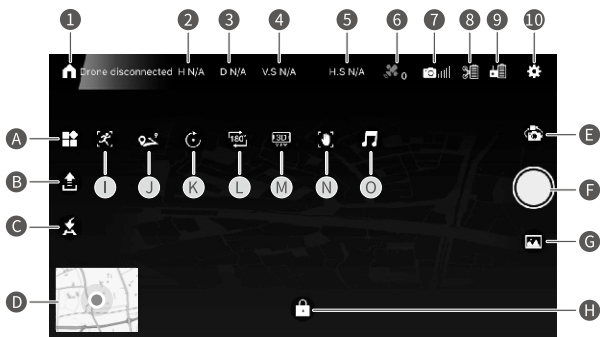

- 1 Home
- 2 Flight Altitude
- 3 Flight Distance
- 4 Ascent/Descent Speed
- 5 Horizontal Flight Speed
- A More Functions
- B One Key Take-off/Landing
- C Return-to-Home (RTH)
- D Live Map
- E Photo/Video Mode
- F Shutter
- G Media Gallery
- H Unlock
- 6 GPS Signal
- 7 Wifi Signal
- 8 Drone Battery Status
- 9 Remote Battery Status
- 10 Settings
- I Follow Me
- J Waypoints
- K Point of Interest (POI)
- L Flip Image
- M VR Mode
- N Gestures for Photo/Video
- O Music

► **GPS Signal:**

Check the number of GPS satellites.

► **Wifi Signal:**

Check the wifi signal strength. We recommend flying the drone back when the wifi signal is weak (1 bar).

► **Drone Battery Status:**

Check the battery status of the drone.

► **Remote Battery Status:**

Check the battery status of the remote.

► **Flip Image:**

Tap  to flip the image 180°.

### ► VR Mode:

Tap  to activate VR mode (VR device is not provided).

### ► Media Gallery:

Tap to check the photos and videos saved.

## Settings

Tap  to start setting up your drone.

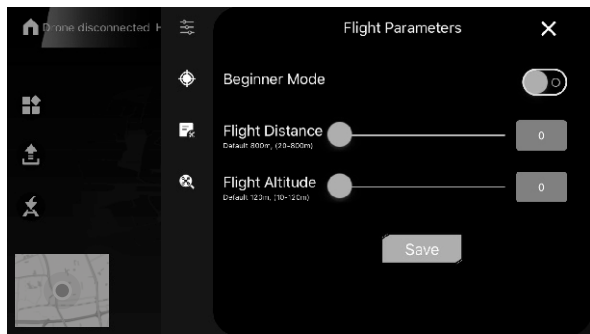

Tap  to set the maximum flight distance and flight altitude. Beginner mode with preset flight parameters is recommended for beginners.

Tap  to calibrate the drone.

Tap  to check the flight logs.

Tap  to check the last recorded location of the drone.

## Take-off

### Step 1:

Tap  to unlock the drone and the four rotor blades start rotating.

### Step 2:

Tap  and slide rightward on the pop-up window to take off.

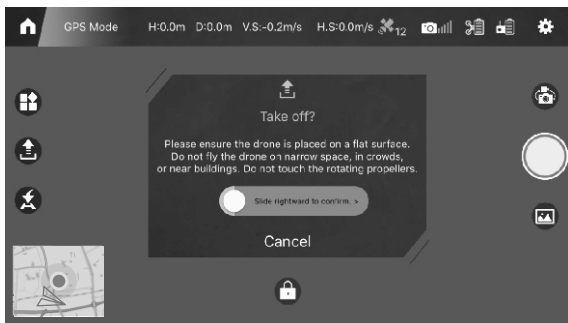

## Landing

Tap  and slide rightward on the pop-up window to land the drone.

## Follow Me

When **Follow Me** is enabled during the flight, the drone will fly follow your mobile device with its camera lens pointing at it.

Tap  and slide rightward on the pop-up window to enable **Follow Me**.



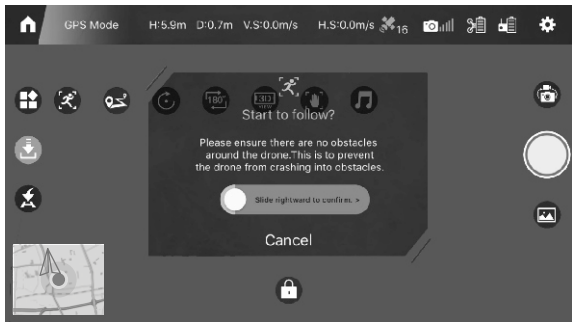

Tap  again to cancel this mode and regain control of the drone.

#### Notes

- \* The function **Follow Me** may have deviation due to the GPS signal. Please maintain a safe distance between you and the drone when enabling this function.
- \* Activate this function only when there is no obstacle around you in case of unexpected accidents.
- \* This function can't be activated when the battery of the drone is low.



## Waypoints

**Waypoints** function allows you to define an exact flying route on a map during the flight.

### Step 1:

Tap  to enter the interface of waypoints.

**Step 2:**

Tap some desired waypoints on the map. Tap  to delete a waypoint or  to delete all waypoints if you want to reset.

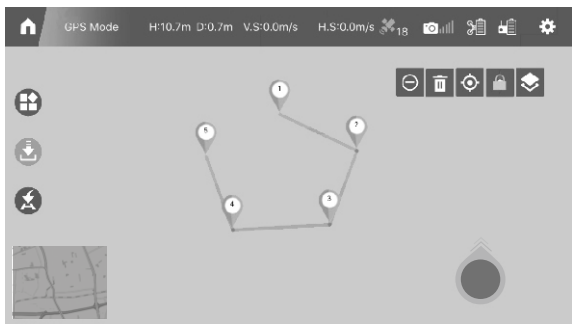
**Step 3:**

Tap  to upload waypoints.

**Step 4:**

Slide rightward on the pop-up window to start to fly following the route of waypoints.

**Step 5:**

Tap  again to cancel this mode and regain control of the drone.

**Notes**

- \* Ensure there are no obstacles around the route.
- \* This function can't be activated when the battery of the drone is low.

## Point of Interest (POI)

When POI is enabled during the flight, the drone will circle around the current point of the drone while keeping that point centered in the frame.

Ensure there are no obstacles around the POI radius.

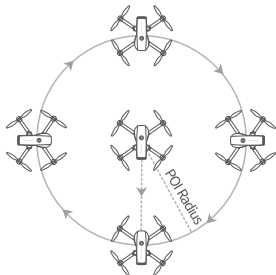

### Step 1:

Tap  and set the POI radius.

### Step 2:

Slide rightward on the pop-up window to activate POI.

### Step 3:

Tap  again to cancel this mode and regain control of the drone.

### Note

\* This function can't be activated when the battery of the drone is low.

## Photo/Video



Tap  to take a photo.

Tap  to switch to video mode. Tap  to start recording a video, and tap it again to stop and save the video to your memory card and mobile device.

## Tips:

- 1 Tap  to set your desired BGM for video recording.
- 2 Go to **Media Gallery** to check the photo and videos saved. Select the photos or videos preferred to share with others.

## Gestures for Photo/Video:

Tap  to activate this function. Within 3m under a light-filled environment, please stand in front of the camera and make a  gesture to take a photo, a  gesture to start/stop recording a video.

## Smart RTH

Tap  to activate **Smart RTH** during the flight and have the drone returned to the last recorded **Home Point**. Slide rightward on the pop-up window to start RTH.

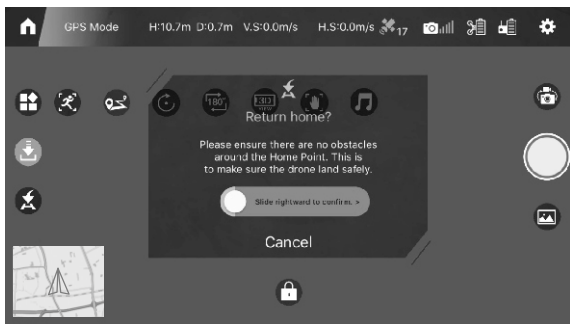

Tap  again to cancel this mode and regain control of the drone.

# TROUBLESHOOTING

---

## 1. The four LEDs of the drone keep flashing extremely quickly after powering on.

- \* The drone starts self-checking after powering on. Place the drone on a flat surface with the head forward.

## 2. The drone can't take off after I power on it.

- \* Do calibrate the compass each time you power on the drone. The drone can't take off without compass calibration.

## 3. The drone can't take off indoors after I calibrate it.

- \* The drone is set to **GPS Mode** by default. Please switch to **ATTI Mode** if you would like to fly the drone indoors or somewhere GPS signal is weak. In **ATTI Mode**, the drone can't use GPS positioning; please be cautious with operating to avoid losing your drone.

## 4. Why can't I connect to the drone's wifi?

- \* Ensure only ONE device is connecting to the drone's wifi.
- \* Please restart the drone, then repeat the pairing and calibration procedures.

## 5. Why can't I see the map after launching the app?

- \* Ensure you've installed a map app on your mobile device.
- \* The drone's wifi has no Internet access. Please disconnect to it and turn on cellular data and location service on your mobile device to preload the map, then turn off your cellular data and connect to the drone's wifi again.

## 6. Why does my drone fly sideways?

- \* Ensure **GPS Mode** is **ON**, and the GPS signal is strong.
- \* The drone's gyro is abnormal. Please land the drone, place it on a flat surface, and do the gyro calibration.

7. The FOLLOW ME function doesn't work.

\* Ensure you've turned on the location service on your mobile device, and the drone is flying in **GPS Mode**.

8. How can I fly the drone back when I can't tell the head or tail of the drone?

\* Ensure you've turned on **GPS Mode**, press the  button to trigger RTH function, then the drone will automatically fly back home.

9. How to cancel Failsafe RTH?

\* Press the  button to cancel **Failsafe RTH** when the remote receives the signal from the drone again.

10. The drone can only fly within a short distance when its battery is low.

\* The drone can't fly beyond 30 meters when its battery is low.

# SPECIFICATIONS

Drone		
Operating Temperature	32°F to 104°F (0°C to 40°C)	
Frequency Range	Model SP7100: 5150-5250 MHz	
Transmit Power (EIRP)	Model SP7100: 5 GHz < 18 dBm	
Camera		
Controllable Range	Tilt: -90° to 0°	
Remote		
Frequency Range	Model SP7100: 2405-2475 MHz	
Transmit Power (EIRP)	Model SP7100: 2.4 GHz < 18 dBm	
USB Cable		
	For Drone Battery	For Remote
Input	5V $\overline{\text{---}}$ 0.5-2.5A	5V $\overline{\text{---}}$ 0.5-2A
Output	7.6V $\overline{\text{---}}$ 2A (MAX)	5V $\overline{\text{---}}$ 0.3A
Rated Power	10W (MAX)	1.5W

## FCC Caution:

Any Changes or modifications not expressly approved by the party responsible for compliance could void the user's authority to operate the equipment.

This device complies with part 15 of the FCC Rules. Operation is subject to the following two conditions:

(1) This device may not cause harmful interference, and (2) this device must accept any interference received, including interference that may cause undesired operation.

Note: This equipment has been tested and found to comply with the limits for a Class B digital device, pursuant to part 15 of the FCC Rules. These limits are designed to provide reasonable protection against harmful interference in a residential installation. This equipment generates, uses and can radiate radio frequency energy and, if not installed and used in accordance with the instructions, may cause harmful interference to radio communications. However, there is no guarantee that interference will not occur in a particular installation. If this equipment does cause harmful interference to radio or television reception, which can be determined by turning the equipment off and on, the user is encouraged to try to correct the interference by one or more of the following measures:

- Reorient or relocate the receiving antenna.
- Increase the separation between the equipment and receiver.
- Connect the equipment into an outlet on a circuit different from that to which the receiver is connected.
- Consult the dealer or an experienced radio/TV technician for help.

For Remote:

This equipment complies with FCC radiation exposure limits set forth for an uncontrolled environment.

For R/C QUADCOPTER:

This equipment complies with FCC radiation exposure limits set forth for an uncontrolled environment .

This equipment should be installed and operated with minimum distance 20cm between the radiator& your body.

This transmitter must not be co-located or operating in conjunction with any other antenna or transmitter.

## ISED Warning:

This device complies with Industry Canada licence-exempt RSS standard(s). Operation is subject to the following two conditions:

- (1) this device may not cause interference, and
- (2) this device must accept any interference, including interference that may cause undesired operation of the device.

Le présent appareil est conforme aux CNR d'Industrie Canada applicables aux appareils radioexempts de licence. L'exploitation est autorisée aux deux conditions suivantes :

- (1) l'appareil ne doit pas produire de brouillage, et
- (2) l'utilisateur de l'appareil doit accepter tout brouillage radioélectrique subi, même si le brouillage est susceptible d'en compromettre le fonctionnement.



For R/C QUADCOPTER:

The device is compliance with RF exposure guidelines, users can obtain Canadian information on RF exposure and compliance. The minimum distance from body to use the device is 20cm.

Operation of this device in the band 5150-5250 MHz is restricted to indoor use only.

L'appareil est conforme aux directives d'exposition aux RF, les utilisateurs peuvent obtenir des informations canadiennes sur l'exposition aux RF et la conformité. La distance minimale du corps pour utiliser l'appareil est de 20 cm.

Le fonctionnement de cet appareil dans la bande 5150-5250 MHz est limité à une utilisation en intérieur uniquement.

For Remote:

The device is compliance with RF exposure guidelines, users can obtain Canadian information on RF exposure and compliance.

Le présent appareil est conforme Après examen de ce matériel aux conformité ou aux limites d'intensité de champ RF, les utilisateurs peuvent sur l'exposition aux radiofréquences et la conformité and compliance d'acquérir les informations correspondantes.

This transmitter must not be co-located or operating in conjunction with any other antenna or transmitter. Cet émetteur ne doit pas être colocalisé ou fonctionner en conjonction avec une autre antenne ou un autre émetteur.

## CAUTION

RISK OF EXPLOSION IF BATTERY IS REPLACED BY AN INCORRECT TYPE  
DISPOSE OF USED BATTERIES ACCORDING TO THE INSTRUCTIONS



The symbol indicates DC voltage



RECYCLING

This product bears the selective sorting symbol for Waste electrical and electronic equipment (WEEE).

This means that this product must be handled pursuant to European directive 2012/19/EU in order to be recycled or dismantled to minimize its impact on the environment. User has the choice to give his product to a competent recycling organization or to the retailer when he buys a new electrical or electronic equipment.

This product can be used across EU member states.

The device is low power device, it can meet the requirement of the RF exposure.

EU Compliance Statement: Shenzhen VanTop Technology & Innovation Co., Ltd. hereby declares that this device is in compliance with the essential requirements and other relevant provisions of the Directive 2014/53/EU.

A copy of the EU Declaration of Conformity is available online at <https://doc.vantop.com/>.



AT	BE	CY	CZ	DK	EE	FI
FR	DE	EL	HU	IE	IT	LV
LT	LU	MT	NL	PL	PT	SK
SI	ES	SE	UK	BG	RO	HR

In all EU member states, operation of 5150-5350 MHz is restricted to indoor use only.



BATTERY MUST BE RECYCLED OR DISPOSED OF PROPERLY

## Manufacturer

Shenzhen VanTop Technology & Innovation Co., Ltd.

Manufacturer address:

502, 5th Flr. BLDG 4, MinQi Technology Park, No. 65 Lishan Road, Taoyuan Street, Nanshan District, Shenzhen, China

EC	REP
----	-----

C&E Connection E-Commerce (DE) GmbH  
 Zum Linnegraben 20, 65933, Frankfurt am Main, Germany  
[Info@ce-connection.de](mailto:Info@ce-connection.de)

# SNAPTAIN SUPPORT



US [support@snaptain.com](mailto:support@snaptain.com)

CA [support@snaptain.com](mailto:support@snaptain.com)

UK [support.uk@snaptain.com](mailto:support.uk@snaptain.com)



[www.snaptain.com](http://www.snaptain.com)



[@snaptainofficial](https://www.facebook.com/snaptainofficial)



[@snaptain\\_official](https://www.instagram.com/snaptain_official)