

D85

User Manual



Farther. Faster. Clearer.
(This camera works with 5G WIFI only.
Please make sure that your device
supports 5G WIFI.)

GPS



TapFly



Follow me



Point of interest



GPS Positioning



One key to Return



Brushless motor
(2204 1500KV)



Independent ESC
(stuck and high-temperature protection)



2.4GHz two-way
communication
(weak signal alarm, low voltage alarm)

Important statement and safety guidelines

Thank you for purchasing Potensic product. Please read this manual carefully before use and retain it for future reference.

It should be retained for future reference.

Important statement

- This aircraft is not a toy, but hobby grade model. It should be assembled and operated properly. Pilot must operate this aircraft in safe way. Improper operation may cause injury or property damage.
- This aircraft is applicable for pilots aged 14+ who are with skilled flying experience.
- Users are in full charge of proper operating this aircraft. Manufacturer and dealers disclaim any responsibility for damages caused by misuse.
- Keep the small accessories away from kids to avoid accident.

Flight safety guidelines

Hobby grade radio control aircraft is somewhat considered to be the item with the most potential danger.

Users should firmly uphold the principle of "safety comes first". Never fly the aircraft near airports, above crowds or in zones storing dangerous goods and realize operator's responsibility towards accidents caused by improper operations.

• Stay away from obstacles, crowds, power lines, trees or waters

Always choose a wide open area for every flight, well away from people and property. Never fly directly over people or animals. Please don't fly in such bad weather conditions as high temperature, snow, strong wind (\geq level 5), rain or fog. Maintain a 7ft (2m) distance from the aircraft when taking off and landing.

• Keep the aircraft in dry environment

The aircraft is composed by sophisticated electronic components and mechanical parts. To avoid damages on the mechanical and electronic components, please keep the aircraft in dry environment and use clean cloth to wipe the surface and keep it clean.

• Practice flying together with skillful pilot

Beginners are suggested to practice flying together with skillful pilot's guidance. Do not fly alone.

● Bear proper operation and safe flight guidelines in mind

Please take a careful look at the manuals before flights for important information of product functions and operation tips, and learn how to use the accessory, safe flight always comes first. Stay informed of and abide strictly by relevant local laws and regulations. Keep away from any non-flight zones and respect other people's privacy.

● Safe flying

Please make sure you are in good shape mentally before every flight. Fly the aircraft as per your flying experience. Never fly under influence of alcohol or drugs. Keep the remote controller at least 20 cm away from your body when flying the aircraft.

● Keep distance from a flying aircraft

Never use your hands to touch a flying aircraft under any circumstance. Don't approach and touch a landed aircraft before its propellers are completely locked.

● Keep away from heat source

The aircraft is made of metal, fiber, plastic, electronic component and other material. Please keep it away from the heat source to avoid deformation or even damage caused by sun exposure and high temperature.

● Environmental protection requirements

To protect our blue planet, please recycle the aircraft as per local laws and regulations.

Product profile

Product configuration

Package includes

Aircraft X1	Camera mount X1	High landing gear X4
Propeller changing tool X1	Remote controller X1	Screwdriver X1
Extra Propellers A/B X2	Charging converter X1	Balance charger X1
Power adaptor X1	Battery X1	Mobile phone holder X1
Camera X1		

Technical parameter of the aircraft

Diagonal: 310mm	Overall height: 150mm	Battery: 7.4V 2800mAh
Gross weight: about 610g (with undercarriage, battery, camera and high landing gear)		
Brushless motor: 2204 1500KV	Maximum flying time: about 19 minutes	

Product assemble

How to attach and detach the propellers

● Attach the propellers:

Install propeller A and propeller B on the corresponding motor shaft and fix the rotor propellers tightly by rotating them as per the “lock” direction showed on the propellers (indicated as Pic. 1).

● Detach the propellers:

Fix the brushless motor by rotor propellers changing tool and then rotate and remove the propellers as per the “unlock” direction showed on the propellers (indicated as Pic. 2).

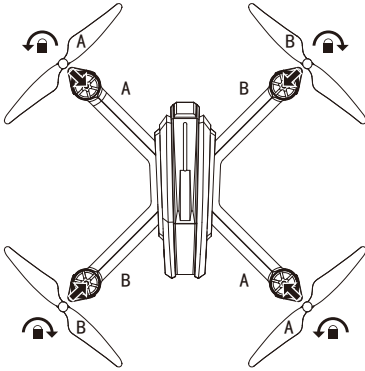

Pic. 1

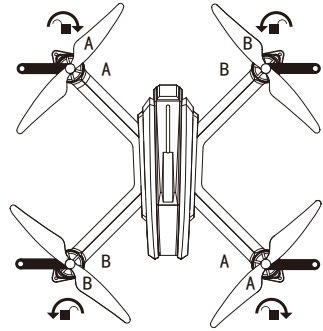

Pic. 2



- Please make sure that the clockwise and the counter-clockwise propellers are installed on the correct motors, because the aircraft will not fly normally for wrong propellers installation.
- Be careful when installing the propellers, as they are a little sharp.
- Please use MJX propellers for this aircraft.
- Extra propellers can be ordered additionally.

High landing gear installation

Insert the high landing gear plug into the socket locating at the bottom of the aircraft, align the 2 screws positions and fix the high landing gear by screwing clockwise.

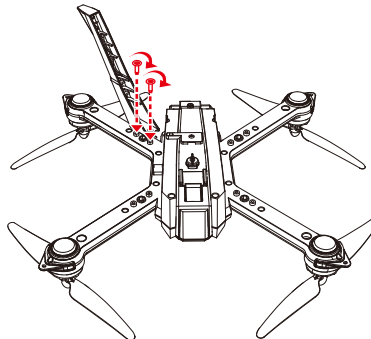

Battery installation

Slide the battery into the battery compartment at the rear of the aircraft by pushing with appropriate force, the aircraft will make beep sounds with LED lights flashing. Please make sure that the battery is installed firmly before flying.

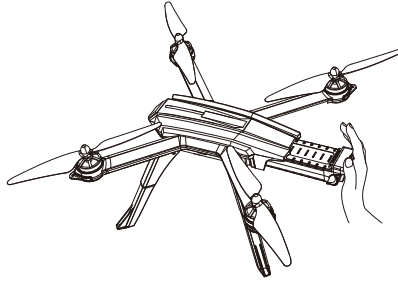

Attention: The battery should be installed firmly, failure to do so may affect the flight safety of your aircraft. The aircraft may crash due to power-cut during the flight.

How to remove the battery

- Step 1. Put your thumb and middle finger on the designated position (indicated as Pic.1);
 - Step 2. Press the elastic buckle at the rear of the battery with your index finger, and pull backward with appropriate force, then the battery will be removed (indicated as Pic. 2-3).
- To avoid slipping, please keep your finger and your aircraft dry and clean.

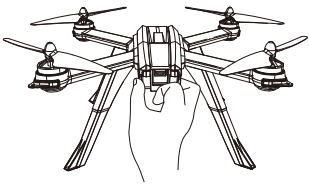

Pic.1

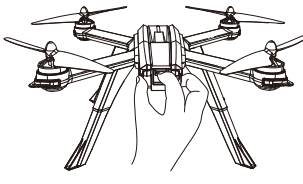

Pic.2

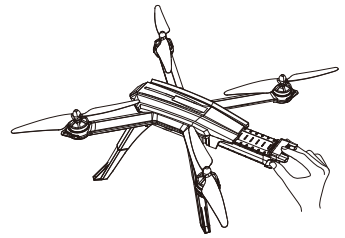

Pic.3

How to charge the battery of aircraft

How to charge the battery with charging device A:

- Step 1. Make sure that the power adaptor is connected with the power outlet (indicated as Pic. 1);
- Step 2. Connect the balance charger to the power adaptor (indicated as Pic. 2);
- Step 3. Insert the white plug of the charging converter face up into the socket of the balance charger (indicated as Pic. 3);
- Step 4. Slide the charging converter onto the battery from the middle position and insert the pins into the battery plug to start charging (indicated as Pic. 4).

Full charging time takes about 7 hours.

- When charging is proceeding, the green light keeps flashing and the red light keeps solid on;
- When charging is finished, both of the green light and red light keep solid on;
- If the battery and charging converter is not connected with the balance charger, but the balance charger is connected with the power adaptor, the red light keeps solid on and the green light is off;
- Once there is any malfunction, the red light will be solid on and the green light will keep flashing rapidly.

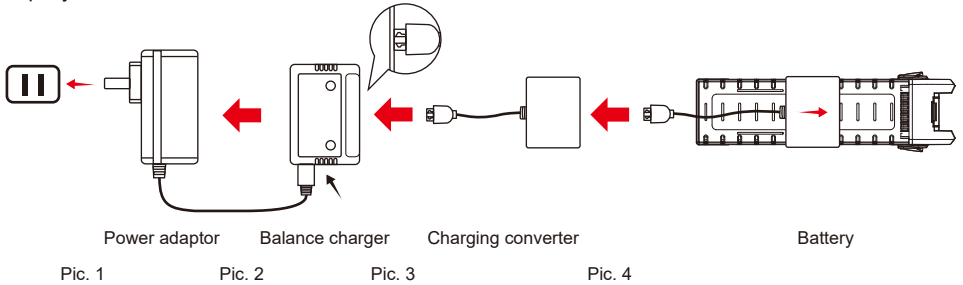

Warm tips:



- The battery plug should be connected correctly with face up (but not upside down) when plug into the balance charger; Failure to do so will result in battery cannot charge or charger damaged.
- We recommend using 5V-2A adaptor for charging.

How to charge the battery with charging device B:

- Step 1: Make sure that the power adaptor is connected with the power outlet (indicated as Pic. 1);
- Step 2: Connect the balance charger to the power adaptor by plug-in the USB cable accordingly (indicated as Pic. 2);
- Step 3: Insert the white plug of the charging converter face up into the socket of the balance charger (indicated as Pic. 3);
- Step 4: Slide the charging converter onto the battery from the middle position and insert the pins into the battery plug to start charging (indicated as Pic. 4).

Full charging time takes about 7 hours.

- When charging is proceeding, the green light keeps flashing and the red light keeps solid on;
- When charging is finished, both of the green light and red light keep solid on;
- If the battery and charging converter is not connected with the balance charger, but the balance charger is connected with the power adaptor, the red light keeps solid on and the green light is off;
- Once there is any malfunction, the red light will be solid on and the green light will keep flashing rapidly.

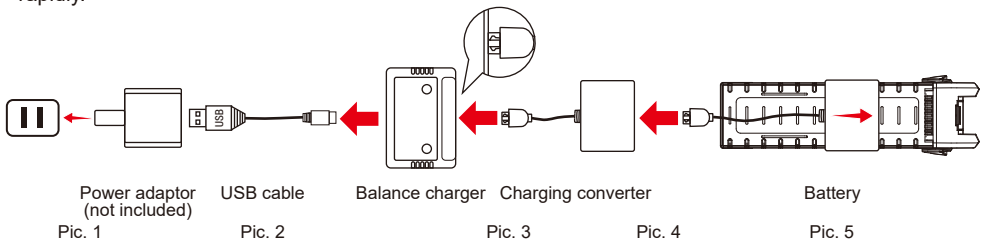



Warm tips:



- The battery plug should be connected correctly with face up (but not upside down) when plug into the balance charger; Failure to do so will result in battery cannot charge or charger damaged.
- We recommend using 5V 1-2A adaptor for charging.
- It's not suggested to charge by computer.



- Need adult supervision when this aircraft is being played by children.
- Only batteries of the same or equivalent type as recommended are to be used.
- Insert batteries with correct polarity.
- Rechargeable batteries are to be removed from the aircraft before being charged.
- Rechargeable batteries are only to be charged under adult supervision.
- Exhausted batteries are to be removed from the aircraft.
- The supply terminals are not to be short-circuited.
- The charging line to be used with the product should be regularly examined for potential hazard, such as damage to the cable or cord, plug, enclosure of other parts and that in the event of such damage, the product must not be used until that damage had been properly removed.

Camera & Camera mount installation

Mounted on Potensic original 5G WIFI camera and install "Potensic-M2" APP on mobile device, your aircraft will be capable of flying in the intelligent flight modes: Follow Me, Point of Interest and Waypoint flight.

Step 1. Insert the TF card(not included) into the card slot at the left side of the camera (Pic. 1);

Step 2. Take out the camera mount (Pic 2);

Step 3. Release the locked buckle of the camera mount; put the EVA pad at the bottom of camera mount; then install the camera with the lens facing up (Pic. 3-4);

Step 4. Lock the buckle of the camera mount after the camera is installed firmly (Pic. 5);

Step 5. Attach the camera mount (with camera facing up) to the aircraft by slide-in firmly; then lock the buckle at the bottom of the battery compartment (Pic. 6-7);

Step 6. Insert the "7" shaped plug of the USB cable into the socket at the left side of the camera (Pic. 8);

Step 7. Insert the other plug of the USB cable into the socket locating at the bottom of the aircraft (Pic. 9).

- Warm Tips: There are 2 pcs of EVA pad included. One is thin and the other one is thick. Please check your camera's dimension and choose proper EVA pad before installing your camera.

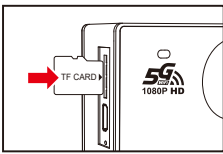

Pic. 1

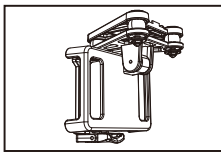

Pic. 2

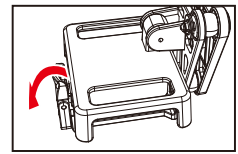

Pic. 3

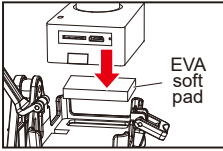

Pic. 4

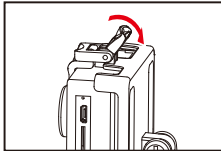

Pic. 5

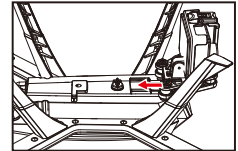

Pic. 6

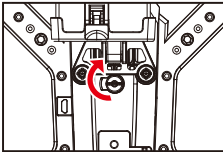

Pic. 7

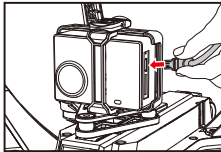

Pic. 8

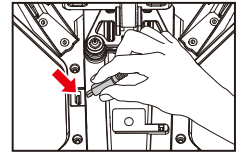

Pic. 9

Major parts of the aircraft

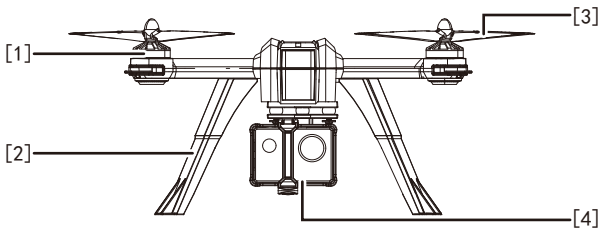

- [1] Brushless motor
- [2] High landing gear
- [3] Propeller
- [4] Camera/Camera mount

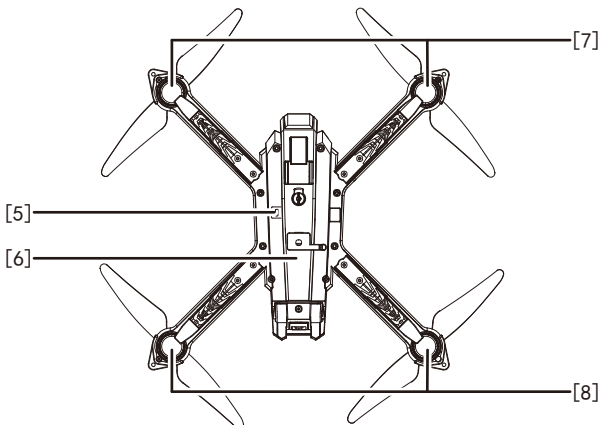

- [5] USB aerial camera port
- [6] Battery compartment
- [7] Front light
- [8] Rear light

Major parts of the remote controller

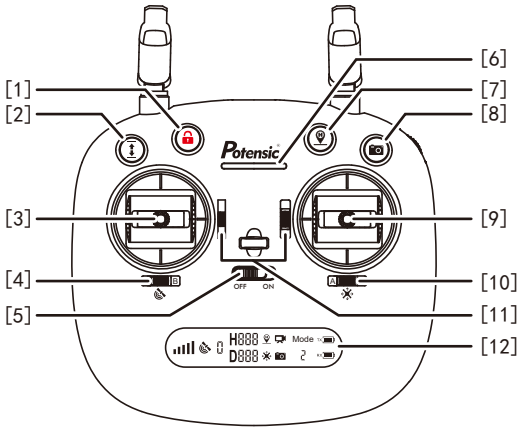

- [1] One key to take off / land
- [2] One key to take off / land
- [3] Left stick
- [4] Gesture/ GPS mode switch
- [5] Power switch
- [6] Power indicator
- [7] One key to return
- [8] Photo/shooting
- [9] Right stick
- [10] Headless mode switch
- [11] Null button
- [12] LCD screen

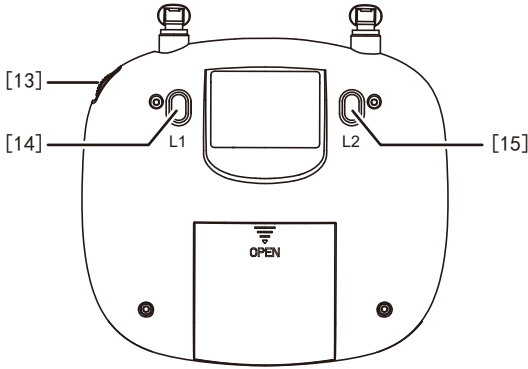

- [13] Null button
- [14] Null button
- [15] Null button

LCD screen

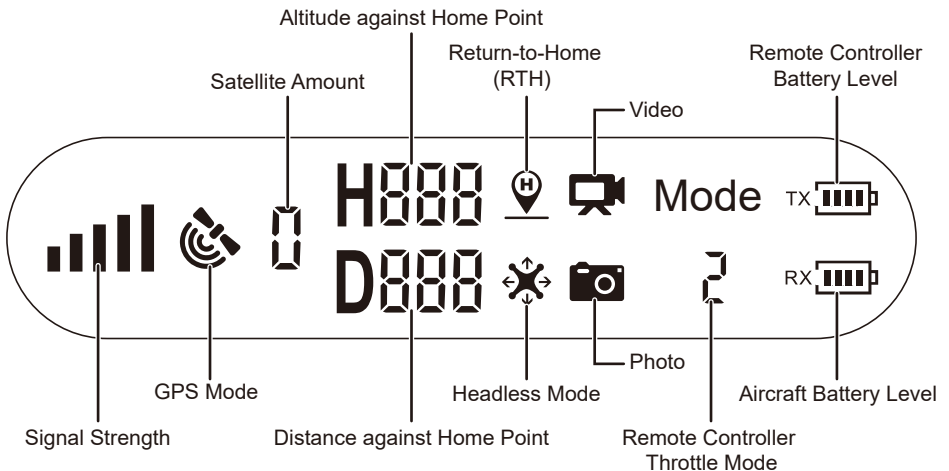

How to install the battery of remote controller

Open the battery cover of the transmitter, insert 4*AA batteries following the polarity indicators (Picture below, battery is not included)and then close it.

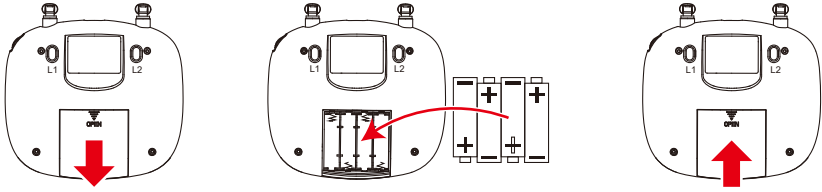

- Insert batteries with correct polarity.
- Non rechargeable batteries are not to be charged; the transmitter need 4*AA batteries for work.
- Do not mix old and new batteries.
- Do not mix alkaline, standard (carbon-zinc), or rechargeable (nickel-cadmium) batteries.
- Rechargeable batteries are to be removed from the aircraft before being charged.
- Rechargeable batteries are only to be charged under adult supervision.
- Exhausted batteries are to be removed from the aircraft.
- The supply terminals are not to be short-circuited.

How to connect the signal of the aircraft with the remote controller

Step 1: Keep pressing the red button “” and turn on the remote controller (indicated as Pic. 1).

Please release it when the remote beeps and make sure that the indicator light on it flashes quickly. It means the remote controller is under signal connection status.

Step 2: Power on the aircraft. The aircraft will make beep sounds with front and rear lights flashing and will automatically link to the remote controller. Once the remote controller sends out a long beep sound and the indicator light of the remote controller turns from flashing to solid on and the signal icon “” is shown on the LCD screen, it means that signal connection is succeeded.

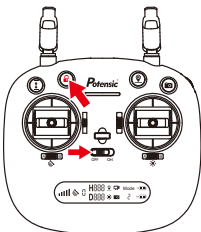

Pic. 1

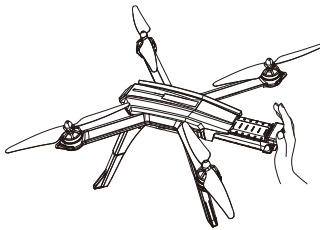

Pic. 2

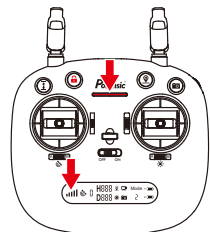

Pic. 3



- Signal connection is done once for all if the remote controller is not linked to other aircraft.
- Set the connection one by one to avoid signal connection error.

Throttle mode switch

Left hand throttle and right hand throttle are available for option at the remote controller. User can choose different control stick mode as per operation habit. There are 2 stick modes that could be found as below:

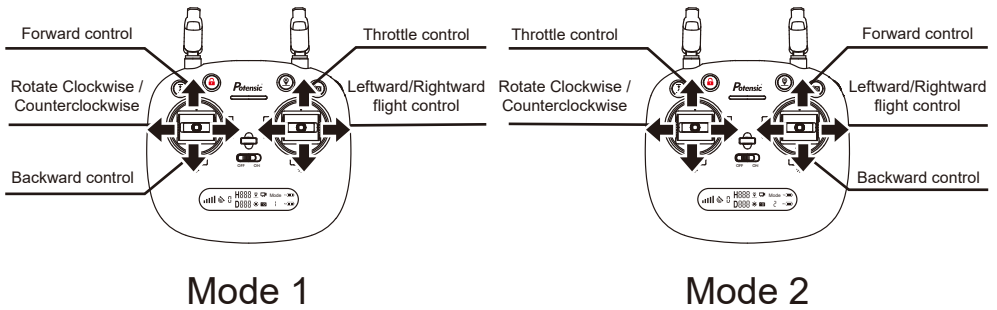

How to change throttle mode

Step 1. Keep pressing the red button and turn on the remote controller at the same time, the remote controller is under signal connection status (indicated as pic.1);

Step 2. Keep pressing the RTH button “” for 3 seconds to choose the throttle control mode (indicated as pic.2). The throttle control mode will change according to each press. The mode number is shown on the LCD screen. The throttle control mode is set at mode 2 by default.

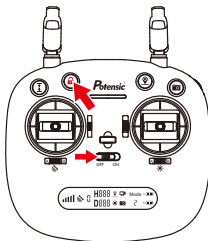

Pic. 1

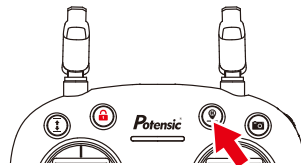

Pic. 2



Attention: To change the stick mode of the remote controller, please make sure that the remote controller is under signal connection status (the indicator light keep flashing). If not, the red stick mode could not be changed.

Remote controller control stick calibration

- Step 1. Keep pressing the red locking button and turn on the remote controller (indicated as pic.1) at the same time;
- Step 2. Press the calibration button for 3 seconds, the remote controller will make 3 beep sounds and the indicator light of the remote controller turns from flashing quickly to slowly. Then maximum rotate both of the left and right control stick to any direction for 2 circles (indicated as pic.2);
- Step 3. Then, again, press the calibration button for 3 seconds. The remote controller will send out 3 beep sounds and the indicator light of the remote controller turns from flashing slowly to quickly, which means that the control stick calibration is completed (indicated as pic.3).

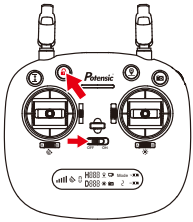

Pic. 1

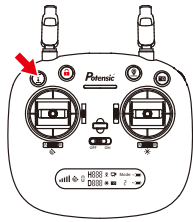

Pic. 2

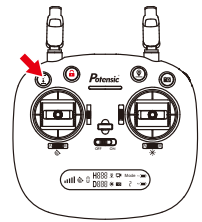

Pic. 3



Warm tips: All remote controllers have been calibrated when manufacturing.

Remote controller calibration is requested only if pilots find that the remote controller control sticks are not working normally.

Attention: Please do not power on your aircraft when calibrate the control stick for the remote controller.

Remote controller status indicator

No.	Remote controller status	Description
1	Indicator lights flash quickly.	The remote controller is under signal connection status.
2	Indicator lights flash slowly with steady beep...beep sound and the battery legend "RX" on LCD screen flashing.	The remote controller is in low voltage status. Please change a full charged battery.
3	Battery legend "RX" on LCD screen is as shown, with steady beep...beep...beep sound.	Battery is running out "RX"; the aircraft will return when the altitude is over 100m or the distance is over 300m.
4	Battery legend "RX" on LCD screen is as shown, with steady long beep sound.	Battery is low "RX"; the aircraft will return when the altitude is over 15m or the distance is over 15m; if either the flying altitude or flying distance is less than 15m, the aircraft will land to the spot.
5	Signal strength on LCD screen is less than two grids or no displaying; and the remote controller makes steady beep...beep...beep sound.	1.The distance between aircraft and remote controller is so long that the signal is weak. 2.The battery of drone is removed after it connects to the remote controller.

Aircraft status indicator

No.	Indicator status	Meanings
1	Front and rear lights flash yellow rapidly.	Aircraft 2.4GHz disconnected.
2	Front and rear lights flash red, green and yellow alternatively.	Aircraft is in initialization detection status.
3	Front lights glow solid red, rear lights glow solid yellow.	No GPS signal, aircraft is in gesture mode.
4	Front light glows solid red, rear light glows solid green.	Good GPS signal, aircraft is preparing for GPS mode.
5	Front and rear lights flash green rapidly.	Aircraft is in gyroscope calibration status.
6	Front and rear lights flash yellow alternatively.	Aircraft is in compass horizontal calibration.
7	Front and rear lights flash green alternatively.	Aircraft is in compass vertical calibration.
8	Front light glows solid red, rear light flashes red slowly.	Aircraft is nearly low voltage, 1/4 battery level left.
9	Front light glows solid red, rear light flashes red rapidly.	Aircraft is in low voltage, only 1/6 voltage left.
10	Front and rear lights flash once, stop for 1.5 second.	Something wrong with the gyroscope.
11	Front and rear lights flash twice, stop for 1.5 second.	Something wrong with the barometer.
12	Front and rear lights flash three times, stop for 1.5 second.	Something wrong with the compass.
13	Front and rear lights flash fourth times, stop for 1.5 second.	Something wrong with the GPS module.

Aircraft initialization detection

After signal connection, the aircraft enters into initialization detection procedure with front and rear lights flashing red, green and yellow alternatively. Make sure that the aircraft is set on a flat and still surface for the initialization detection. The aircraft initialization detection takes about 8 seconds. Once the remote controller sends out "Di Di" sounds and the aircraft front and rear lights flash yellow alternatively, initialization detection is completed.

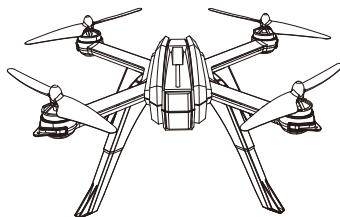

Attention: Make sure that the aircraft is set on a flat and still surface for the initialization detection.

Aircraft compass calibration

Attention:

1. Compass calibration should be performed after successful aircraft initialization detection.
2. Aircraft compass calibration should be done for every flight. That is to say, if changing new battery or the battery is reinstalled, compass calibration should be done again.

Two steps of compass calibration:

Step 1: Horizontal calibration

After successful aircraft initialization detection, the aircraft front and rear lights flash yellow alternatively. Hold the aircraft horizontally and rotate it 360 degrees along the central axis for about 3 circles. The aircraft front and rear light will change from flashing yellow alternatively to flashing green alternatively when horizontal calibration is completed.

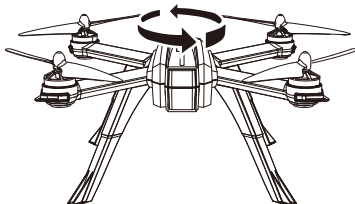

Step 2: Vertical calibration

Hold the aircraft with head up, and rotate it 360 degrees along the central axis for about 3 circles until the front and rear lights of the aircraft change from flashing to solid on, the compass calibration is successful.

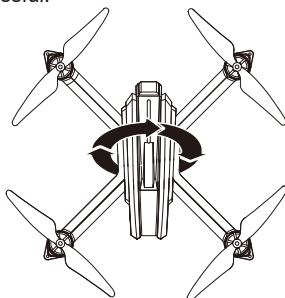

Attention: To fly at GPS mode, please choose an open and wide space for the flight, and make sure that the satellite amount is over 7.



- Please do not calibrate the compass in strong magnetic area, such as magnetic field, parking place or construction areas with underground reinforcement.
- Please do not carry magnetic materials with you (such as keys, cell phones, etc) when calibrating compass.
- Please keep away from big metal when calibrating compass.

Gyroscope calibration

After the aircraft and the remote controller are banded, set the aircraft on flat ground and follow the indication photo as below to calibrate the gyro. Once the aircraft front lights turn from flashing to solid on, it means that the gyro calibration is succeeded.

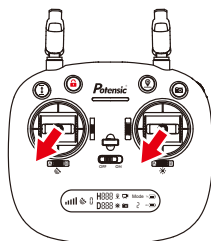
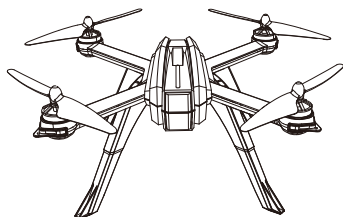

- The gyroscope calibration has been done by factory default. Gyroscope calibration is no need to be performed unless the aircraft can not exit the aircraft initialization detection procedure while the aircraft initialization detection is finished.
- Please make sure to set the aircraft on horizontal surface when performing calibration, failure to do this will affect the flight.

How to lock and unlock the aircraft

Unlock the aircraft:

There are 2 ways to unlock the aircraft that you can find it below:

- Method 1: Short-press the red button “” (indicated as Pic. 1). The motors rotate and the aircraft is unlocked.
- Method 2: Push the left stick to lower right corner and the right stick to the lower left corner at the same time (indicated as Pic. 2) to unlock the aircraft.

Lock the aircraft:

There are 2 ways to lock the aircraft that you can find it as below:

- Method 1: Long-press the red button “” (indicated as Pic. 1) for 3 seconds, the motors will stop rotating immediately and the aircraft is locked.
- Method 2: After the aircraft lands on the ground, pull down the throttle stick to the bottom position and keep for 3 seconds, the motors will stop rotating and the aircraft is locked.

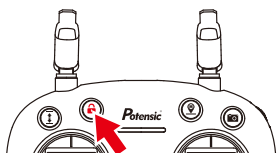

Pic. 1



Pic. 2



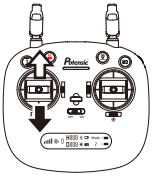
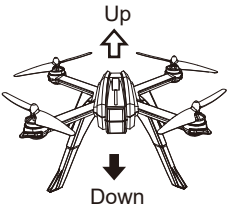
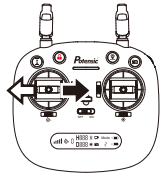
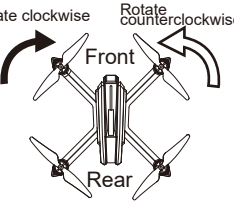
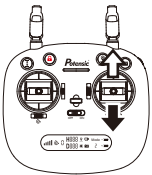
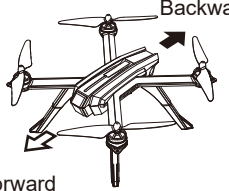
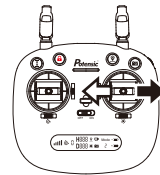
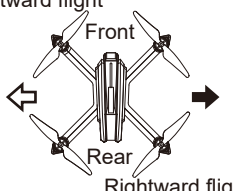

Warm tips: Please do not lock the aircraft by pressing the “” button directly during the flight, or the aircraft will be crashed.

Operate the aircraft

Remote controller	Aircraft	Remote controller	Aircraft
			
			

Flight mode

One-key takeoff/landing

- After the aircraft unlocked, short-press the “” button (indicated as below), the aircraft will automatically takeoff and hover at 1.5m altitude.
- When the aircraft is flying, short-press the “” button (indicated as below), the aircraft will automatically land on the ground.

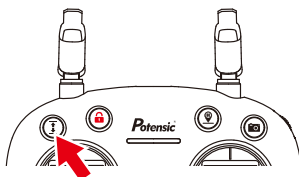

Gesture mode

Slide the button to position “A” (indicated as below), the aircraft is in Gesture mode that GPS is not used for positioning, and the aircraft only uses the barometer to maintain altitude. The aircraft will not fly with precise positioning and hovering. Gesture mode requests pilot with good skill.

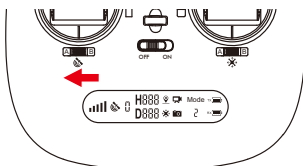

GPS mode

Slide the button to position “B” (indicated as below), the aircraft is in GPS mode and can precisely position and hover by the assistance of the GPS module.

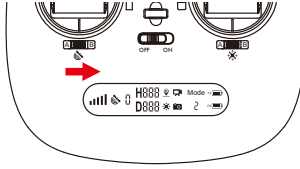

Headless mode

Slide the Headless mode switch button to position “B” (indicated as below); the aircraft enters into headless mode. When the aircraft is in headless mode, you're required to position the aircraft in such a way that its front is your front before the aircraft takes off. Then, when you take off the aircraft with the aircraft pointing to the front, you can give up worrying about orientation during flight.

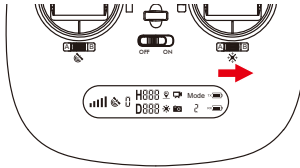

Return-To-Home (RTH)

The Return-to-Home(RTH) procedure brings the aircraft back to the last recorded Home Point. There are 3 types of RTH procedures: smart RTH, failsafe RTH and low battery RTH. The following sections describe them in detail.

	GPS	Description
Home Point		The Home Point is the location at which the aircraft takes off. A strong GPS Signal must be presented for the aircraft to record the Home Point.

Smart RTH

If the GPS signal is available (more than 7 satellites is presented) and the Home Point is recorded previously, press this button, the aircraft will fly back to the Home Point. During the smart RTH, you can use the remote controller to guide the aircraft around obstacles. You can press the RTH button again to exit RTH procedure and regain control of the aircraft.

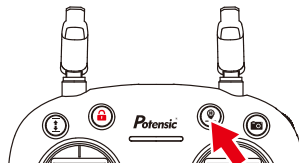

Failsafe RTH

If the GPS signal is available (more than 7 satellites is presented) and the Home Point is recorded previously. Failsafe RTH will be triggered if the remote controller signal is lost for more than 6 seconds, the flight-control system will control the aircraft automatically and the aircraft will fly back to the last recorded Home Point. You can regain control of the aircraft by press the RTH button if the remote controller signal is recovered.



- During the Failsafe RTH procedure, the aircraft can not avoid obstacles.
- The aircraft cannot Return-to-Home if the GPS signal is weak (satellite amount is less than 7).
- If there is no GPS signal and the remote controller signal lost for more than 6 seconds, the aircraft will not Return-to-Home but descend slowly until land to the ground and lock the aircraft.

Low voltage RTH



When the aircraft rear lights flash red slowly, battery icon “” is shown on the LCD screen, and steady beep, beep, beep..., beep, beep, beep sound is heard. At this moment, as long as the aircraft flying altitude is over 100 meters or the flying distance is over 300 meters, the aircraft will automatically fly back to the Home Point.

When the aircraft rear lights flash red slowly, battery icon “” is shown on the LCD screen, and steady beep..., beep..., beep sound is heard. At this moment, as long as the aircraft flying altitude is over 15 meters or the flying distance is over 15 meters, the aircraft will automatically fly back to the Home Point. If the aircraft flying altitude is less than 15 meters or the flying distance is less than 15 meters, the aircraft will automatically land to the ground.



Attention: When aircraft is in low voltage RTH status you can not regain control of the aircraft by pressing the RTH button.

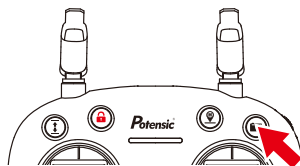

Photo/Video

Short-press the button indicated as below and the camera icon “” on the LCD screen flashes once, the camera takes one photo; Long-press the same button, the video icon “” on the LCD screen flashes slowly, the camera is taking video. Long-press again to exit shooting.



Attention: When the aircraft is not inserted with TF card or the TF card is malfunction, photos and videos taking can not be done by pressing the button of the remote controller, but by the icon on the APP interface.

Low voltage warning

- When the battery icon “” is shown on the LCD screen, and the aircraft front lights glow solid on and the rear lights keep flashing slowly, it means that the battery of aircraft is nearly low voltage.
- When the battery icon “” is shown on the LCD screen, and the aircraft front lights glow solid on and the rear lights keep flashing rapidly, it means that the battery of aircraft is in low voltage.



Pic. 1



Pic. 2

Signal strength indicator

Signal strength “” shows the strength of the received signal. The more, the better.



Prepare the flight

Before you take off, check and make sure that

1. The aircraft and the remote controller are full charged.
2. The propellers are installed correctly.
3. The motors work normally after unlocking.

Basic flight operation steps

1. Connect the remote controller with the aircraft and then proceed aircraft initialization detection.
2. Aircraft compass calibration.
3. Unlock the aircraft after the gyro detection of the aircraft is completed.
4. Pull up the throttle stick then the aircraft takes off, and control the aircraft flight by left/right stick.
5. Pull down the throttle stick to the bottom position and keep for 3 seconds to lock the aircraft.
6. Pull out the battery from the aircraft and then turn off the remote controller.

FPV software download and installation



Where to download “Potensic-M2” APP

- For Apple IOS system, please turn to Apple store, search “Potensic-M2” or scan the QR code at right side to download the software.



- For Android system, please turn to Google play, search “Potensic-M2” or scan the QR code at right side to download the software.

How to link the “Potensic-M2” to the camera

Power on the aircraft, then enter phone settings option. Turn on WiFi, find drone**** on the list and connect it. When “” legend is shown, it means WiFi connecting is successful. Exit settings and tap “Potensic-M2” APP at your mobile device, then select your aircraft model on the home page; click “” to enter into the real-time image transmission interface.

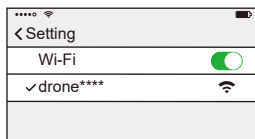

Connect WIFI



Potensic-M2

Tap “Potensic-M2” App



Click “GO”

Photos and video saving feature:

1. If the camera is without TF card, videos and photos will be saved at the APP.
2. If the camera is with TF card, videos and photos will be saved at the TF card.
3. Videos and photos in the TF card can be downloaded to the APP.







Attention:

- Please make sure that your mobile device supports 5G WIFI before linking Potensic-M2 to your device.
- Mounted the “Potensic-M2” APP on your mobile device and connect “Potensic-M2” to the camera, your aircraft will be capable of flying in the intelligent flight modes: Follow Me, Point of Interest and Waypoint flight.
- Beginners are suggested to press “Help” button to learn about the camera operation method.





App New Function

























1. Refresh button “” on left: Please click this button to refresh image if it freezes up during flight.
2. Maps button “” “” on right: Plane Imagery Map “” It shows position and place name only. Satellite Imagery maps “”: It shows scene. These two maps could be switched freely during flight. Besides, please update Google Maps APP before connecting drone to phone.

Product components

Basic parts

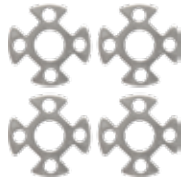
			
Upper cover B3PROV201	Main frame B3PROV202	Propeller A/B B3PROV203	High landing gear B3PROV204

			
LED light parts B3PROV205	Lamp cover of the front and rear light B3PROV206	Battery B3PROV207	Plastic plug B3PROV208
			
LED Light holder B3PROV209	Screws pack B3PROV210	Front/Rear light bar B3PRO06	Front ESC parts B3PRO07
			
Flight-control board B3PRO08	Clockwise motor B3PRO09	Counter-clockwise motor B3PRO10	Transparent plastic part B3PRO11
			
Rear ESC parts B3PRO13	Charging converter B3PRO14	Interleaving paper B3PRO16	Propeller changing tool B2P10

			
GPS Module B2C008	Compass B2C011	Heat sink B80018	Camera mount G6000
			
Mobile phone holder C5000S	Remote controller GR6221A		

Optional accessories

			
FHD Recording Camera C4000	720P HD 5G WIFI Camera C5000	1080P FHD 5G WIFI Camera C6000	

Trouble shooting

No.	Phenomenon	Solution
1	The lights are flashing quickly.	The Gyro of the aircraft is under signal detecting condition, set the aircraft to any flat surface.
2	The aircraft can't be kept balance after taking off and lean one side.	Lay the aircraft in the flat surface or flat ground and proofread the gyro of the aircraft again.
3	The aircraft is shaking fiercely.	The rotor propellers are out of shape, change the propellers.
4	The aircraft fails to unlock and the rear lights flash slowly.	The battery is under low power status, please charge the battery to full.

Note:

- a) Changes or modifications not expressly approved by the party responsible for compliance could void the user's authority to operate the equipment.
- b) This equipment has been tested and found to comply with the limits for a Class B digital device, pursuant to part 15 of the FCC Rules. These limits are designed to provide reasonable protection against harmful interference in a residential installation. This equipment generates, uses and can radiate radio frequency energy and, if not installed and used in accordance with the instructions, may cause harmful interference to radio communications. However, there is no guarantee that interference will not occur in a particular installation. If this equipment does cause harmful interference to radio or television reception, which can be determined by turning the equipment off and on, the user is encouraged to try to correct the interference by one or more of the following measures:
- Reorient or relocate the receiving antenna.
 - Increase the separation between the equipment and receiver.
 - Connect the equipment into an outlet on a circuit different from that to which the receiver is connected.
 - Consult the dealer or an experienced radio/TV technician for help.

