



14+
age

Instructions For Use

日本語マニュアル

Gebrauchsanweisung

V 3.0

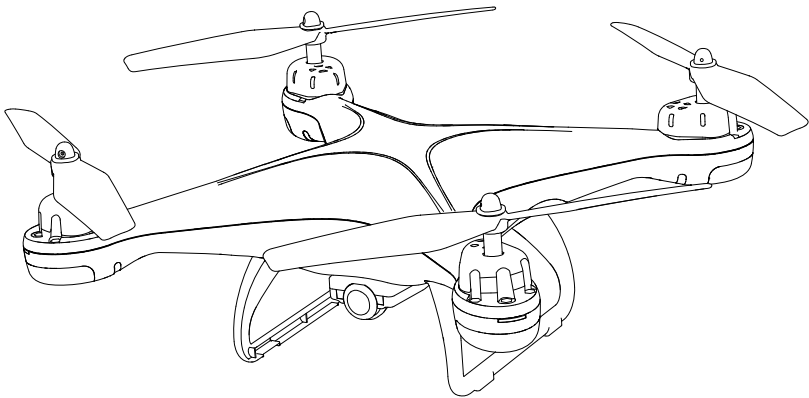

HS110G



usa@holystone.com (USA)
ca@holystone.com (CA)

eu@holystone.com (EU)
jp@holystone.com (JP)



+1(855) 888-6699

www.holystone.com

● English 1-34●

● 日本語 35-63●

● Deutsch 64-95●

Contents

1.0 Disclaimer&Warning	01
2.0 Safety Guidelines	01
3.0 Maintenance	05
4.0 Package Contents	06
5.0 Drone’s Details	07
6.0 Transmitter Details	08
7.0 Joystick Mode	09
8.0 Installation	
8.1 Propellers	10
8.2 Landing Gear	11
8.3 Camera	11
9.0 Charging	12
10.0 Using the Application	
10.1 Download APP	13
10.2 Using the Application	13
11.0 Operation Guide	
11.1 Paring	14
11.2 Calibrating the Compass	15
11.3 Calibrating the Gyro	16
11.4 GPS Searching	17
11.5 Unlock the Motor	18
11.6 One Key Takeoff / Landing	18
12.0 Functions Details	
12.1 APP Functions	19
12.2 Beginner’s Mode	21
12.3 Speed Switch	22
12.4 Emergency Stop	22
12.5 Trimmer Function	23
12.6 Headless Mode	24
12.7 Return to Home	25
13.0 Specifications	26
14.0 Trouble Shooting	28
15.0 Contact Us	28
16.0 General Information	29

1.0 DISCLAIMER & WARNING

1. Please read this Disclaimer & Warning and Safety Guidelines carefully before using our product. This product is not recommended for people under the age of 14. By using this product, you hereby agree to this disclaimer and signify that you have read it fully. You agree that you are responsible for your own conduct and any damaged caused while using this product, and its consequences . You agree to use this product only for purposes that are proper and in accordance with local regulations, terms and all applicable polices and guidelines Holy Stone may make available.

2. When using this product, please be sure to strictly abide by the specification requirements and safety guidelines stated in this document. Any personal injury property damage, legal disputes and all other adverse events caused by the violation of the safety instructions or due to any other factor, WILL NOT be Holy Stone's responsibility.

2.0 SAFETY GUIDELINES

2.1 Check Before Use:

① This product is a high precision drone that integrates various electronic stability and control mechanisms. Please be sure to setup this drone carefully and correctly to ensure safe, accident-free operation.

② Please be sure that the batteries of the drone and transmitter are clean, undamaged and, fully charged.

③ Please be sure that all the propellers are undamaged and are installed in the correct orientation.

④ Please do a thorough check of the product before each use. Inspect the integrity of the parts, any signs of cracks and wear of the propeller, battery power and effectiveness of the indicator, etc. If after doing a complete check any issues are found, please refrain from using the product until the issue has been resolved.

2.2 Flight Environment:



Fly in Open Areas

**Maintain Line
of Sight**

**Fly Below
390 feet (120 m)**



Avoid flying over or near obstacles, crowds, high voltage power lines, trees, airport or bodies of water.

DO NOT fly near strong electromagnetic sources such as power lines and base stations as it may affect the onboard compass.



Don't use this drone in adverse weather conditions such as rain, snow, fog, and wind.

2.3 Operation Requirements:

- ① Please don't use this product to follow any moving vehicles .
- ② During the flight, only turn off the motor in case of an emergency.
- ③ Please flight the drone back to you as soon as possible when the battery is running low.
- ④ This product should not be used while drinking alcohol, if you are feeling fatigued, taking medicine, or feeling any physical discomfort.
- ⑤ Beware of the noise volume the drone produces. Keep your distance to avoid ear damage.



⑥ Stay away from the rotating propellers and motors.

⑦ Don't fly in the No-Fly Zone.

2.4 Use of Battery:

- ① Please ensure batteries are fitted in the correct orientation as shown in the instruction manual.
- ② Avoid short circuits by fitting the batteries incorrectly, and do not crush or squeeze the batteries as this could carry the risk of an explosion.
- ③ Do not mix new and old batteries as this can lead to a poor performance of the product.
- ④ Dispose used batteries carefully, do not litter.
- ⑤ Please keep dead batteries away from heat and fire.
- ⑥ If the device is not going to be used for an extended period of time, remove batteries to prevent potential damage from battery leakage.

- ⑦ It is recommended to only use the USB charging cable that comes with the drone to charge the battery.
- ⑧ Don't connect the battery directly to wall outlets or car cigarette lighter sockets.
- ⑨ Don't attempt to disassemble or modify the battery in any way.
- ⑩ Don't use the battery if it gives off an odor, generates heat, becomes discolored or deformed, or appears abnormal in any way. If the battery is in use or being charged, remove it from the device or charger immediately and discontinue use.
- ⑪ Don't pierce the battery casing with a nail or other sharp object, break it open with a hammer, or step on it!
- ⑫ Always charge the batteries in a fireproof container and away from combustible materials. Don't charge on surfaces that can catch fire. This includes: wood, cloth, carpet, or in the application's device.
- ⑬ Don't immerse the battery in water or allow it to get wet.
- ⑭ Don't solder battery terminal directly.
- ⑮ Keep battery out of reach of children or pets.
- ⑯ Don't short-circuit the battery by connecting wires or other metal object to the positive(+) and negative(-) terminals.



Li-Po Battery Disposal & Recycling





Waste Lithium-polymer batteries must not be placed with household trash. Please contact local environmental or waste agency or the waste agency or the supplier of your model or your nearest Li-Po battery recycling center.

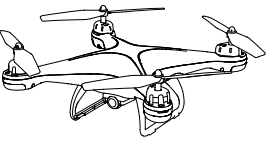
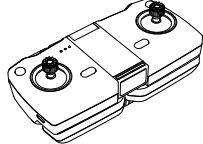
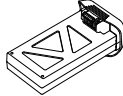
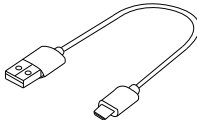
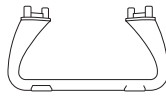
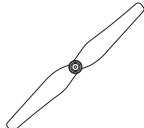

3.0 MAINTENANCE

- ① Clean the product after each use with a clean, soft cloth.
- ② Avoid prolonged exposure to direct sunlight and avoid buildup of heat on the drone.
- ③ This device is not waterproof and must not be submerged in water under any circumstance. Failure to maintain the device completely dry will result in the failure of the unit.
- ④ Check the charging plug and other accessories for signs of damage frequently. If any part of the device is damaged, refrain from flying until maintenance can be carried out.

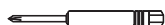
4.0 PACKAGE CONTENTS

 <p style="text-align: right;">× 1</p>	 <p style="text-align: right;">× 1</p>	 <p style="text-align: right;">× 1</p>
<p style="text-align: center;">Drone</p>	<p style="text-align: center;">Transmitter</p>	<p style="text-align: center;">Drone Battery</p>
 <p style="text-align: right;">× 1</p>	 <p style="text-align: right;">× 2</p>	 <p style="text-align: right;">× 4</p>
<p style="text-align: center;">USB Charging Cable</p>	<p style="text-align: center;">Landing Gear</p>	<p style="text-align: center;">Spare Propeller</p>
 <p style="text-align: right;">× 6</p>	 <p style="text-align: right;">× 1</p>	 <p style="text-align: right;">× 1</p>
<p style="text-align: center;">Screws</p>	<p style="text-align: center;">Screwdriver</p>	<p style="text-align: center;">Instructions For Use</p>

5.0 DRONE'S DETAILS

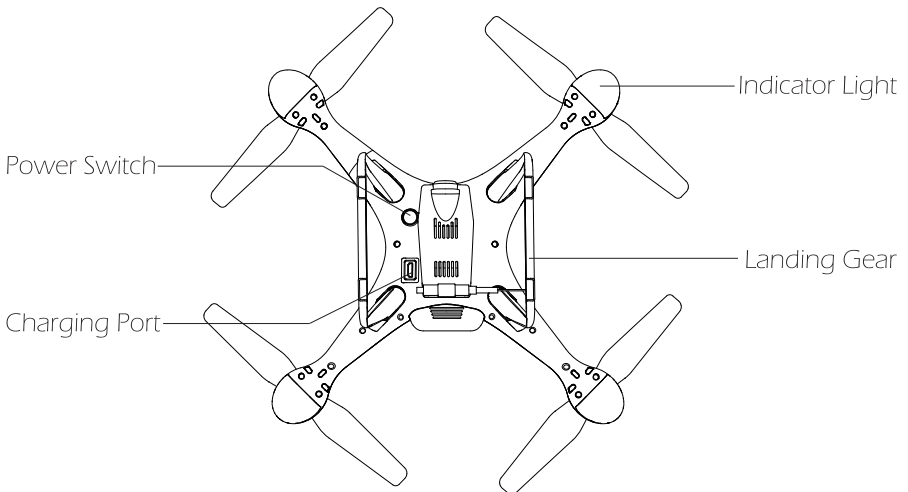
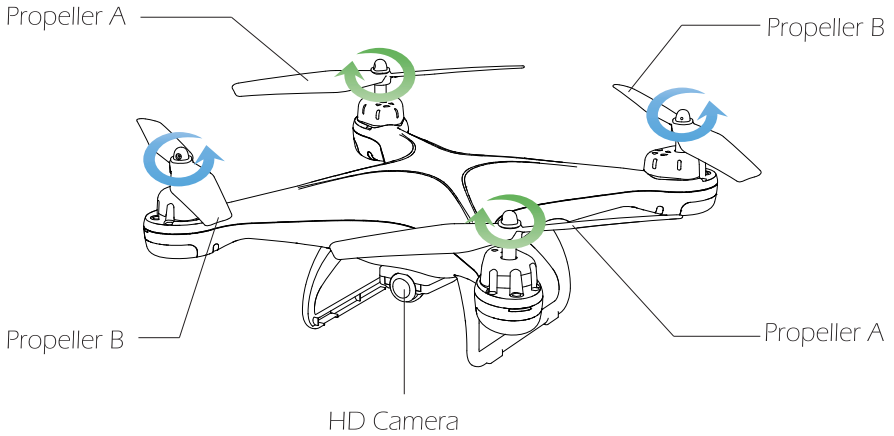

6.0 TRANSMITTER DETAILS

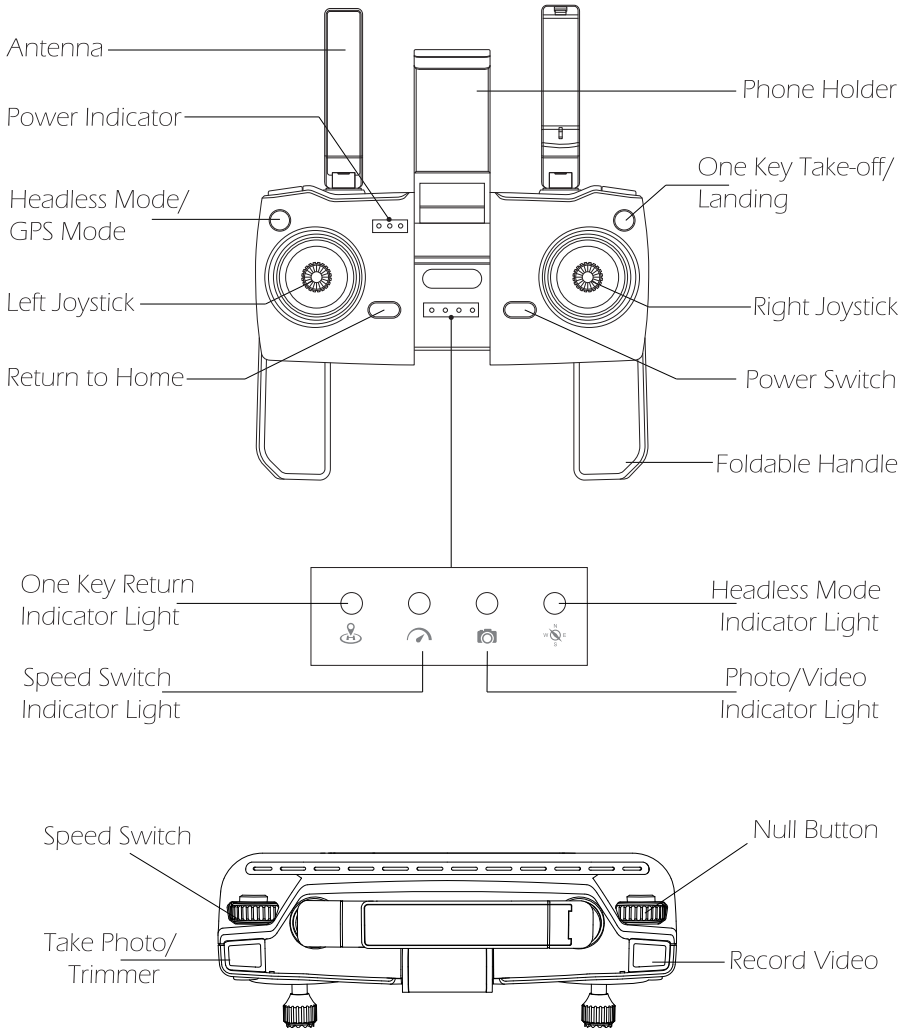

ATTENTION:

Press “  ” shortly, then quickly press and hold “  ” for about 2 seconds to turn off the power of the transmitter.

7.0 JOYSTICK MODE

► 7.1 MODE 2 (Left hand throttle MODE 2 will be default setting.)

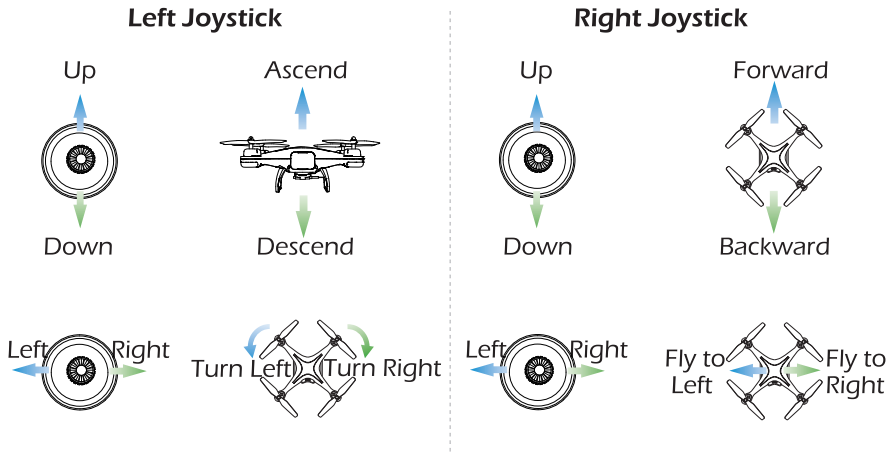

► 7.2 MODE 1

To enter MODE 1, turn on the transmitter while holding the "Take Photo / Trimmer" button. (Please do not release the "Take Photo / Trimmer" button until the transmitter is powered on.)

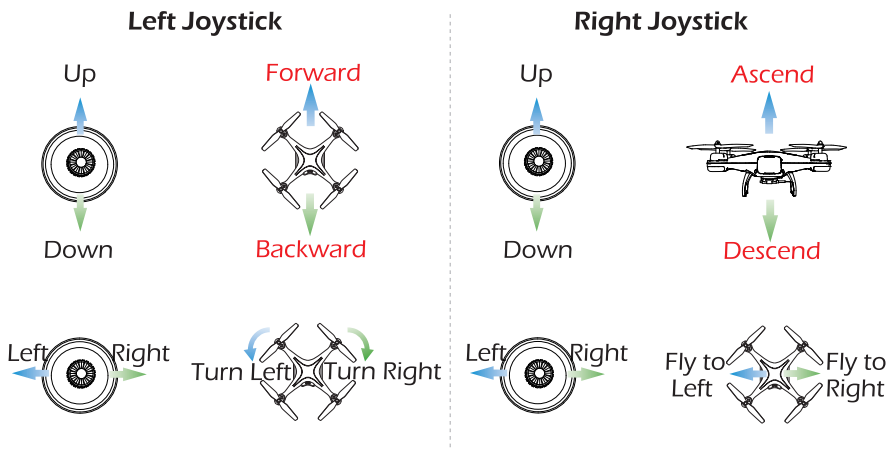

8.0 INSTALLATION

► 8.1 Propellers

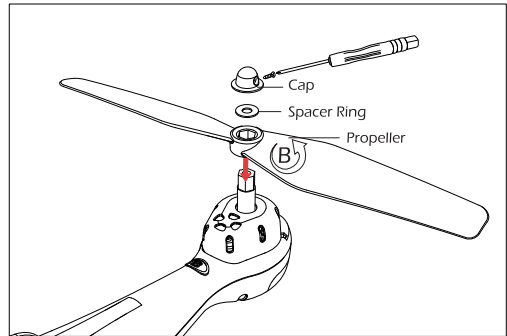
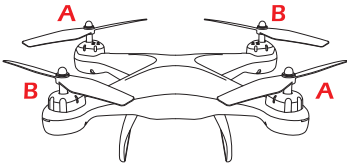

Please note that the letter "A" or "B" is printed on each propeller. Make sure all the propellers are attached in the correct motor position.

Install the propeller, spacer ring, propeller cap and screw to the motor shaft to fix.

► 8.2 Landing Gear

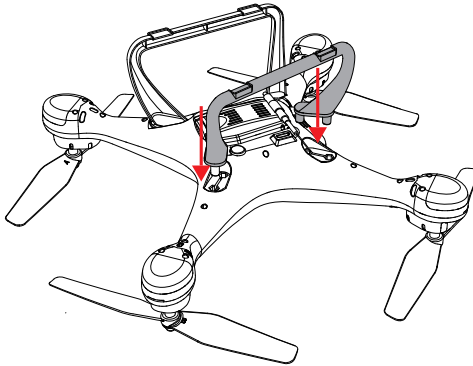

As shown in the figure above, please install the Landing Gear on the bottom of the drone.

► 8.3 Camera

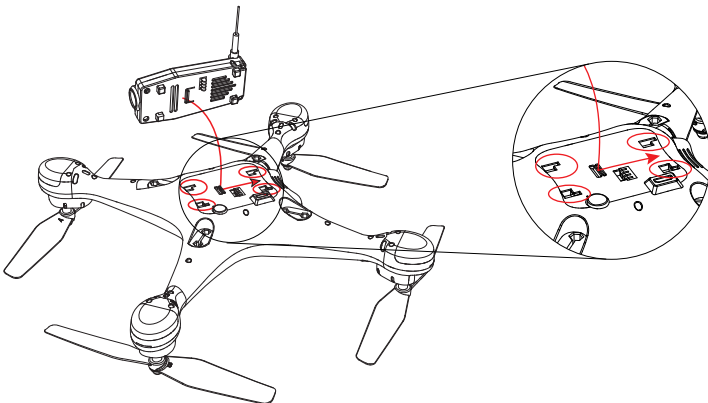

- 1) According to the above diagrams, please make sure that the camera is mounted on the four camera slots at the bottom of the fuselage, then pull the camera backward to lock it.
- 2) Push the camera forward to take it out.

9.0 CHARGING

► 9.1 Drone Battery

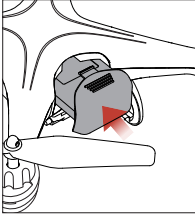

Push the battery into the battery compartment.

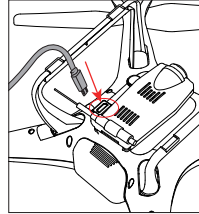

Charging time: 180 minutes
(Depending on charging power)

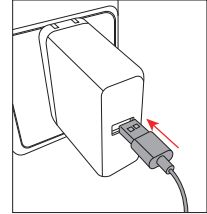
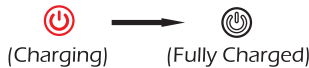

Phone adapter:
5V \equiv 1A/2A
(Not included)

Connect the USB charging cable to the charging port of the drone, then, connect the USB charging cable to a computer or a USB adapter.

► 9.2 Transmitter Battery

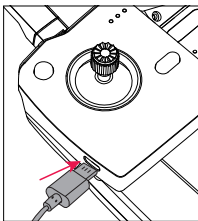

Charging time of the transmitter: about 60 minutes

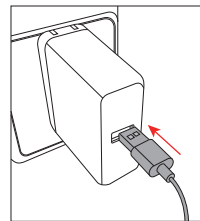
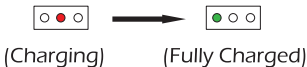

Phone adapter:
5V \equiv 1A/2A
(Not included)

Connect the USB charging cable with the transmitter, then, connect the USB charging cable to a computer or a USB adapter.



- When the transmitter is in low power, the “Power Indicator” on the transmitter will blink constantly.
- Before charging, please check the contents of the “Use of Battery” section of the “Safety Guidelines” carefully!

10.0 USING THE APPLICATION

► 10.1 Download APP



iOS



Android APP on Google play

Scan the QR code, connect to the App Store™ or Google™ Play and download the “**HS GPS V1**” application for free.

► 10.2 Using the Application

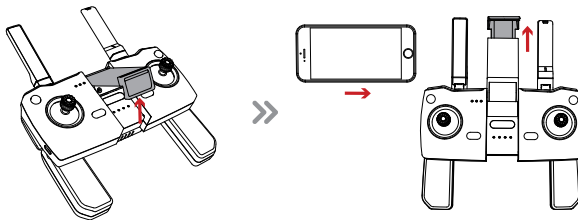

- ① As shown above, pull up the phone holder and lock the phone.
 - ② Connect your smart phone to the Wi-Fi of the drone and check the drone's status on the “**HS GPS V1**” App.
 - ③ On your smart phone, launch a search of the available Wi-Fi networks:
 - ④ Select the Wi-Fi network: **HolyStoneFPV_*******.
 - ⑤ Wait for your smart phone connect to the Wi-Fi network of the drone. **This connection is generally represented by the Wi-Fi logo appearing on your smart phone's screen.**
 - ⑥ Enter the **HS GPS V1** application.
- > The connection between your smart phone and the drone is established automatically.

11.0 OPERATION GUIDE

All of the following operations on this manual is under MODE 2.

► 11.1 Pairing

① Insert the battery into the drone, and then press the Power Switch to turn on the drone.

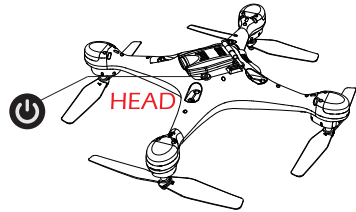

② Place the drone on a flat and level surface with the head forward and the tail towards the pilot.

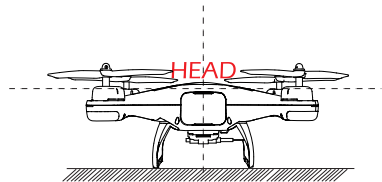

③ Press the  button to turn on the transmitter.

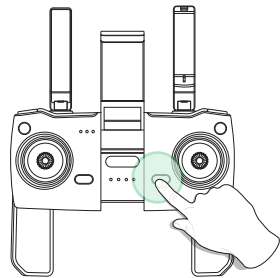

④ Push the left joystick up then down to pair the drone with the transmitter. Two beeps will be heard from the transmitter, and the LED indicator lights on the drone is pink in front and purple in back if the drone is paired successfully.

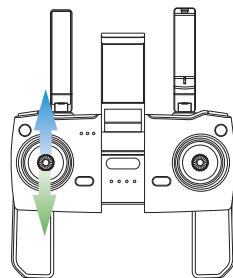

► 11.2 Calibrating the Compass

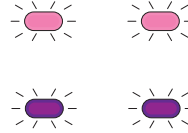
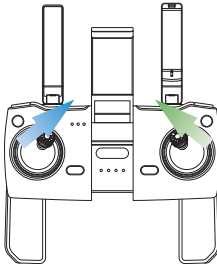

Step 1:

Simultaneously push the left stick to top right corner and the right stick to the top left corner. The front Pink lights and the rear Purple light will turn to flash quickly.

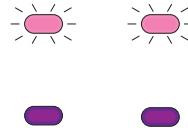
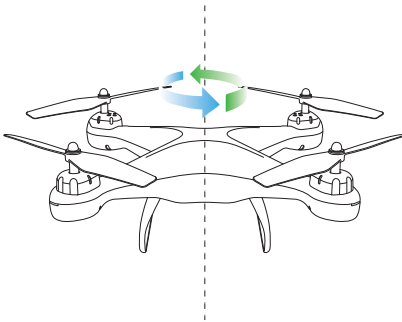

Step 2:

Hold the drone horizontally and rotate it until the rear lights turn solid Purple.

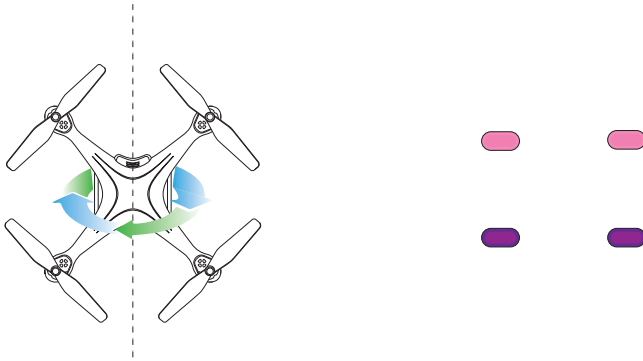

Step 3:

Hold the drone vertically and rotate it until the front Pink lights turn solid.

► 11.3 Calibrating the Gyro

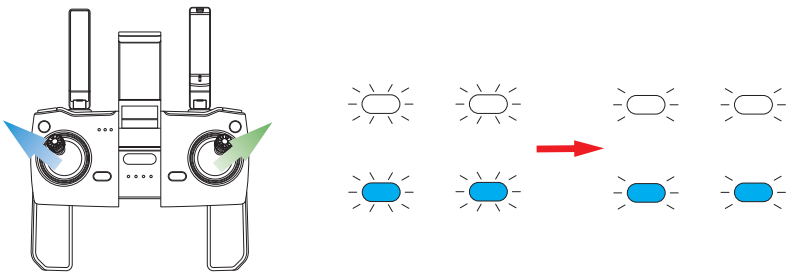

Simultaneously push the left stick to top left corner and the right stick to the top right corner. When the drone's front white indicator light and rear blue indicator light change from quick flash to slow flash, and the camera turns once, the gyroscope calibration is completed.

Tips: To ensure a stable flight, we suggest that the pilot calibrates the gyro every time after pairing the drone and after a crash.

► 11.4 GPS Searching (DO NOT use GPS Mode indoors)

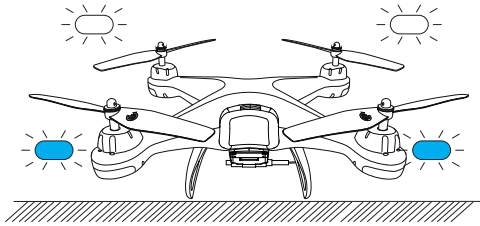

– Place the drone on a flat and dry surface where is unobstructed and lit area.

– The front White indicator light and the rear Blue indicator will flash quickly. This means the drone is searching the GPS Signal.

This process will take about one minute.

When four lights turn solid, GPS Mode is Ready (Only when the drone is connected to GPS successfully can it take off).

– Blue (back) and white (front) lights are all solid (no blinking).

ATTENTION:

① If the LED Flight Indicators keep blinking quickly, it indicates drone is searching for GPS signals.

② If the drone keep blinking quickly after a few minutes, it indicates that the process has FAILED. Please taking the drone one meter or so from the ground, and repeat all the Compass Calibration operations until the process is successful.

③ When flying indoors, please hold  button for 3 seconds to exit GPS Mode, and the LED lights will blink slowly. You can fly this drone when you complete the Compass Calibration operations if you exit GPS mode.

► 11.5 Unlock the Motor

Simultaneously push the left stick to lower right corner and the right stick to the lower left corner. The propellers rotate, indicating the drone is unlocked.

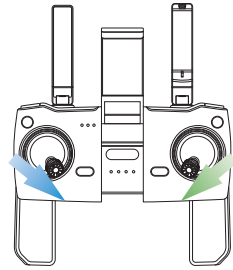

► 11.6 One Key Takeoff/ Landing

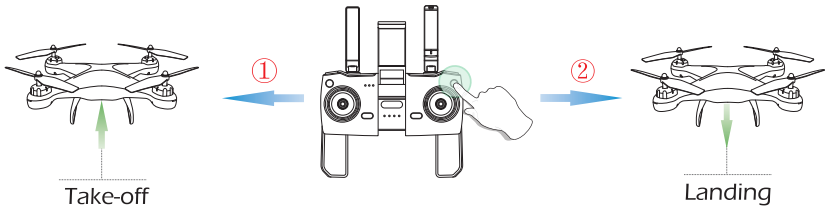









① Press the One Key Takeoff button (⬆️⬆️⬆️), the drone will automatically takeoff and hover at about 5 feet altitude.











② When the drone is flying, press the One Key Landing button (⬆️⬆️⬆️), the drone will automatically land on the ground.

12.0 FUNCTIONS DETAILS

► 12.1 APP Functions



	<p>Return: Returns the main interface.</p>
	<p>Controls ON/OFF</p>
	<p>Tapfly: The drone will fly the path connecting the points on the map set by the operator. <i>(It is recommended to enlarge the map.)</i></p>
	<p>Media Gallery: Photos or video can be viewed.</p>
	<p>Flight Record: Tap to view historical data on flight date, distance, speed and altitude.</p>
	<p>3D VR: Match with VR glasses <i>(Not included)</i> to watch 3D images in real time.</p>
	<p>Flip Screen: Application interface can be 180 ° flip.</p>
	<p>GPS Signal: Displays current GPS signal strength.</p>
	<p>Setting: Tap the icon to enter the setting interface, settings for flight height / distance and return altitude.</p>

	<p>Follow Me: There are two modes of Follow Me Mode and Lock Follow Mode.</p>
	<p>Follow Me Mode: The drone stays at a distance from the operator and following the GPS position of the phone.</p>
	<p>Locked Follow Mode: After locking the following target, the camera is always oriented towards the following target, but the position of the drone remains unchanged. <i>(The following target should not move too fast to avoid following loss.)</i></p>
	<p>Return to Home: The drone will return to the last recorded Take-Off Point.</p>
	<p>Auto Take-off: The drone will take off automatically to a height of 5ft.</p>
	<p>Auto Landing: The drone will land slowly on the ground.</p>
	<p>Take Photo: Tap to take one photo at a time.</p>
	<p>Take Video: Tap once to start recording; tap again to stop recording.</p>
	<p>Sound Recording: The device can record the operator's voice while the camera is recording.</p>
	<p>Transmitter Battery Level: Real-time display of the current remaining battery level of the transmitter.</p>
	<p>Drone Battery Level: Real-time display of the current remaining battery level of the drone.</p>
<p>Waiting for GPS Signal</p> <p>↓</p> <p>Drone Status</p>	<p>Speed (Meter/Sec.)</p> <p>D:00 H: 0.0 DS: 0.0 VS: 0.0</p> <p>Height (Meters)</p> <p>Distance (Meters)</p>

► 12.2 Beginner's Mode

The Default GPS Mode is Beginner Mode, Under Beginner Mode:

1. Flight Distance is limited between 0~30m / 0~98.4feet.
2. Flight Altitude is limited between 0~30m / 0~98.4feet.
3. RTH Altitude is under 25m / 82feet.



After entering the APP settings page (as shown above) , users can turn off the Beginner Mode to enter the Advanced Mode, and modify the operation parameters.

You only can Turn-off the Beginner Mode to modify the parameters in the APP on your phone after you complete the Compass Calibration operations.

► 12.3 Speed Switch

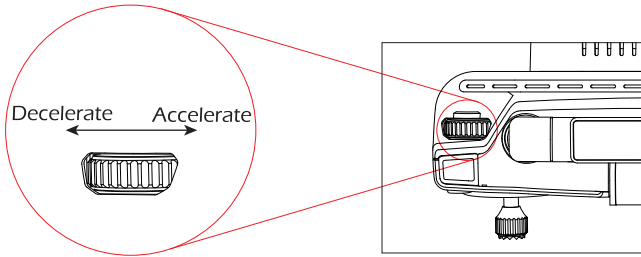

This drone comes with 3 speed modes (Low/ Medium/ High). Dial the wheel (⊖_{SPEED}⊕) to the right to accelerate. Dial to the left to decelerate. If the Speed Status Light on the transmitter is turned off, it means the drone is in low speed. If the light is turned on, it means the drone is in medium speed. If the light is blinking, it means the drone is set to high speed. (Medium Speed is default setting!)

► 12.4 Emergency Stop

 The Emergency Stop function should only be used in case of the emergency during the flight to avoid any damage or injury.

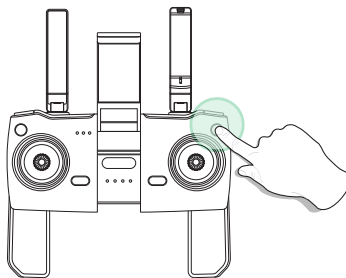

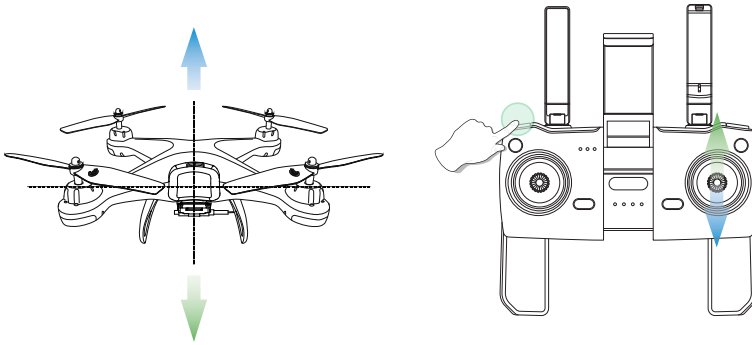

Press and hold One Key Takeoff / Landing button () for 2 secs, the motors will stop immediately and the drone will fall directly.

► 12.5 Trimmer Function (Trim under NO GPS Mode)



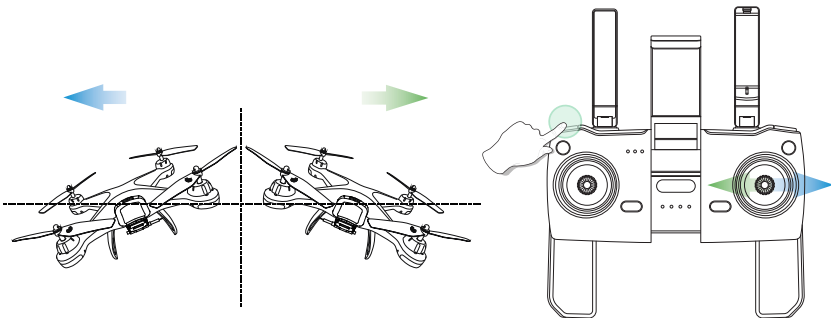

F/B Sideways Drift Trim : If the drone drifts forward, hold down the Trimmer button () and do not release it while pushing the direction joystick down to balance the drone. If the drone drifts backwards, hold down the Trimmer button and do not release it while pushing the direction joystick up to balance the drone.



L/R Sideways Dip Trim : If the drone drifts left, hold down the Trimmer button () and do not release it while pushing the direction joystick right to balance the drone. If the drone drifts right, hold down the Trimmer button and do not release it while pushing the direction joystick left to balance the drone.

► 12.6 Headless Mode

1. Press the Headless Mode button () on the transmitter. A beep will be heard from the transmitter, and the Headless Mode Indicator on the transmitter lights up, indicating that the drone enters Headless Mode.
2. Press the Headless Mode button () again, and you will hear one long beep, the Headless Mode Indicator on the transmitter is off which indicates the drone exits the Headless Mode.

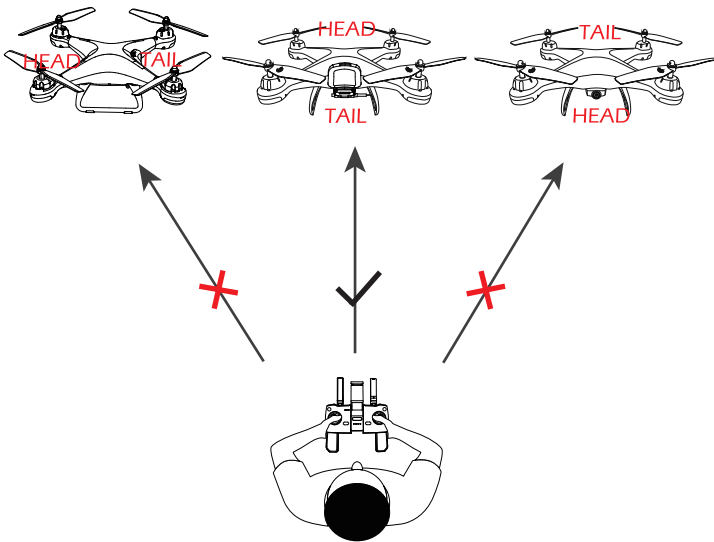

Please make sure the pilot stays in the same orientation as the drone head is facing when the drone takes off.

Under Headless Mode, the forward direction is the direction that the head of the drone faces when the drone takes off.

In order to make sure the pilot can tell the drone's direction, we recommend that pilots stay in the same orientation as the drone head faces when the drone is taking off.

If so, when the pilot pushes the direction joystick forward/ backward, the drone will fly forward/ backward toward him/ her. If the pilot moves the right stick left/ right, the drone will move left/ right relative to the pilot.

► 12.7 Return to Home (RTH)

The Return to Home (RTH) function brings the drone back to the last recorded Take-Off Point. **This function can only be achieved in GPS mode.**

There are three types of RTH:

Smart RTH / Low-Battery RTH / Failsafe RTH.

12.7.1 Smart Return To Home

Press the Return to Home button () on your transmitter, and the transmitter will start beeping.

Your drone will return to the Take-Off Point. Press the button () again to stop RTH procedure. Push the throttle joystick down to land the drone on a safe area.

12.7.2 Low-Battery RTH

Low-Battery RTH is triggered when the flight battery level is low. When Low-Battery RTH is activated, the drone will fly back to where you are from about 100 feet, and you can still control your drone. Push the throttle down to land the drone in a safe area. When the power of drone is completely empty, drone will return to the TakeOff point where you set.

12.7.3 Failsafe RTH

Drone will enter Return to Home Mode if the signal between the drone and the transmitter lost. The drone will fly back to where you are from about 100 feet, and the drone will rebind to the transmitter by itself. When the drone flies back into your view, you can control it again.



- **This drone is NOT equipped with obstacle-avoidance.**
- **Do not push the Direction Stick when entering Low-Battery RTH, if push will make return flight invalid, the drone has the risk of losing.**

13.0 SPECIFICATIONS

DRONE

Model: HS110G

Weight: 176g/ 6.2oz

Flight Time: < 13 minutes

Motor Model: 1020

Operating Temperature Range: 32° to 104°F

Dimensions: 306 x 193 x 91 mm

TRANSMITTER

Operating Frequency: 2.4 GHz

MAX Transmission Distance: 984 feet (outdoors and unobstructed)

Battery Type: 3.7V 300mAh Li-Po battery

Charging Time: about 60 mins

Operating Temperature Range: 32° to 104°F

DRONE BATTERY

Capacity: 1500 mAh

Voltage: 3.7 V

Battery Type: Li-Po

Charging power: 5~10W

Charging Temperature Range: 41° to 104°F (5° to 40°C)

Charging Time: about 180 mins

CAMERA

Video/Photo Resolution: HD 1920×1080p (stored in TF card)
HD 1280×720p (stored on mobile phone)

Lens: FOV 110°/2.0

FPV Distance: ≤ 492 feet (outdoor and unobstructed)

Photo: JPEG

Video: AVI

Transmission Frame Rate: 25 fps

MAX Supported TF Cards: 32 GB (Not included)

Operating Temperature Range: 32° to 104°F

USB CHARGING CABLE

Voltage: 5 V

Rated Power: ≤10 W

14.0 TROUBLE SHOOTING

Problems	Reasons	Solutions
Drone flashes and don't respond to the transmitter during operation.	<ol style="list-style-type: none"> 1. Transmitter is not paired to the drone. 2. Insufficient battery power. 	<ol style="list-style-type: none"> 1. Refer to the Manual and re-pair the drone. 2. Recharge the battery.
The propellers spin, but the drone cannot take-off.	<ol style="list-style-type: none"> 1. Insufficient battery power. 2. The propellers are installed in wrong orientation. 3. The propellers are distorted. 	<ol style="list-style-type: none"> 1. Recharge the battery. 2. Install the propellers in right orientation. 3. Replace the propellers.
The drone shakes heavily.	The propellers are distorted.	Replace the propellers.
Drone cannot stay balanced in flight.	<ol style="list-style-type: none"> 1. The propellers are distorted. 2. The motor doesn't work properly. 	<ol style="list-style-type: none"> 1. Replace the propellers. 2. Replace the motor.
Drone is unstable after crashing.	Four-axis acceleration sensor loses it's balance after crashing.	Restart and re-calibrate the drone.

15.0 CONTACT US

Please do not hesitate to contact us if you need further support.



usa@holystone.com (America)

ca@holystone.com (Canada)

eu@holystone.com (Europe)

jp@holystone.com (Japan)



+1(855) 888-6699

16.0 GENERAL INFORMATION

FCC Notice:

This device complies with Part 15 of the FCC Rules.

Operation is subject to the following two conditions:

- (1) This device may not cause harmful interference.
- (2) This device must accept any interference received, including interference that may cause undesired operation.

NOTE: This equipment has been tested and found to comply with the limits for a Class B digital device, pursuant to Part 15 of the FCC Rules. These limits are designed to provide reasonable protection against harmful interference in a residential installation. This equipment generates uses and can radiate radio frequency energy and, if not installed and used in accordance with the instructions, may cause harmful interference to radio communications. However, there is no guarantee that interference will not occur in a particular installation. If this equipment does cause harmful interference to radio or television reception, which can be determined by turning the equipment off and on, the user is encouraged to try to correct the interference by one or more of the following measures:

- Reorient or relocate the receiving antenna.
- Increase the separation between the equipment and receiver.
- Connect the equipment into an outlet on a circuit different from that to which the receiver is connected.
- Consult the dealer or an experienced radio/TV technician for help.

WARNING: Changes or modifications not expressly approved by the party responsible for compliance could void the user's authority to operate the equipment.

RF Exposure

The equipment complies with FCC radiation exposure limits set forth for an uncontrolled environment. This device should be installed and operated with minimum distance 20cm between the radiator & your body.

IC Notice:

This device complies with Canada Industry licence-exempt RSS standard(s). Operation is subject to the following two conditions:

- (1) this device may not cause interference; and
- (2) this device must accept any interference. Including interference that may cause undesired operation of the device.

CAN ICES-3 (B)

Avis d'Industrie Canada

Le présent appareil est conforme aux CNR d'industrie Canada applicables aux appareils radio exempts de licence. L'exploitation est autorisée aux deux conditions suivantes:

- 1) l'appareil ne doit pas produire de brouillage; et
- 2) l'utilisateur de l'appareil doit accepter le brouillage radioélectrique subi même si le brouillage est susceptible d'en compromettre le fonctionnement. mauvais fonctionnement de l'appareil. Cet appareil numérique de la classe B est conforme à la norme NMB-003 du Canada.

CAN NMB-3 (B)

RF Exposure

Radiation Exposure Statement:

This equipment complies with IC radiation exposure limits set forth for an uncontrolled environment. This equipment should be installed and operated with minimum distance 20cm between the radiator & your body.

Déclaration d'exposition aux radiations:

Cet équipement est conforme aux limites d'exposition aux rayonnements IC établies pour un environnement non contrôlé. Cet équipement doit être installé et utilisé avec un minimum de 20 cm de distance entre la source de rayonnement et votre corps.

HOW TO RECYCLE THIS PRODUCT

This symbol on the product or its documentation indicates that it must not be disposed of with household waste.

Uncontrolled waste disposal may harm the environment or human health.

Please separate your device from other types of waste to recycle it responsibly.

This will help to foster the sustainable re-use of material resources.

We invite you to contact your retailer or inquire at your local town hall to find out where and how the drone can be recycled.



BATTERY WARNING:

1. Failure to follow all the instructions may result in serious injury, irreparable damage to the battery and may cause a fire, smoke or explosion.
2. Always check the battery's condition before charging or using it.
3. Replace the battery if it has been dropped, or in case of odor, overheating, discoloration, deformation or leakage.
4. Never use anything other than the approval LiPo charger the battery. Always use a balancing charger for LiPo cells or a LiPo cell balancer. It is recommended that you do not to use any other charger than the one provided with the product.
5. The battery temperature must never exceed 60°C (140°F) otherwise the battery could be damaged or ignite.
6. Never charger on a flammable surface, near flammable products or inside a vehicle (preferably place the battery in a non-flammable and nonconductive container).
7. Never leave the battery unattended during the charging process. Never disassemble or modify the housing's wiring, or puncture the cells. Always ensure that the charger output voltage corresponds to the voltage of the battery. Do not short circuit the batteries.
8. Never expose the LiPo battery to moisture or direct sunlight, or store it in a place where temperatures could exceed 60°C(car in the sun, for example).
9. Always keep it out of reach of children.
10. Improper battery use may result in a fire, explosion or other hazard.
11. Non-rechargeable batteries are not to be recharged. Rechargeable batteries are only to be charged under adult supervision.
12. Different types of batteries or new and used batteries are not to be mixed.

13. Batteries are to be inserted with the correct polarity.
14. The supply terminals are not to be short-circuited. Regular examination of transformer or battery charger for any damage to their cord, plug, enclosure and other parts and they must not be used until the damage has been repaired.
15. The packaging has to be kept since it contains important information.
16. The toy is only to be connected to Class II equipment bearing the symbol. 

EU RF Power(EIRP): 10dBm (2413MHz ~ 2461 MHz)

Caution

1. The max operating of the EUT is 45°C. and shouldn't be lower than -10°C.
2. The device complies with RF specifications when the device used at 0mm from your body.
3. Declaration of Conformity.

We, Xiamen Huoshiquan Import & Export CO., LTD hereby, declare that the essential requirements compliance with the Directive 2014/53/EU, the RoHS Directive 2011/65/EU and Safety Directive 2009/48/EC have been fully fulfilled on our product with indication below:

Product Name: REMOTE CONTROL MODEL/RADIO CONTROLLED
Model/Mark : HS110G/HOLYSTONE

The Statement of compliance is available at the following address:

http://www.holystone.com/docs/HS110G_EU_DOC.pdf

This product can be used across EU member states.

MANUFACTURER INFORMATION

Manufactured by

Xiamen Huoshiquan Import & Export CO., LTD

Room 703, No. 813-2 Xiahe Road, Siming District, XIAMEN, China

+1 (855) 888-6699



Made in China