

DRONE

(EN)

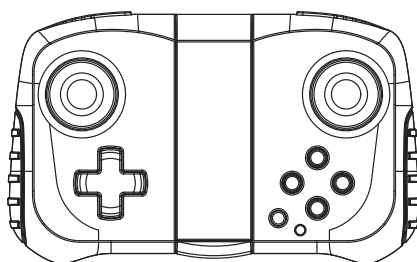
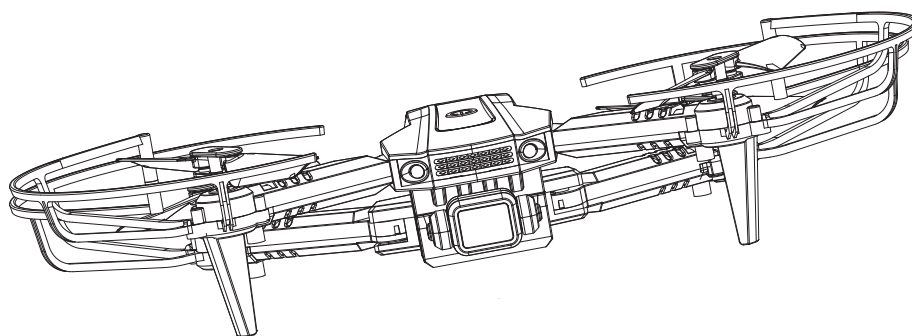

Contents

Disclaimer & Safety Guidelines	1
Maintenance and Care	1
Video Tutorials	2
Package Contents	2
Specification	2
Drone Diagram	3
Controller Diagram & Usage of Trim Buttons	3
Battery Installation - Controller	4
Charge the Battery	4
Unfold the Drone and Controller	4
Propeller Guard Installation	5
Propeller Replace Guide	5
Flight Instruction	6
Battery Installation - Drone	7
Linking Controller with the Drone	7
Calibrating the Drone	7
One Key Auto Take-off /Land	8
Emergency Stop	8
Mode of High/Medium/Low Speed	8
3D Flips	9
Headless Mode	9
Download APP and Connect to WIFI	10
APP Operation Panel	11
Trouble Shooting	12

DISCLAIMER & SAFETY GUIDELINES

Please read the disclaimer carefully before using this product. By using it, you hereby agree to this disclaimer and signify that you have read them fully.

1.FLIGHT ENVIRONMENT:



2.DO NOT fly above or near obstacles,crowds,cars,open water,public road,high voltage power lines, trees or airport.

3.DO NOT fly the drone in the magnetic interference area,radio interference area, and government regulated no-fly zones.



4.DO NOT use this product in severe environments such as rain,snow,fog and wind, etc.



5.Please always stay away from the rotating propellers and motors.

6.Always keep small parts and electrical parts out of the reach of children.

7.The charger is not a toy. Only use the original charger provided.

8.Battery charging should be done in a location out of reach of children. When charging it must be kept away from flammable materials such as bed,carpet,wood floors etc.,

9.DO NOT reverse polarity or puncture batteries. DO NOT store the batteries near any heat source.

10.Dispose of the drone and batteries in accordance with local regulations. DO NOT treat it as household waste.

HASAKEE accepts no liability for damage, injury or any legal responsibility incurred directly or indirectly from the use of this product. The user shall observe safe and lawful practices including, but not limited to, those set forth in these Safety Guidelines. HASAKEE reserves the right to update this user manual.

MAINTENANCE AND CARE

1:Check thoroughly (take note the propellers) everytime after a crash or violent impact.

2:Before the first fly, learn how to apply the "Emergency Stop" function, which is in page 8 of this manual.

3: Do not charge the battery if it is hot. Let it cool down first.

4: If you do not plan to use your drone for an extended period of time, remove the batteries from the controller to avoid battery leakage, which may damage the controller.

5: Keep the drone and the controller in a location where is cool and dry, and avoid long time exposure to direct sunlight.

6: Please give your drone minutes cool down time after each flight, to increase the durability of the drone.

Video Tutorial





Please find the following url or scan code to watch our Q10 drone tutorial video on YOUTUBE.

<https://youtu.be/jY93YprK72I>
<https://youtu.be/UJSpqybfMH0>
<https://youtu.be/pdky0hqLbPA>

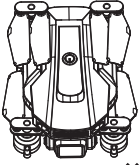
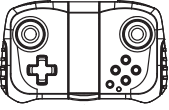

Subscribe us on YouTube

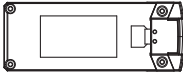
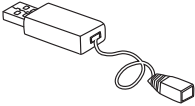
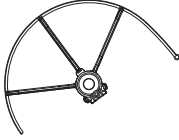
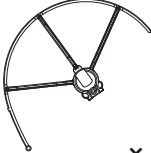
Package Contents

 x 1	 x 1	 x 4	 x 2
Drone	Controller (Batteries Not Included)	Spare Propellers (A x 2, B x 2)	3.7V 550mAh Lipo Battery
 x 2	 x 2	 x 2	 x 1
USB Charger	Propeller Guard (for rear propellers)	Propeller Guard (for front propellers)	Screwdriver

Specifications

Max Flight Distance: 164 feet/ 50m (**outdoors and unobstructed**)
Transmission Distance: About 98 feet / 30m (**outdoors and unobstructed**)
Flight Time: About 9 mins
Charging Time: About 70 mins
Photo/Video Resolution: 1280 x 720P (store on mobile phone)
Mobile APP Requirement: Android 5.1 and later,
IOS 9.0 and later

Drone Diagram

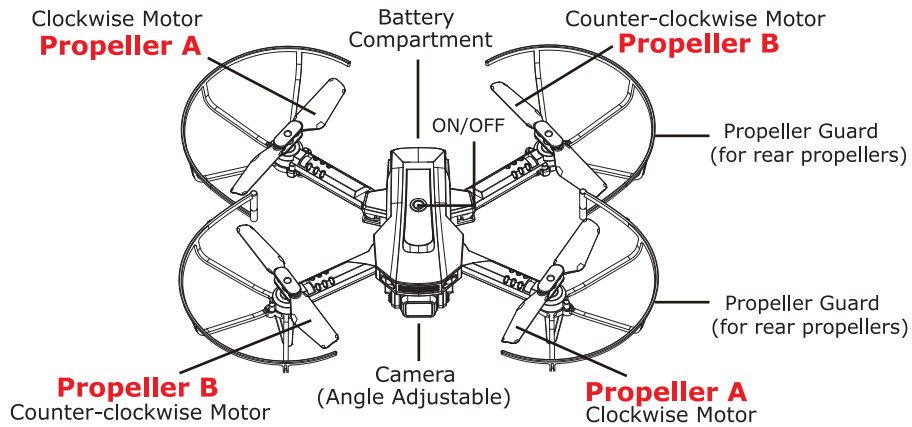

Controller Diagram & Usage of Trim Buttons

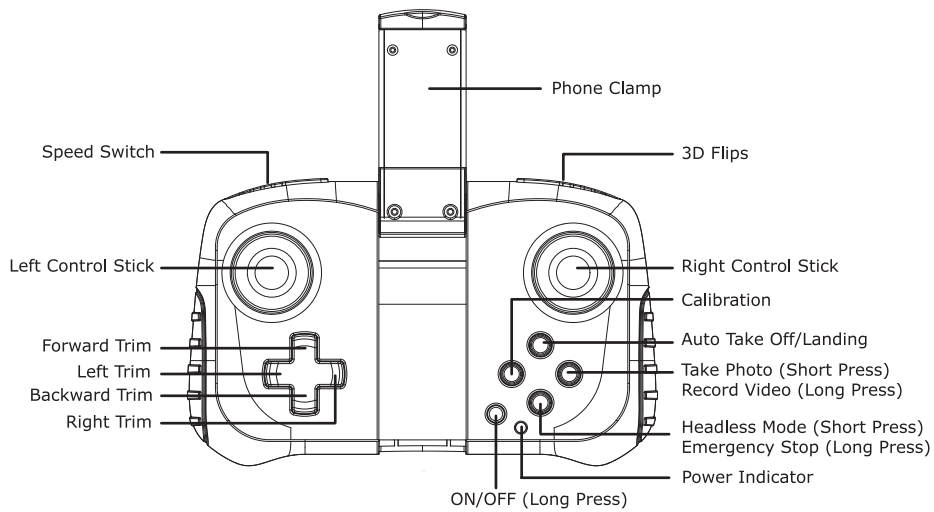

Left/Right/Forward/Backward Trimmer: If the drone drifts during flight, Press it to correct. **i.e.:** trim right if it drifts left. trim forward if it drifts backward. (It will only trim a bit when press once. Press more times to adjust until the drone stays oriented at the control.)

Battery Installation - Controller

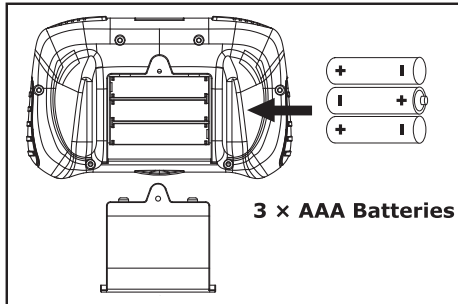

Note: When the remote controller continuously emits the sound of DI DI DI, it may be an alarm showing it is running out of battery, please replace the battery of the remote controller.

Charge the Battery

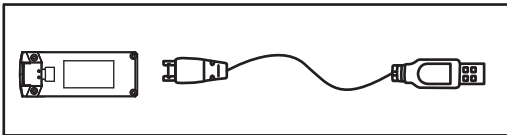

Important Note:

- * When the drone battery runs low, the indicator lights on the drone will blink continuously. The drone will land automatically after about 30 seconds.
- * Plug the USB charging cable into a USB charging port. Power output of 5V 0.5-2A must be used for safe charging.
- * Please always use the USB cables provided.
- * Charging: red light turn on
- * Charge Complete: green light turn on.
- * Charging Time (Full Charge): about 70 mins.
- * Flight Time: About 9 mins.

Unfold the Drone and Controller

1: Unfold the front arms, then the rear arms.

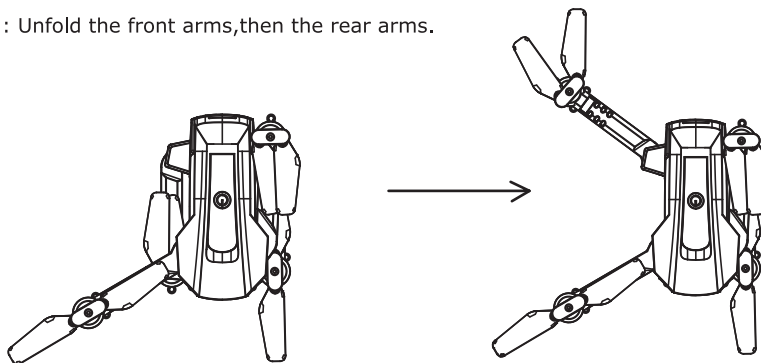

2. Unfold the phone clamp

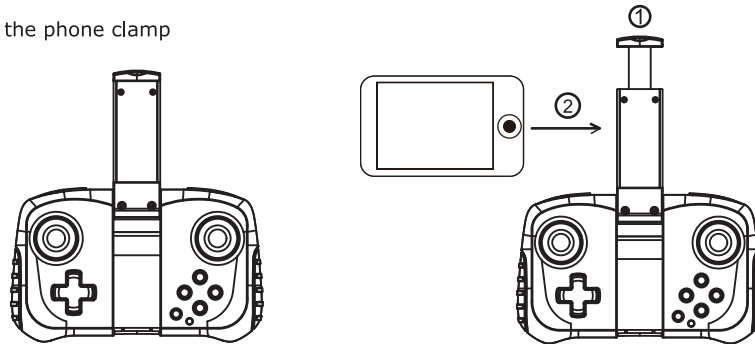

Install the Propeller Guards

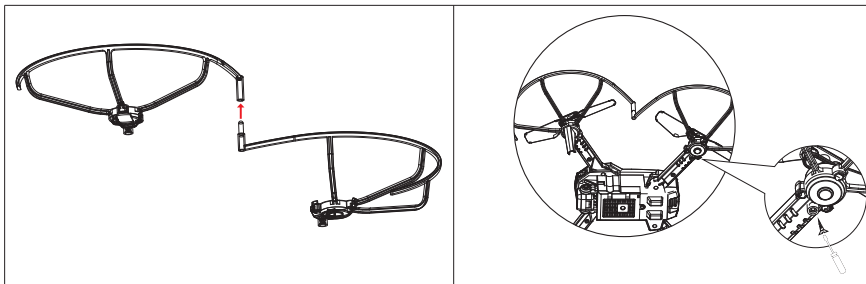

1. Connect two guards.
2. Install the guard to the two-foot stands (one to the front stand, one to the rear stand).
3. Tighten the screws or just press down.

Propeller Installation

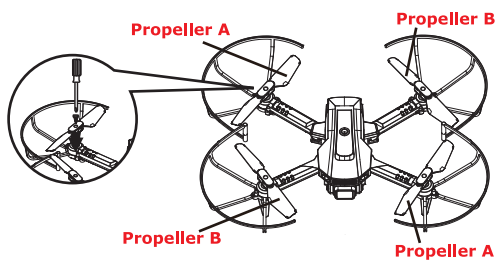

1. Loosen the screw to remove the propeller.
2. Fit the spare propeller into the drone.
3. Tighten the screws.

IMPORTANT NOTE: Every propeller has indicated alphabet A and B. Please install the propellers in correspondence with propeller A and propeller B as shown above. Otherwise the drone will fail to take off.

Tip: If the drone flying not stable after crashed or dropped. Please replace all damaged propellers.

Flight Instruction

Important note: For beginners, we would recommend the tail of the drone to face towards the pilot, so can better recognise the flight orientation and make operation easier.

Elevation

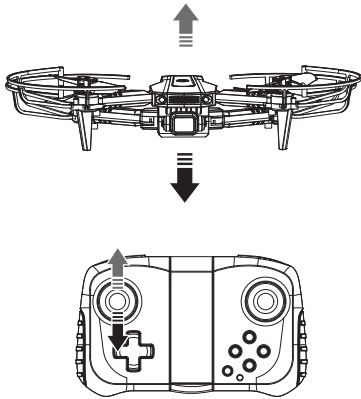

Ascend: Push up the left joystick
Descend: Pull down the left joystick

Forward and Backward

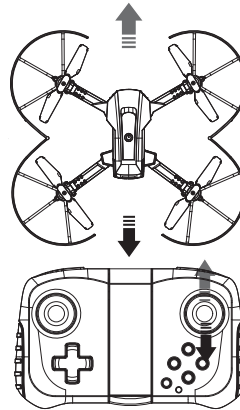

Forward: Push up the right joystick
Backward: Pull down the right joystick

Turning

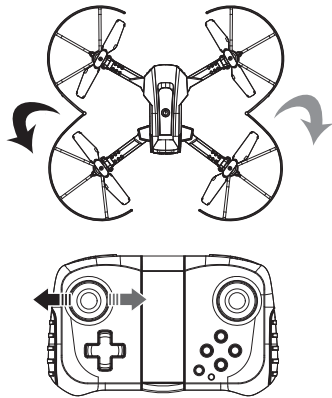

Turn Right: Push the left joystick to the right
Turn Left: Push the left joystick to the left

Sideways

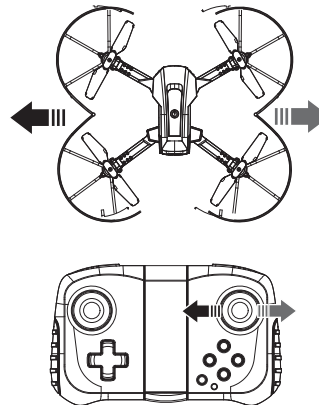

Fly to the Right: Push the right joystick to the right
Fly to the Left: Push the right joystick to the left

Battery Installation - Drone

Install the battery into the drone after it's fully charged.
Please push the battery to the end.
Long press the ON /OFF button to start.

Note: You may refer to our tutorial video for reference.

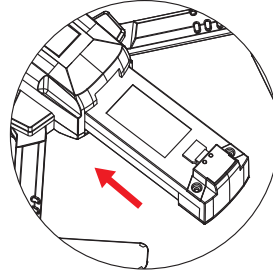

Linking Controller with the Drone

1. Turn on the drone first, then place it on a flat surface with the head forward. (the LEDs on the drone flash).
2. Turning on the controller. The controller will emit "DI DI" sound when turning on. The LED of the drone will go from flashing to solid, indicating that the controller and the drone is now paired.

Important Note:

1: Please make sure that the drone is placed on leveled surface otherwise it will fail to pair with the controller.

2: Please ensure the power of the drone has been turned on before turning on the controller. Otherwise it cannot be paired successfully.

3: If the drone keep blinking and fail to take off after powering on the controller, it means it's under low battery. Please charge it.

4: If fails to pair, please turn off the drone and the controller, and repeat steps.

Calibrating the Drone

Press the calibration button and the indicator on the drone will start flashing. Wait until the indicator stops flashing. It is now completed.

Note: If the drone flying not stable,
Please land the drone on level surface
and calibrate it.

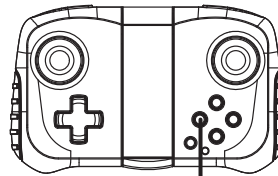

Calibration

One Key Auto Take-off / Land

TAKE OFF: After the linking and calibration, Press this button and the drone will start taking off and hovering in the air.

LAND: While in the air, press the same button and the drone will land automatically.

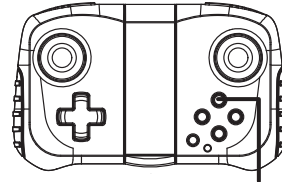

Auto Take off / landing

Note: Press the One Key Take-off button, the drone will fly up and hover at about 1.5 meters height. Please place the drone on the flat surface with enough climbing space before taking off.

Emergency Stop

In an event of an emergency where the drone needs to be stopped immediately, **LONG PRESS** the button and the drone will stop immediately.

Note: When using Emergency Stop function, it will cause the drone in the air to fall from the sky.

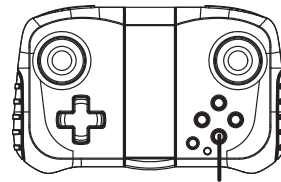

Emergency Stop (Long Press)

Mode of High/Medium/Low Speed

By default, the drone is set at low speed level. To speed up, press the button "Speed Switch" on the controller, it will emit "beep beep" sound, indicating it is at medium speed level. Press again and it will emit "beep beep beep" - High Speed Level.

Speed Switch

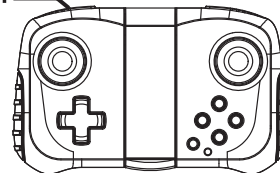

3D Flips

3D Flips: When the drone is flying in the air, press the button and a “beep” will be heard, quickly turn the right joystick to either directions and the drone will perform a 360 degrees flip towards that direction.

Note:

When the LED light keep flashing, it means the drone is under low battery mode. 3D Flip will **NOT** be performed by the drone.

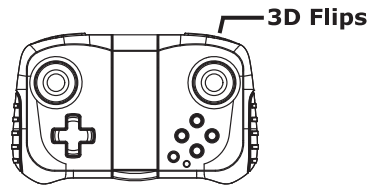

Headless Mode

Prerequisite: Before entering the Headless Mode, the drone is required to be calibrated.

1. Place the drone on a flat level surface, let the head of the drone face forwards, and the tail of the drone face towards the pilot, then calibrate the drone.
2. Press the Headless Mode button, the light of the drone will start flashing, meaning the drone is entering into Headless Mode.
3. Now you should be able to operate your drone under Headless Mode. To exit, press the Headless Mode button again, it will emit a beep sound, showing it has been exited.

Important Note: When calibrating the drone, ensure the head of the drone is facing forward, and tail is facing towards the pilot. This can help you better understand the headless mode. Because Headless Mode is set according to the direction of the drone while calibrating.

Under Headless Mode, if the direction of the drone is inaccurate, please land it and repeat step 1 and 2 to start again.

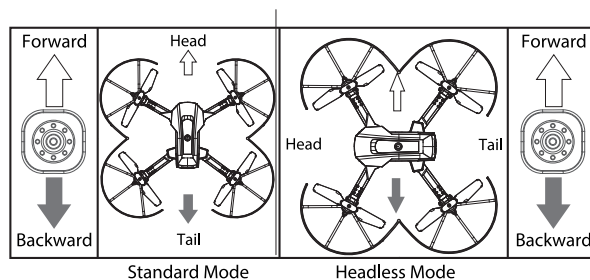

Download APP and Connect to WIFI

1. Please search "HASAKEE Q10" or scan the QR code to download the APP.



HASAKEE Q10



Available on the
APP store



Available on the
Google play

✓ HASAKEE-Q10-****





















2. Go to the wifi setting of your smart phone and connect to the wifi "HASAKEE-Q10-XXXX"
3. Launch the "HASAKEE Q10" APP and tap "start".

Important Note:



- 1) Please make sure that "HASAKEE-Q10-XXXX" WIFI is only connected to one smart phone.
- 2) If you fails to see the First Person View(FPV) after clicking "start" in the APP, it may because the app has been shielded by the smart phone. Please find the solutions as below:
 - 1:Check "HASAKEE Q10" APP setting, make sure "WLAN & Cellular Data" has been selected.
 - 2:Go to phone setting - turn off WI-FI - Turn on "Cellular Data" - Open the APP - A window will pop up - select "YES"
 - 3:Re-install the APP.
 - 4:Use another smart phone (ios/android).

APP Operation Panel





 Take Photo	 Calibration	 3D Flips
 Record Video	 Special Effects	 Voice Control
 Media Gallery	 Flip Image	 VR Mode
 ON/OFF	 More	 Take Off
 Unlock/Lock	 Gravity Sensor	 Landing
 Speed Switch	 Gesture Control	 Emergency Stop
 Headless Mode	 Trajectory Flight	

How to control the drone with the APP instead of remote controller?



Turn on the drone - Connect wifi "HASAKEE-Q10-XXXX" - Open the APP and click "Start" - Click  icon (icon  light up) - Click  icon to start the flight.

Click  icon (Trajectory Flight) to direct your drone's flight path by simply draw a flight route on the screen.

Click  icon (Voice Control): fly,land,left,right,forward,backward.(only support English)

Click  icon (Gravity Sensor) to control your drone's flight path by shifting your phone. For example: shift your phone leftwards, the drone will fly towards the leftside immediately.

Click  icon (Gesture Control) and make specific gesture within the sight range of camera, the drone will execute commands of taking photo /video.

i.e.:  - take photo  - record video (repeat the same action to stop shooting).

TROUBLESHOOTING

Problems	Reasons	Solutions
The light on the drone are flashing and the drone is not responding.	<ol style="list-style-type: none"> 1.Insufficient battery power. 2.Controller is NOT connected to the drone. 3.Unbalanced position. 4.Cannot pair due to the drone being powered on for a long time. 	<ol style="list-style-type: none"> 1.Fully charge the battery. 2.Turn off the drone and controller.Reconnect them by turning on the drone first then the controller. 3.Place the drone on a horizontal flat surface and reconnect them. 4.Turn off the drone and controller.Reconnect them by turning on the drone first then the controller.
The propellers spin but doesn't take off.	<ol style="list-style-type: none"> 1.Insufficient battery power. 2.Propellers NOT installed correctly. 3.Damage propellers. 4.Something being caught in the propellers or gears. 	<ol style="list-style-type: none"> 1.Fully charge the battery. 2.Check the propellers installation (A to A,B to B) 3.Replace new propellers. 4.Clear gears and propellers.
The drone doesn't fly properly after a crash.	<ol style="list-style-type: none"> 1.Propellers NOT installed correctly; 2.Damaged propellers; 3.The balance of gyro is confused; 4.Propellers have hit the Blade Guard. 5. Motor burnt out 	<ol style="list-style-type: none"> 1.Check the propellers installation (A to A,B to B) 2.Replace new propellers. 3.Calibrate the drone or press trim button to fine tune the direction. 4.Make sure blades work well. 5.Replace motors.

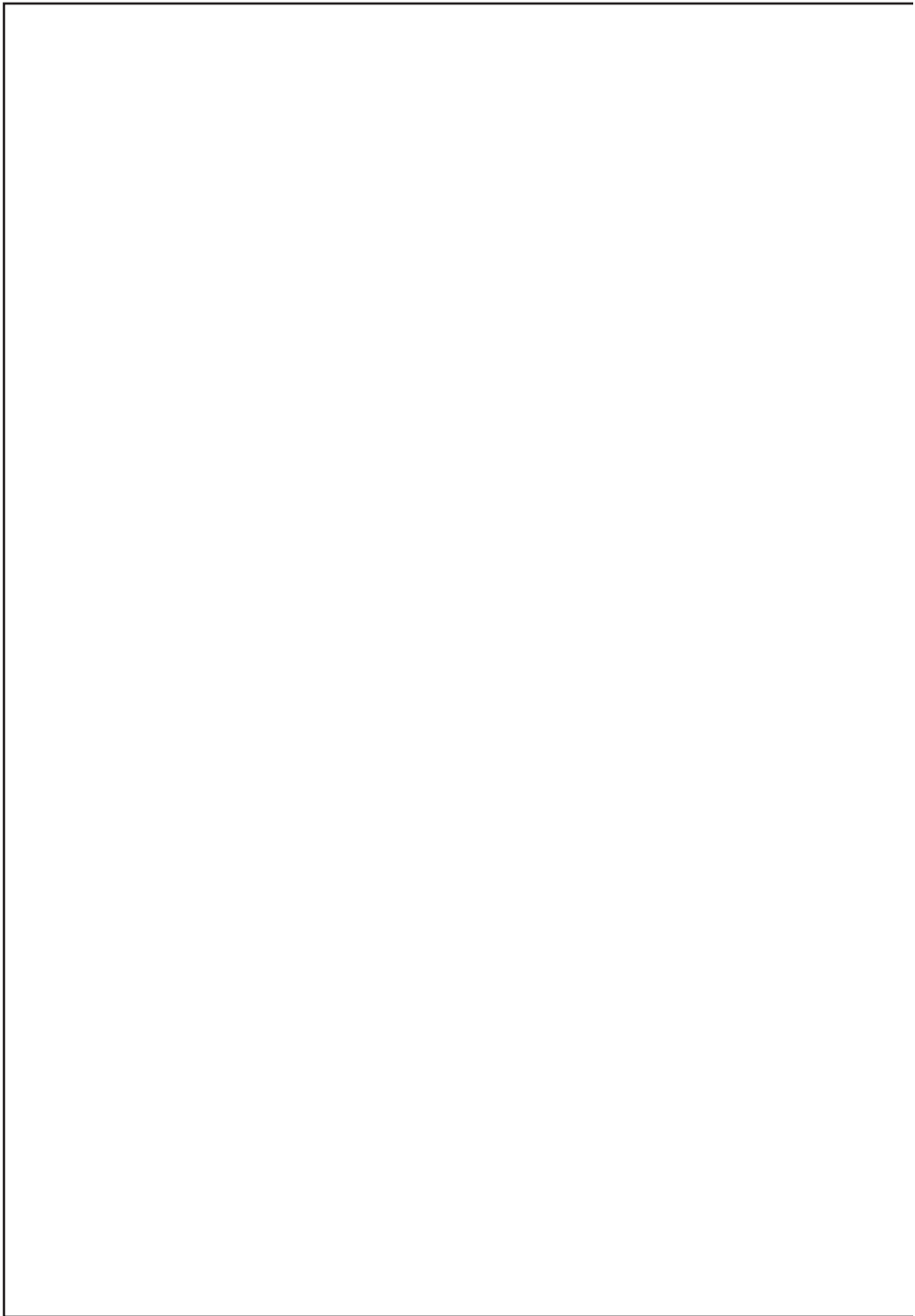

Contact Us

HASAKEE is committed to leave all our customers best products and services. We value each of our customers and appreciate your suggestions and opinions. Please feel free to contact us:



support_us@hasakee.com

support_eu@hasakee.com



<https://www.facebook.com/hasakeetoy/>



Subscribe us on YouTube

FCC Compliance

This device complies with Part 15 of the FCC Rules. Operation is subject to the following two conditions: (1) this device may not cause harmful interference, and (2) this device must accept any interference received, including interference that may cause undesired operation.

Note: This equipment has been tested and found to comply with the limits for a Class B digital device, pursuant to Part 15 of the FCC Rules. These limits are designed to provide reasonable protection against harmful interference in a residential installation. This equipment generates, uses and can radiate radio frequency energy and, if not installed and used in accordance with the instructions, may cause harmful interference to radio communications. However, there is no guarantee that interference will not occur in a particular installation. If this equipment does cause harmful interference to radio or television reception, which can be determined by turning the equipment off and on, the user is encouraged to try to correct the interference by one or more of the following measures:

- Reorient or relocate the receiving antenna.
- Increase the separation between the equipment and receiver.
- Connect the equipment into an outlet on a circuit different from that to which the receiver is connected.
- Consult the dealer or an experienced radio/TV technician for help.

Caution: changes or modifications not expressly approved by the party responsible for compliance could void the user's authority to operate the equipment.

CAUTION

Risk of explosion if battery is replaced by all incorrect type.
Dispose of used batteries according to the instructions



The symbol indicates DC voltage

RECYCLING

This product bears the selective sorting symbol for waste electrical and electronic equipment (WEEE). This means that this product must be handled pursuant to European directive 2012/19/EU in order to be recycled or dismantled to minimize its impact on the environment. User has the choice to give his product to a competent recycling organization or to the retailer when he buys a new electrical or electronic equipment.



BATTERY MUST BE RECYCLED OR DISPOSED OF PROPERLY

