



## Propel Flex 2.0 Drone Manual

[Home](#) » [Propel](#) » Propel Flex 2.0 Drone Manual

*Propel Flex 2.0*  
*Drone Manual*

# FLEX 2.0™

Compact Folding Drone with HD Camera



### INSTRUCTION BOOKLET

**WARNING:** Never leave product charging unattended for extended periods of time. Always disconnect the battery from charger immediately after the battery is fully charged. Please refer to enclosed safety instructions.

**Contents** [ [hide](#) ]

- 1 PACKAGE CONTAINS
- 2 FEATURES
- 3 REMOTE CONTROL BATTERY INSTALLATION
- 4 CHARGING THE FLEX 2.0™ LI-POLY BATTERY
- 5 INSTALL THE AIRCRAFT BATTERY
- 6 HOW TO EXPAND AND FOLD YOUR FLEX 2.0™
- 7 FLEX 2.0™ DIAGRAM
- 8 CONTROLLER DIAGRAM
- 9 FLIGHT PREPARATION
- 10 SYNCING YOUR FLEX 2.0™
- 11 NOW YOU ARE READY TO FLY!
- 12 RECOGNIZING THE FRONT & REAR OF THE FLEX 2.0™
- 13 STARTING/STOPPING THE ROTORS
- 14 MANUAL START/STOP
- 15 AUTO START/LAND
- 16 SPEED SELECT BUTTON
- 17 FLIGHT CONTROL
- 18 FLIGHT PRACTICE
- 19 ADJUSTING THE TRIM
- 20 CALIBRATING THE FLEX 2.0™
- 21 HOW TO PERFORM 360° STUNT ROLLS
- 22 LIVE VIDEO STREAMING SETUP
- 23 PROPEL FLEX 2.0™ WiFi APP INSTALLATION
- 24 PAIRING FLEX 2.0™ TO YOUR COMPATIBLE DEVICE
- 25 QUICK START
- 26 DETAILED APP OVERVIEW
- 27 TROUBLESHOOTING YOUR FLEX 2.0™
- 28 REPLACING THE PROPELLER BLADES
- 29 FLEX 2.0™ WARNING:
- 30 BATTERY WARNINGS
  - 30.1 RECHARGEABLE BATTERY:
  - 30.2 CONTROLLER BATTERIES:
- 31 CARE AND MAINTENANCE
- 32 Limited 90-Day Warranty
  - 32.1 REPAIR/REPLACE PRODUCT
  - 32.2 IMPORTANT NOTICE:
  - 32.3 PREPARATION FOR SHIPPING YOUR PRODUCT:
  - 32.4 FCC Part 15 C Notice
- 33 Related Posts

**PACKAGE CONTAINS**



FLEX 2.0™



2.4G Wireless Controller



Spare Parts



USB Charger



Phone Holder



Battery



Instruction Manual

Colors and styles may vary slightly.

PROPEL

## FEATURES

- Compact fold-in design allows for easy portability
- Air pressure sensor locks flight altitude for stable video footage
- Takes video and still pictures with on board hd camera
- 6 axis gyro for extremely stable flight and maneuverability
- 3 speed settings for suit beginner to more advanced pilots
- Wide range digital radio allows flight range up to 91.44 m (300 ft)

## REMOTE CONTROL BATTERY INSTALLATION

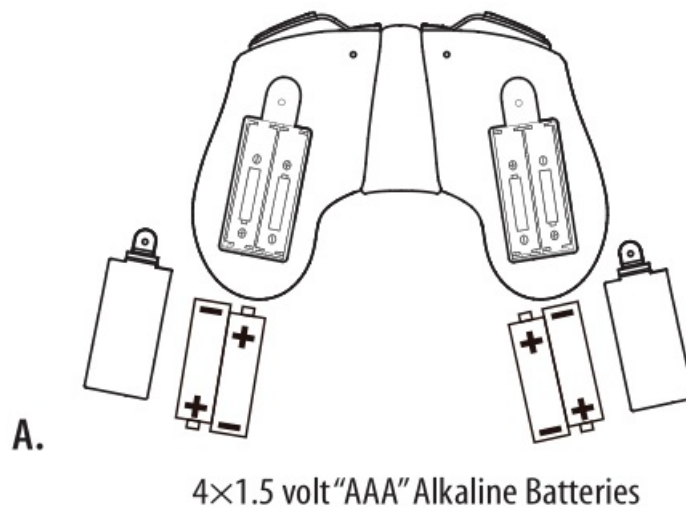

1. Unscrew and remove the battery cover from the back of the controller.
2. Install 4 fresh "AAA" alkaline batteries into the controller as shown in diagram A. Replace the battery cover.
3. Turn over the controller and push the power button up. If the power indicator turns on you have installed your batteries properly.

## CHARGING THE FLEX 2.0™ LI-POLY BATTERY

1. Insert the battery to the charger as shown (see diagram B).
2. Connect the USB end of the cable to your computers USB port or a USB wall charger (see diagram C).
3. Connect the battery to the socket on the USB charging cable, the red LED indicator will light off. When charging is completed, the red LED indicator will light on again.
4. Average charging time is approximately 130-140 minutes ( via 5.0V 2A USB wall charger). A fully charged FLEX 2.0™ can fly for 8-10 minutes depending on environment and user input.

**NOTE:** You may purchase additional batteries and wall chargers at [www.amaxbrands.com](http://www.amaxbrands.com)

**IMPORTANT:** ALWAYS REMEMBER TO UNPLUG YOUR CHARGING CORD WHEN NOT IN USE!

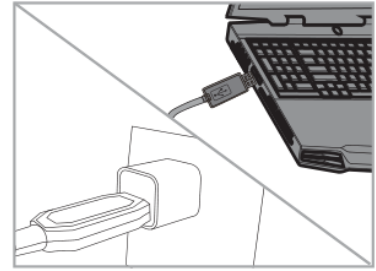
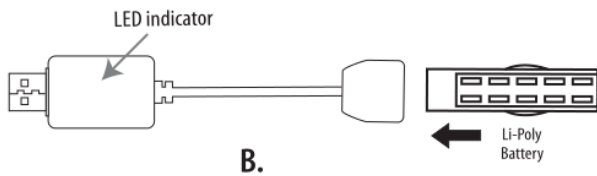

## INSTALL THE AIRCRAFT BATTERY

Put the battery into the battery compartment then lock the two ends with the battery locks.(see diagram D)

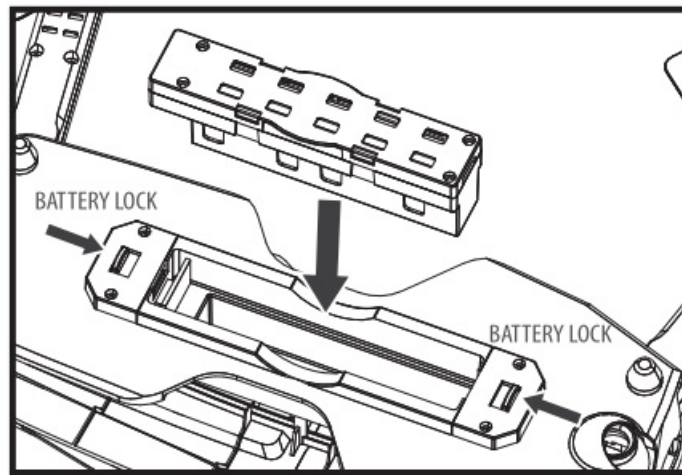

## HOW TO EXPAND AND FOLD YOUR FLEX 2.0™

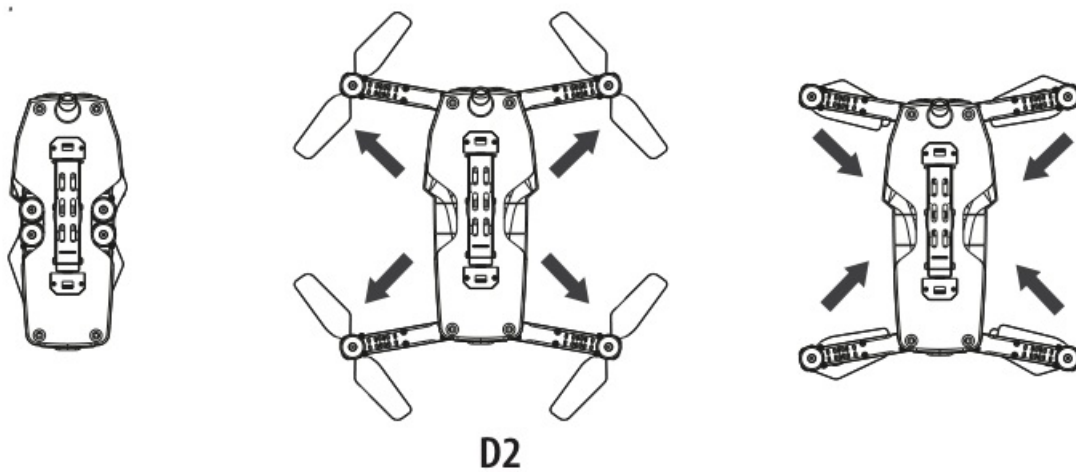

Before flying your FLEX 2.0™, you need to expand the foldable arms out. Turn your FLEX 2.0™ over, bottom side facing you, pull and expand the 4 arms as shown in the diagram below carefully. Make sure the arms are fully expanded to the position. After flying your FLEX 2.0™, it is recommended to fold all 4 arms back in. When expanding or folding your FLEX 2.0™, make sure to be gentle.( see diagram D2)

## FLEX 2.0™ DIAGRAM

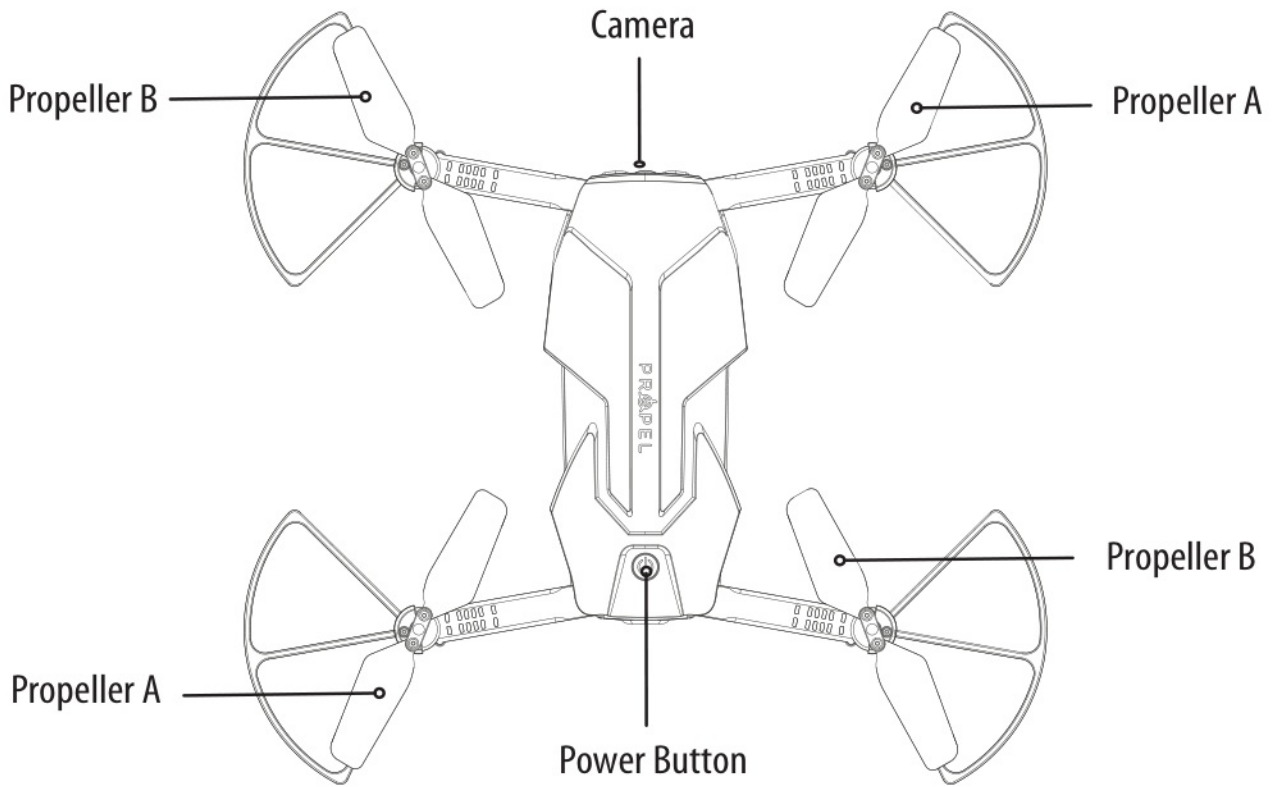

## CONTROLLER DIAGRAM

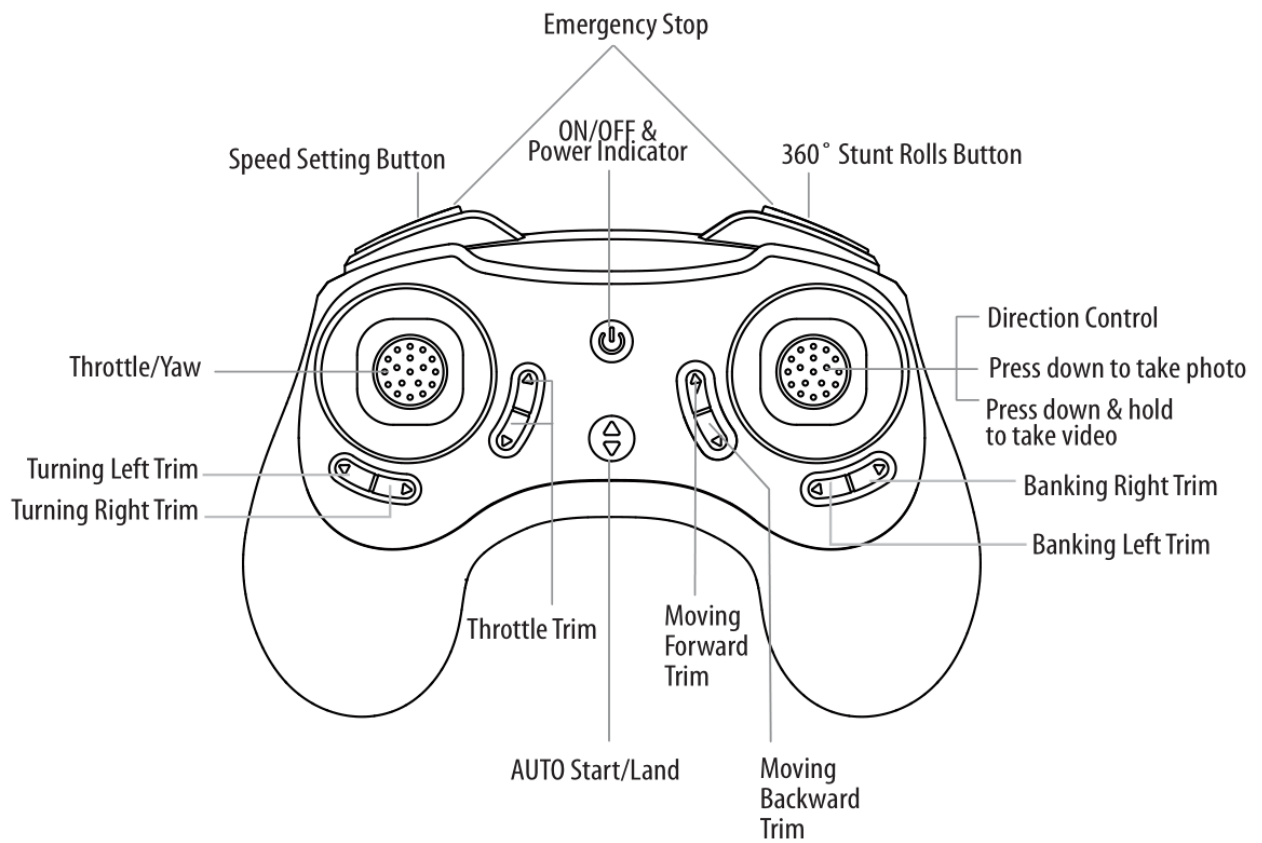

# WARNING

## DO NOT FLY YOUR FLEX 2.0™ IN FOUL WEATHER!



### FLIGHT PREPARATION

- Verify that there are 4 “AAA” batteries inside the remote control unit and the FLEX 2.0™ battery has been fully charged.
- Make sure to be in a large open space preferably a field or a park with an open radius of at least 60.96 m (200 ft).
- Make sure to start your drone on a clean flat level surface before take-off.
- **IMPORTANT!** Until you have experience in flying your FLEX 2.0™, it is not advised to use in any rate of wind. Pick a day with zero wind or extremely light wind condition when learning how to fly.

### SYNCING YOUR FLEX 2.0™

**Important!** When syncing your FLEX 2.0™ with the controller always make sure that the drone is on a flat level surface and that your digital trim settings are in the center position.

1. Before starting, make sure that the power on your controller is off and the battery is removed from the FLEX 2.0™. Make sure that there are no other 2.4G devices in the area.
  2. Insert the battery into the FLEX 2.0™ and set it down on a flat level surface. Push down the power button and hold for a few seconds (see diagram D1). The red and white LED lights on the drone should begin to flash rapidly.
  3. Quickly turn ON the remote and you will notice that the top red LED light on the face of the controller should also be flashing. The lights on the drone will flash slower.
  4. Push the throttle stick all the way up until it stops and then pull it back all the way down to the bottom (see diagram below). When pushing the stick up or pulling the stick down you should hear a high-pitched beep both ways. The indicating lights on the drone and controller will stop flashing and stay solid on. You have successfully synced your FLEX 2.0™ and are ready to fly. If this doesn't happen, repeat steps 1-4 again.
- **TIP 1:** Try not to leave too much time between putting your battery into the drone and turning on the controller or your syncing window will time-out.
  - **TIP 2:** Syncing your drone indoors or in the shade will make it easier to see the LED light indicators on both the controller and the drone.

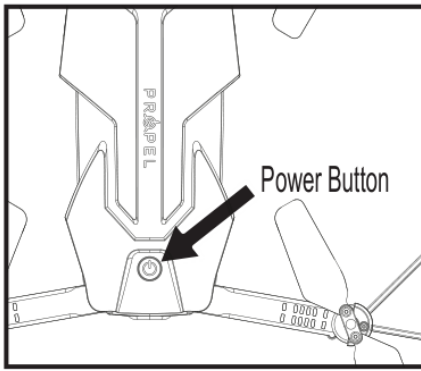

D1

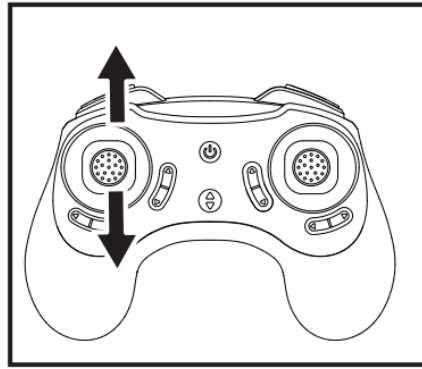

Move the control stick all the way up and all the way down, you should hear two beeps.

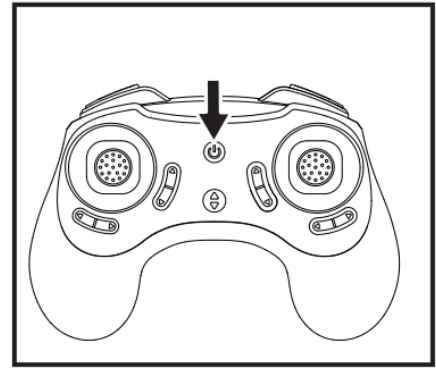

The flashing red LED light will become solid when you are synced.

## NOW YOU ARE READY TO FLY!

If you have successfully synced your FLEX 2.0™ to your controller as explained on page 4 you are now ready to fly. Before beginning to fly your drone you should familiarize yourself with how to start and stop the rotors, how to use your auto land feature and how the controls work so please carefully read and familiarize yourself with various control features explained in the next few pages. Once again as a beginner pilot you should learn how to control your drone in a large open field or park on a day with zero or very light wind. Do not try to fly your FLEX 2.0™ too high until you become a more experience pilot.

## RECOGNIZING THE FRONT & REAR OF THE FLEX 2.0™

Even though the FLEX 2.0™ has four rotors there is still a front or “forward” facing direction and “rear” or backwards facing direction. The front and forward facing direction of the FLEX 2.0™ is the side with two white lights. (see diagram E ). The rear and backward facing direction of the Quadro copter is the side with one red (see diagram E).

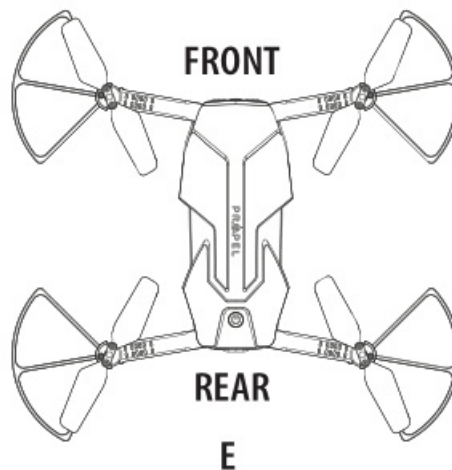

## STARTING/STOPPING THE ROTORS

Note: You can start/stop your FLEX 2.0™ manually or automatically. Please follow one of the steps below to operate accordingly. Make sure you have properly synced the FLEX 2.0™ and the power stays on.

### MANUAL START/STOP

- To start the rotors simply move the two control sticks both down and out (see diagram), hold until the rotors start spinning. Now release both sticks to the neutral position and push the throttle up to take off.

- To stop the rotors, after starting the rotor you can simply wait about 10 seconds, and it will stop automatically. Or move both sticks down and out again to stop immediately. After take off, you can simply pull the throttle all the way down and land.

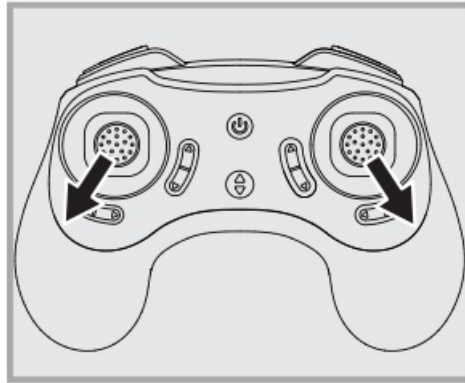

## AUTO START/LAND

The FLEX 2.0™ has an auto start/land feature which allows you to start/land automatically. Simply press the AUTO START / LAND button on the top of the controller and your FLEX 2.0™ will begin taking off/landing(see diagram below).

**NOTE:** You can still control the direction while auto starting/landing to avoid obstacles.

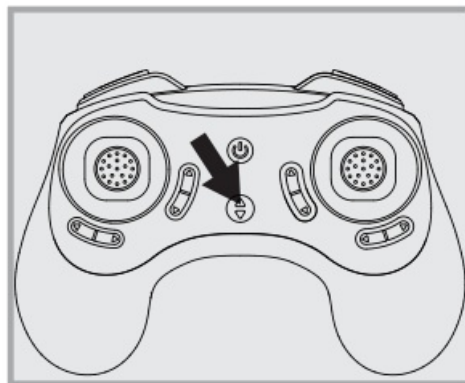

## SPEED SELECT BUTTON

The FLEX 2.0™ has 3 speed settings; 1 (SLOW), 2 (MEDIUM) and 3 (HIGH). The Default setting when you first turn on your FLEX 2.0™ is the 1 (SLOW) speed mode. To increase the speed simply trigger the speed setting button (see remote diagram on pg 3) You will hear beeping sound, 1 beeping sound indicates slow speed, 2 beeping sounds indicates medium speed and 3 beeping sounds indicate high speed. Speed settings can be set before flight or during the flight.

## FLIGHT CONTROL

Below is a list of basic flight functions for your long-range remote to control the FLEX 2.0™. While learning to fly your FLEX 2.0™ it is best to start in a large space with the drone facing away from you until you get used to the basic controls. As you master flying your FLEX 2.0™ you can move to more advanced maneuvering techniques. Practice makes perfect!



Move the left Throttle stick up to increase the propeller speed and the FLEX 2.0™ will accelerate and ascend.

Move the left Throttle stick down to decrease the propeller speed and the FLEX 2.0™ will decelerate and descend (see diagram I).

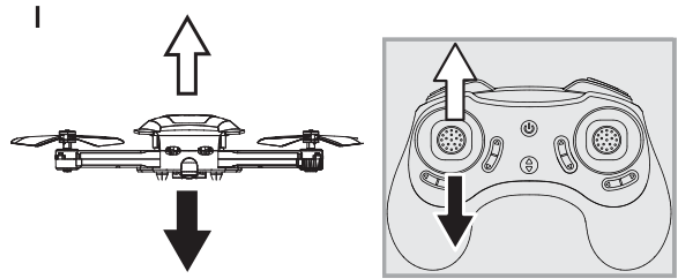

While in the air, move the left Throttle stick left and the FLEX 2.0™ will rotate left.

Move the left Throttle stick right and the FLEX 2.0™ will rotate right (see diagram J).

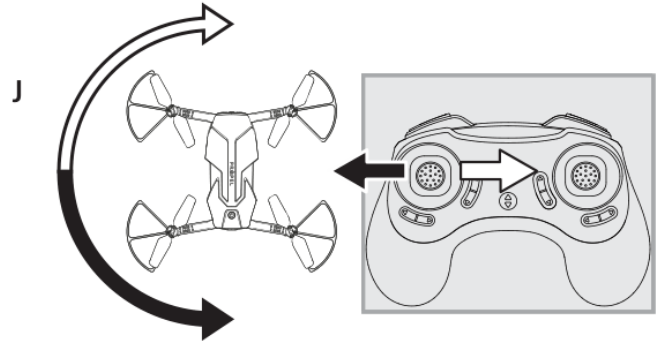

While in the air, move the right Direction Stick up and the FLEX 2.0™ will move forward.

Move the right Direction Control down and the FLEX 2.0™ will move backward (see diagram K).

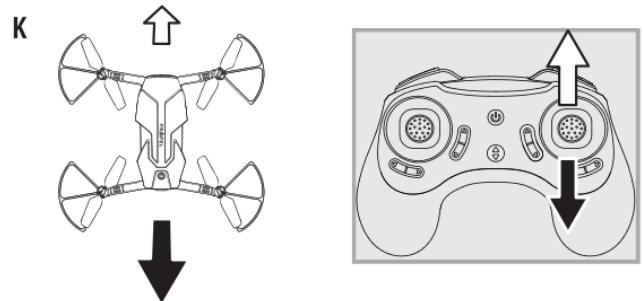

While in the air, move the right Direction Control left and the FLEX 2.0™ will bank to the left.

Move the right Direction Control right and the FLEX 2.0™ will bank to the right (see diagram L).

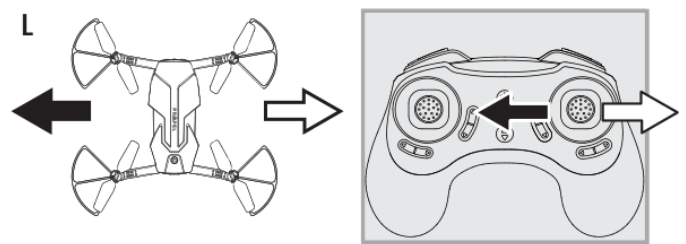

## FLIGHT PRACTICE

To master flying your aircraft try practicing the exercises shown below, start with simple vertical takeoffs, landings, and left/right turning and rotating. Once those are mastered, move on to square and cross maneuvers. Good luck and have fun!

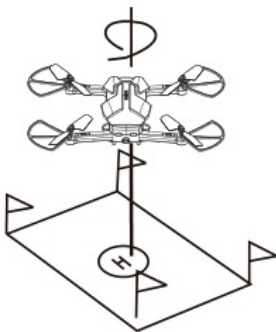

Fixed-Point Landing

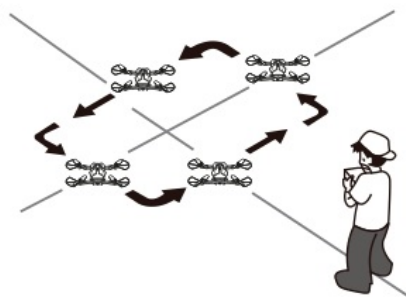

Square Pattern Maneuver

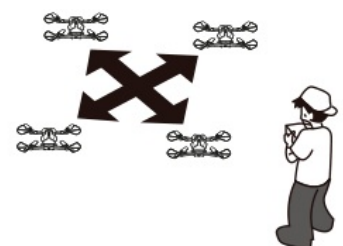

Cross Pattern Maneuver

## ADJUSTING THE TRIM

**NOTE:** The FLEX 2.0™ is already properly trimmed and calibrated right out of the box and should not require any trim adjustments before flying. Some more experienced pilots may want to adjust trim settings for their style of flying. After several crashes you may need to adjust trim settings for the FLEX 2.0™ to be more balanced.

### Forward/Backward Trim

- If your FLEX 2.0™ drifts forward while in the air, push and release the FORWARD/BACKWARD TRIM button downward repeatedly until the motion stops and proper flight is maintained (see diagram M).
- If your FLEX 2.0™ drifts backwards, push and release the FORWARD/BACKWARD TRIM button upward in the same manner until the problem is resolved.

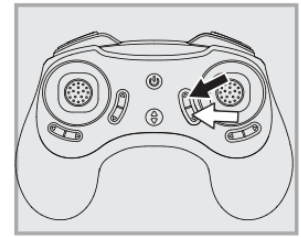
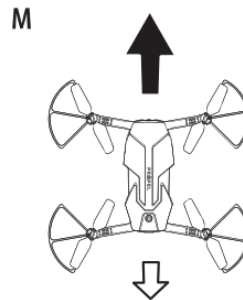

### Bank Right/Left Trim

- If your FLEX 2.0™ drifts / banks left while in the air, push and release the BANKS TRIM button to the right side repeatedly until the motion stops and proper flight is maintained (see diagram N).
- If your FLEX 2.0™ drifts right, push and release the BANKS TRIM button to left side in the same manner until the problem is resolved.

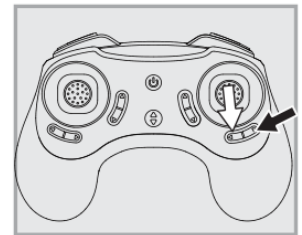
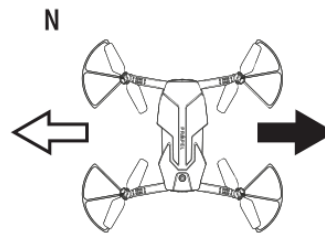

### Spin Left Trim

- If your FLEX 2.0™ spins left while in the air, push and release the LEFT/RIGHT TURN TRIM button to the right side repeatedly until the motion stops and proper flight is maintained (see diagram O).

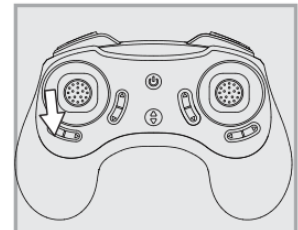
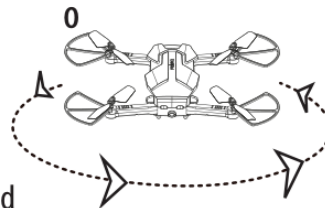

### Spin Right Trim

- If your FLEX 2.0™ spins right while in the air, push and release the LEFT/RIGHT TURN TRIM button to the left side until the problem is resolved (see diagram P).

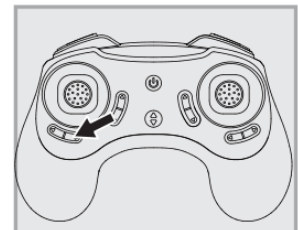
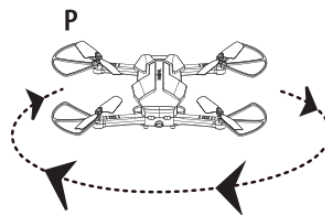

### Throttle Trim

- Release the Throttle to hovering your FLEX 2.0™ in the air, if your FLEX 2.0™ keep ascend, push and release the Throttle TRIM button downward repeatedly until the motion stops and proper flight is maintained (see diagram q).
- If your FLEX 2.0™ descend, push and release the Throttle TRIM button upward in the same manner until the problem is resolved.

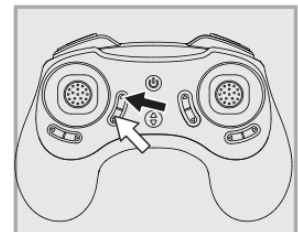
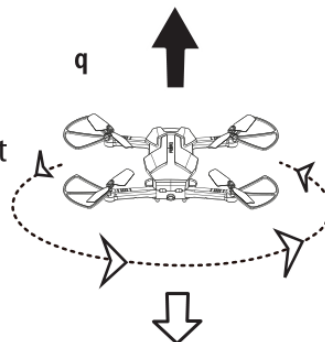

**EMERGENCY STOP:** press the “speed setting button” and “stunt button” simultaneously to stop the drone blade from spinning. Use it when you lose control of your drone.

**NOTE:** The use of the Trim buttons utilizes sounds. A single long Beep indicates the product is center trimmed. When there's no sound when press the trim means the product is trimmed to the maximum on a particular side.

## CALIBRATING THE FLEX 2.0™

**NOTE:** Your FLEX 2.0™ comes pre-calibrated out of the box so you are ready to fly. After several crashes and shocks to your gyro sensors, you may notice that your drone is drifting and can not hold its center position as well as it used to. This most likely means that you need to recalibrate your FLEX 2.0™. Please follow the simple instructions below.

1. Place the FLEX 2.0™ on a flat level surface
2. Make sure the FLEX 2.0™ is on and that the controller is synced (refer to syncing pg 4). Do not start the blades. Instead move both the throttles and control stick down and to the right corner and hold them there for 5 seconds(see diagram R). You will see the lights on the drone rapidly flash and stop. Once the lights stop flashing you have completed your calibration and are ready to fly!

**TROUBLE SHOOTING:** If you do not see the lights flash, first remove the battery from the drone then turn off your controller and start again. Always make sure to put your battery in first, then turn on your controller. Push the left throttle stick up all the way and then pull back down again. When you hear the beep the FLEX 2.0™ is synced to the controller and you are ready to calibrate.

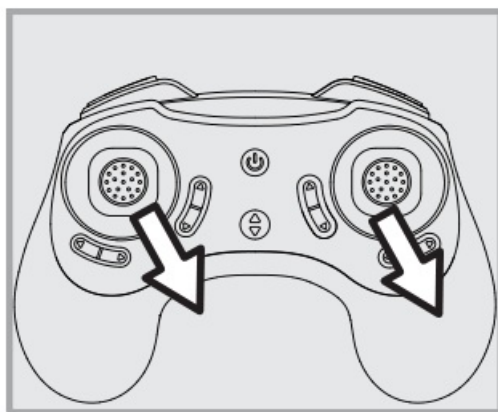

R

## HOW TO PERFORM 360° STUNT ROLLS

Performing 360° stunt rolls with the FLEX 2.0™ is as easy as 1-2-3:

1. Hover the FLEX 2.0™ in still position making sure that you have at least 5 feet of clearance above and below the Quadro copter. Set the speed settings to mode 2 or 3.
2. Press the 360 stunt button down and you will enter the stunt roll mode which is indicated by rapid beeping (see diagram S) sounds.
3. Determine which direction you want it to flip and quickly push the right control stick in the direction you want to flip your FLEX 2.0™ (see diagram T). You have 2 choices a) Right side roll, b) Left side roll.

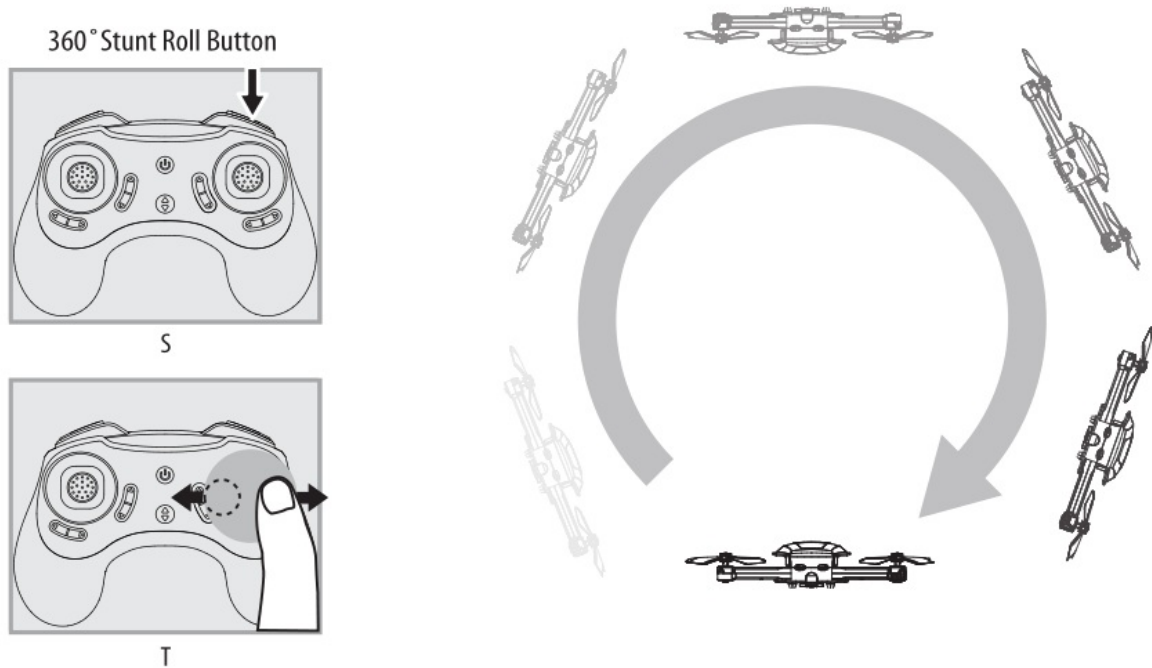

**NOTE:** To exit the stunt roll mode without flip, you can press the button again. The beeping sound will stop.

## LIVE VIDEO STREAMING SETUP

Your FLEX 2.0™ comes equipped with an onboard digital camera that takes both video and still photographs to your mobile devices.

## WHAT YOU WILL NEED TO GET STARTED USING YOUR CAMERA

1. One Apple or Android phone\* (not included)
2. Propel 1890 APP installed (app store or Android market available)

## PHONE HOLDER AND PHONE INSTALLATION

Insert the included phone holder hook (a) to the slots on the top of the controller properly, see the illustration below, When you install the phone holder correctly you can use it to hold your phone (see diagram U)

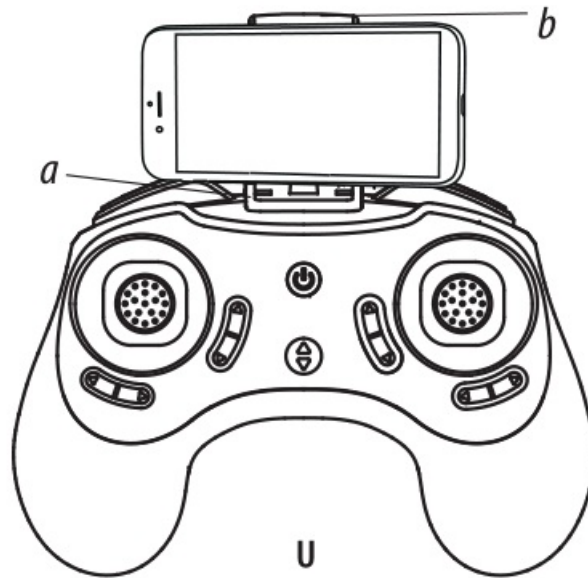

## PROPEL FLEX 2.0™ WiFi APP INSTALLATION

1. Make sure you are using a compatible Android™ or Apple® iOS device.
2. Make sure your device has access to the Internet.
3. For Apple® iOS devices, within the [App Store](#), search and select “Propel 1890”. Hit the Install button and the “Propel 1890” App should download and install automatically.
4. For Android™ OS devices, visit the [Google Play store](#) and search for “Propel 1890”. Selecting the “Propel 1890” App will download the App and automatically install it on your device.
5. After the “Propel 1890” App is installed, it should create an icon on your screen. Click the “Propel 1890” icon to run the App to make sure that it has installed correctly on your device. If not, please delete and repeat the process again.

## PAIRING FLEX 2.0™ TO YOUR COMPATIBLE DEVICE

1. After completely charging your FLEX 2.0™ battery, install the battery to your FLEX 2.0™ (refer to the user manual).
2. In the Settings menu of your device, locate the Wi-Fi option.
3. Turn ON the Wi-Fi option.
4. Select “Propel 1890” from the Wi-Fi list. The password is the 8 numbers that are attached to the Propel WiFi network. Enter the numbers to activate your account. Return to the Main Menu.





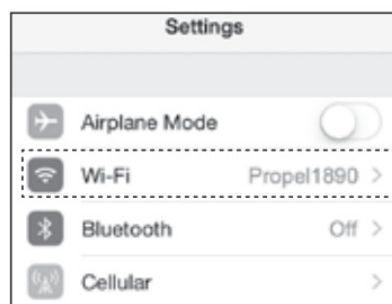

Settings



Propel1890

**Note:** Apple® devices require the use of iOS 7.0 or higher. ANDROID™ devices require the use of OS 4.2.2 or higher.

## QUICK START

1. After you install the App correctly and have paired to the drone successfully, you can open the “Propel 1890” App icon. Tap “START” on the bottom right hand side of the screen. You should see the real-time video streaming from your FLEX 2.0™ ‘s camera.
2. This App also allows you to control your FLEX 2.0™ by your mobile device. To activate the control sticks, tap the “ON” button at the top right hand side of the screen. This will switch the control from your traditional controller to your compatible device. Now click “” to start the motors. The control sticks will show up in the screen for your fly control and you can now use your device as a traditional controller. Or you can click “” to auto launch your FLEX 2.0™ in the air and then use your device as a traditional controller. Click this button again, your FLEX 2.0™ will automatically land on the floor.
3. You can click “” to take still pictures. Pictures will be stored into your mobile device. To record videos, you can click “”. There will be a timer start running on the screen, indicating the recording is on. The video footage will also be stored into your mobile device. Click “” you can see 2 folders, pictures and videos, you can find the pictures and videos you took with your FLEX 2.0™.

## DETAILED APP OVERVIEW

Please see images below for a detailed App overview. This overview is also available under the “HELP” icon in the home screen of the App

## HOME PAGE



## CONTROL STICKS

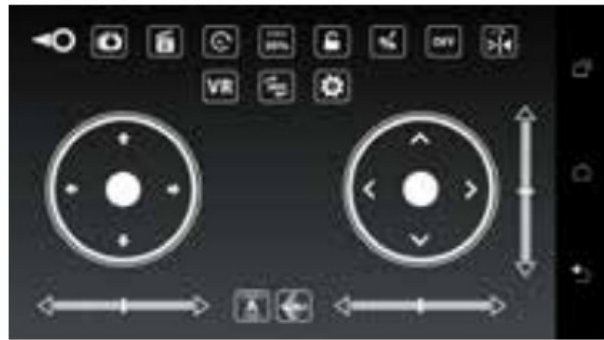

## HELP PAGE 1



## HELP PAGE 2



## HELP PAGE 3



## CAMERA SETTINGS



If you're still encountering difficulties please contact our customer service department at [www.amaxbrands.com](http://www.amaxbrands.com)

## TROUBLESHOOTING YOUR FLEX 2.0™

PROBLEM	POSSIBLE CAUSE	POSSIBLE SOLUTION
<b>No power</b>	1. Power switched off 2. Polarity is reversed  3. Batteries may be low or in need of charging	1. Switch the ON/OFF switch to ON 2. Make sure all batteries are installed correctly (see diagram A) 3. Replace batteries
<b>Aircraft not responding</b>	1. Remote is switched off 2. Battery power in remote is too weak 3. The remote is not properly synced 4. Out of control range	1. FLEX 2.0™ the ON/OFF FLEX 2.0™ to ON 2. Replace remote batteries 3. Re-sync the remote 4. Do not fly beyond 152.4 m (500 ft)
<b>Aircraft won't lift off</b>	1. Rotor speed too slow 2. Aircraft not fully charged 3. Obstruction of rotors	1. Push throttle lever forward 2. Recharge your FLEX 2.0™ 3. Check rotors for hair or other obstructions
<b>Aircraft spins, cannot be trimmed?</b>	Rotor deformation or bad motor	Replace the damaged rotor (You may need to consult with a Propel customer service personnel)
<b>Aircraft tilt to one direction</b>	Aircraft did not calibrate properly	Restart the aircraft and controller, properly calibrate it on a flat level surface
<b>Altitude hold height is not stable (up and down constantly)</b>	Aircraft vibrates too much	Check the propeller deformation

## REPLACING THE PROPELLER BLADES

Your FLEX 2.0™'s propeller system is a precision instrument that may need repair or replacement from time to time for optimal flight function. Crash landing at high-speed may cause damage to your FLEX 2.0™'s propellers.

1. The FLEX 2.0™ has four sets blades, two sets blades with indication number B & A on front, and two sets blades with indication number A & B on the rear (see the diagram V).
2. When replacing the propeller blades, make sure to match the indication markings on the blades.
3. Unscrew and take off the damaged blade.
4. Replace with new correct blade.



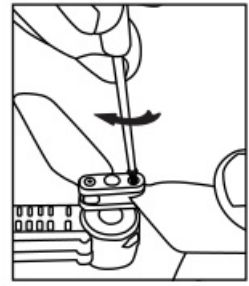
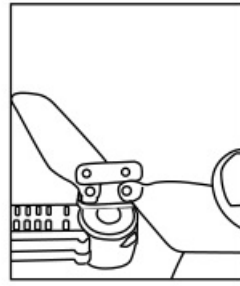
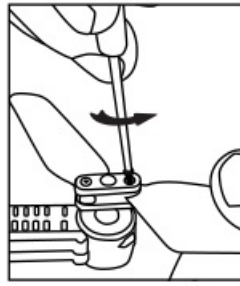
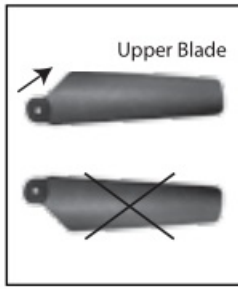

Blade Front Left = B  
Blade Front Right = A

---

Blade Back Left = A  
Blade Back Right = B

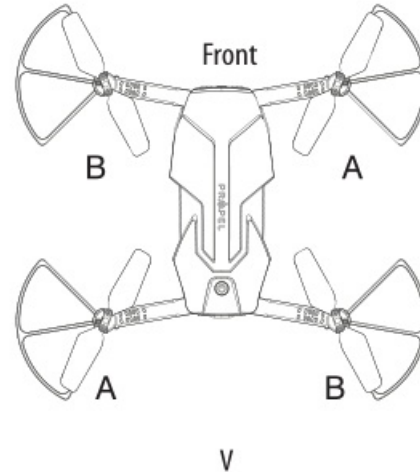

5. Click the blade guard into the place and then secure it with the screw.

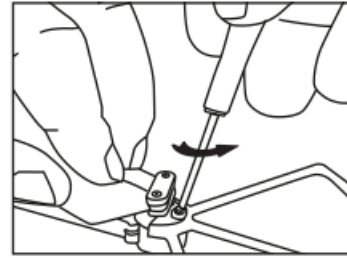
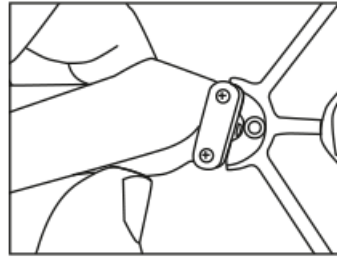
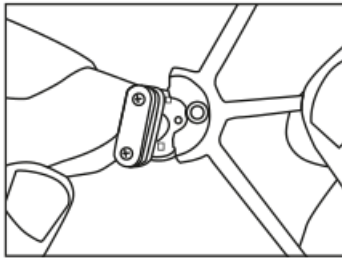

### FLEX 2.0™ WARNING:

The FLEX 2.0™ is designed for OUTDOOR use. The FLEX 2.0™'s blades revolve at high speeds and can cause damage to the user, spectators and animals. Stand away from the FLEX 2.0™ to reduce the risk of getting into the flight path. Warn spectators that you will be flying your FLEX 2.0™ so that they are aware of its position. Before flight, inspect the rotor blades to make certain that the blades are securely fastened to the FLEX 2.0™ .

### WARNING!

- Choking/Cutting Hazard. Small Parts/Sharp Rotor Blades.
- Keep hands, hair and loose clothing away from the propeller when the power FLEX 2.0™ is turned to the ON position.
- Turn off the transmitter and FLEX 2.0™ power FLEX 2.0™es when not in use.
- The included charger is built specifically for the FLEX 2.0™ Li-Poly battery. Do not use it to charge any other battery.
- New alkaline batteries are recommended for maximum performance.
- Parental supervision recommended when flying FLEX 2.0™ .

## **BATTERY WARNINGS**

### **RECHARGEABLE BATTERY:**

This FLEX 2.0™ uses a Li-Poly rechargeable battery. If battery no longer stays charged, dispose of battery properly according to local disposal requirements.

### **CONTROLLER BATTERIES:**

Remote control requires 4 “AAA” batteries (included).  
Please read the important battery safety warning below.

- Do not mix alkaline, standard (carbon-zinc) and rechargeable batteries (Nickel Metal Hydride).
- Do not mix old and new batteries.
- Non-rechargeable batteries are not to be recharged.
- Rechargeable batteries are to be removed from the item before being charged (if removable).
- Rechargeable batteries are only to be charged under adult supervision.
- Exhausted batteries should be removed immediately and must be recycled or disposed of properly according to state or local government ordinances and regulations.
- The supply terminals are not to be short-circuited.
- Only batteries of the same or equivalent type as recommended are to be used.
- Batteries are to be inserted with the correct polarity (see inside booklet for diagram).
- Do not dispose batteries in a fire – batteries may leak or explode.

## **CARE AND MAINTENANCE**

- Always remove the batteries from the wireless remote control when it is not being used for an extended period of time.
- To clean, gently wipe the remote control and FLEX 2.0™ with a clean damp cloth.
- Keep the toy away from direct heat or sunlight.
- Do not submerge the toy into water. This can damage the unit beyond repair.
- Parental guidance recommended when installing or replacing the batteries.

## **Limited 90-Day Warranty**

AMAX Group USA warrants to the original consumer that this product is free from any electrical or mechanical defects for a period of 90 DAYS from the date of purchase. If any such defect is discovered within the warranty period, AMAX Group USA will repair or replace the unit free of charge upon receipt of the unit, shipped postage prepaid and insured to our warranty center **ALONG WITH THE ORIGINAL RECEIPT** evidencing that the product was purchased from an approved AMAX retail partner and that the product is still within the 90 day warranty period. The warranty covers normal consumer use and does not cover damage that occurs in shipment or failure that results from alterations, accident, misuse, abuse, neglect, wear and tear, inadequate maintenance, commercial use or unreasonable use of the unit. Removal of any parts/components voids all warranties. This warranty does not cover cost of repairs made or attempted outside by third-party individuals or companies. Any applicable implied warranties, including warranties of merchantability and fitness, are hereby limited to 90 DAYS from the date of purchase. Consequential or incidental damages resulting from a breach of any applicable express or implied warranties are hereby excluded. Some states do not allow limitations on the

duration of implied warranties and do not allow exclusion of incidental or consequential damages, so the above limitations and exclusions in these instances may not apply.

## **REPAIR/REPLACE PRODUCT**

If your product begins to malfunction or stop working, immediately contact our warranty center (contact details listed below). If it is determined that a return is necessary, our warranty department will issue you an RMA number/form and an address to the nearest return center for shipping the product to us. When honoring the warranty, AMAX reserves the right to either repair, replace or refund the product.

### **IMPORTANT NOTICE:**

We will reject and return to sender returns that are not accompanied by an AMAX issued RMA form and RMA number so make sure to contact our warranty center before attempting to return your product!

### **PREPARATION FOR SHIPPING YOUR PRODUCT:**

Please repack your product in a durable box, preferably in the original carton, and send it prepaid, and adequately insured. Include the RMA form that was issued by our warranty department along with your daytime telephone number and email address inside the shipping carton. If your warranty has expired and you still require service please contact our customer care team For further information please send all inquiries to:

[customercare@amaxbrands.com](mailto:customercare@amaxbrands.com)

### **IMPORTANT NOTICE!**

DO NOT ATTEMPT TO SHIP YOUR PRODUCT BACK WITHOUT FIRST CONTACTING OUR WARRANTY DEPARTMENT AT:

[www.amaxbrands.com](http://www.amaxbrands.com)

Email: [care@amaxglobal.com](mailto:care@amaxglobal.com)

Phone 1-866-360-1510

## **FCC Part 15 C Notice**

**CAUTION:** Changes or modifications not expressly approved by the party responsible for compliance could void the user's authority to operate the equipment.

**NOTE:** This equipment has been tested and found to comply with the limits for a Class B digital device, pursuant to Part 15 of the FCC Rules. These limits are designed to provide reasonable protection against harmful interference in a residential installation. This equipment generates, uses and can radiate radio frequency energy and, if not installed and used in accordance with the instructions, may cause harmful interference to radio communications. However, there is no guarantee that interference will not occur in a particular installation. If this equipment does cause harmful interference to radio or television reception, which can be determined by turning the equipment off and on, the user is encouraged to try to correct the interference by one or more of the following measures:

- Reorient or relocate the receiving antenna.
- Increase the separation between the equipment and receiver.
- Connect the equipment into an outlet on a circuit different from that to which the receiver is connected.
- Consult the dealer or experienced radio/TV technician for help.

This device complies with Part 15 of the FCC Rules. Operation is subject to the following two conditions :

1. This device may not cause harmful interference, and

2. this device must accept any interference received, including interference that may cause undesired operation.

This equipment complies with FCC/ IC radiation exposure limits set forth for an uncontrolled environment. This equipment should be installed and operated with minimum distance 20cm between the radiator and your body.

**INDUSTRY CANADA NOTICE: CANADA ONLY.**

This device contains license-exempt transmitter(s)/receiver(s) that comply with Innovation, Science and Economic Development

Canada's license-exempt RSS(s). Operation is subject to the following two conditions:

1. This device may not cause interference.
2. This device must accept any interference, including interference that may cause undesired operation of the device.

This product is manufactured by Amax Group  
12645 Memorial Drive Suite F1 #388 Houston, TX 77024  
Propel™ and Propel RC™ are the licensed trademarks of Rooftop Group LTD Singapore.  
©2020 All rights reserved. Visit us at [www.propelrc.com](http://www.propelrc.com)

**CAN ICES-3(B)/NMB-3(B)**

This product meets the applicable Innovation, Science and Economic Development Canada technical specifications.

Conforms to safety requirements of FCC, RSS247, RSS210.

Costco Wholesale Canada Ltd.\*415 W. Hunt Club Road  
Ottawa, Ontario  
K2E 1C5, Canada  
1-800-463-3783  
[www.costco.ca](http://www.costco.ca)



Made in China  
CT-6168  
C004-CA-V1.0

---

Propel Flex 2.0 Drone Manual – [Optimized PDF](#)  
Propel Flex 2.0 Drone Manual – [Original PDF](#)