



**DEERC**

**14+**  
age

# Instructions For Use

日本語マニュアル

# Gebrauchsanweisungen

V1.0

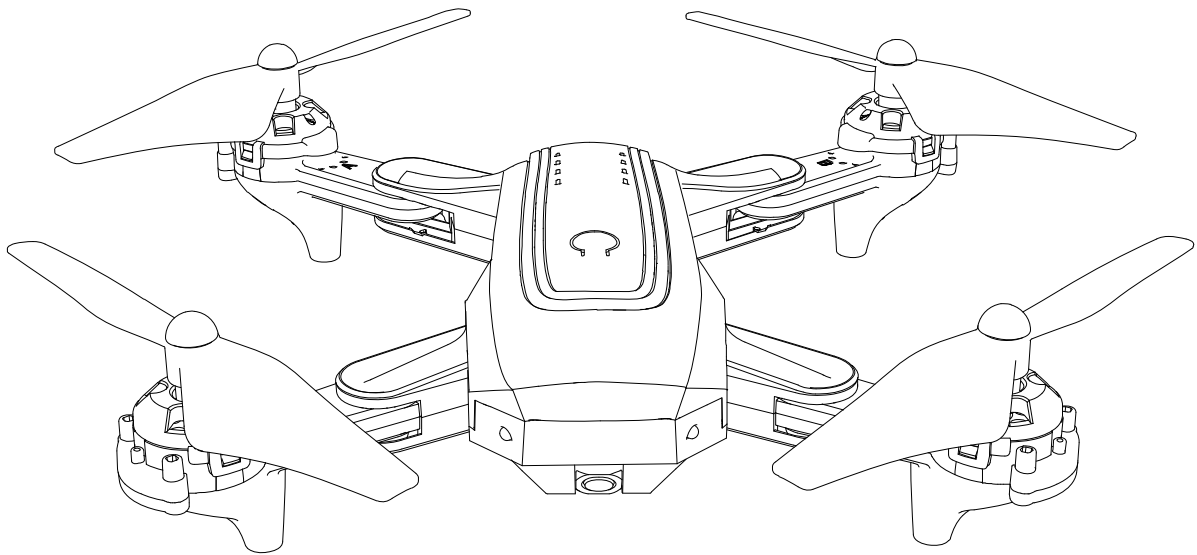

D10

✉ [usa@deerc.com](mailto:usa@deerc.com) (USA)

[jp@deerc.com](mailto:jp@deerc.com) (JP)

[eu@deerc.com](mailto:eu@deerc.com) (EU)

English 01-20

日本語 21-39

Deutsch 40-56

# Contents

1.0 Disclaimer&Warning .....	01
2.0 Safety Guidelines .....	01
3.0 Maintenance .....	04
4.0 Package Contents .....	05
5.0 Transmitter Functions .....	06
6.0 Installation	
Transmitter Battery .....	06
Protection Guards .....	07
Propellers .....	07
7.0 Take Photo / Video .....	07
8.0 Using the Application .....	08
9.0 Operation Guide	
Direction Control .....	09
Trimming Operation .....	10
Pairing .....	10
10.0 Battery Installation and Charging .....	11
11.0 Functions Details	
Low-voltage Protection .....	11
Over-current Protection .....	11
Calibrate the Gyro .....	12
360° Flip .....	12
Altitude-hold .....	12
Headless Mode .....	12
12.0 Specifications .....	13
13.0 Trouble Shooting .....	15
14.0 Contact Us .....	15
15.0 General Information .....	16

## DISCLAIMER & WARNING

1. Please read this Disclaimer & Warning and Safety Guidelines carefully before using our product. This product is not recommended for people under the age of 14. By using this product, you hereby agree to this disclaimer and signify that you have read it fully. You agree that you are responsible for your own conduct and any damaged caused while using this product, and its consequences . You agree to use this product only for purposes that are proper and in accordance with local regulations, terms and all applicable polices and guidelines Deerc may make available.

2. When using this product, please be sure to strictly abide by the specification requirements and safety guidelines stated in this document. Any personal injury property damage, legal disputes and all other adverse events caused by the violation of the safety instructions or due to any other factor, WILL NOT be Deerc's responsibility.

## SAFETY GUIDELINES

### 1. Check Before Use

① This product is a high precision drone that integrates various electronic stability and control mechanisms. Please be sure to setup this drone carefully and correctly to ensure safe, accident-free operation.

② Please be sure that the batteries of the drone and transmitter are clean, undamaged and, fully charged.

③ Please be sure that all the propellers are undamaged and are installed in the correct orientation.

④ Please do a thorough check of the product before each use. Inspect the integrity of the parts, any signs of cracks and wear of the propeller, battery power and effectiveness of the indicator, etc. If after doing a complete check any issues are found, please refrain from using the product until the issue has been resolved.

# SAFETY GUIDELINES

## 2.2 Flight Environment



+



+



Fly in Open Areas

Maintain Line  
of Sight

Fly Below  
328 feet (100 m)



Avoid flying over or near obstacles, crowds, high voltage power lines, trees, airport or bodies of water.

DO NOT fly near strong electromagnetic sources such as power lines and base stations as it may affect the onboard compass.



DO NOT use the drone in adverse weather conditions such as rain, snow, fog and strong wind.

## 2.3 Operations Requirements

- ① Do not follow moving vehicles.
- ② During the flight, only turn off the motor in case of an emergency.
- ③ Please flight the drone back to you as soon as possible when the battery is running low.
- ④ This product should not be used while drinking alcohol, if you are feeling fatigued, taking medicine, or feeling any physical discomfort.
- ⑤ Beware of the noise volume the drone produces. Keep your distance to avoid ear damage.

## SAFETY GUIDELINES



**Stay away from the rotating propellers and motors.**



**No Fly Zone**

### 2.4 Use of Battery

- ① Please ensure batteries are fitted in the correct orientation as shown in the instruction manual.
- ② Avoid short circuits by fitting the batteries correctly, and do not crush or squeeze the batteries as this could carry the risk of an explosion.
- ③ Do not mix new and old batteries as this can lead to a poor performance of the product.
- ④ Dispose used batteries carefully, do not litter.
- ⑤ Please keep dead batteries away from heat and fire.
- ⑥ If the device is not going to be used for an extended period of time, remove batteries to prevent potential damage from battery leakage.
- ⑦ If the device is not going to be used for an extended period of time, remove batteries to prevent potential damage from battery leakage.
- ⑧ It is recommended to only use the USB charging cable that comes with the drone to charge the battery.
- ⑨ Don't connect the battery directly to wall outlets or car cigarette-lighter sockets.
- ⑩ Don't attempt to disassemble or modify the battery in any way.
- ⑪ Don't use the battery if it gives off an odor, generates heat, becomes discolored or deformed, or appears abnormal in any way. If the battery is in use or being charged, remove it from the device or charger immediately and discontinue use.

## SAFETY GUIDELINES

- ⑫ Don't pierce the battery casing with a nail or other sharp object, break it open with a hammer, or step on it!
- ⑬ Always charge the batteries in a fireproof container and away from combustible materials. Don't charge on surfaces that can catch fire. This includes: wood, cloth, carpet, or in the application's device.
- ⑭ Don't immerse the battery in water or allow it to get wet.
- ⑮ Don't solder battery terminal directly.
- ⑯ Keep battery out of reach of children or pets.
- ⑰ Don't short-circuit the battery by connecting wires or other metal object to the positive(+) and negative(-) terminals.



**Li-Po Battery Disposal & Recycling**

Waste Lithium-polymer batteries must not be placed with household trash.  
Please contact local environmental or waste agency or the waste agency  
or the supplier of your model or your nearest Li-Po battery recycling center.



## MAINTENANCE

1. Clean the product after each use with a clean, soft cloth.
2. Avoid prolonged exposure to direct sunlight and avoid buildup of heat on the drone.
3. This device is not waterproof and must not be submerged in water under any circumstance. Failure to maintain the device completely dry will result in the failure of the unit.
4. Check the charging plug and other accessories for signs of damage frequently. If any part of the device is damaged, refrain from flying until maintenance can be carried out.

# PACKAGE CONTENTS

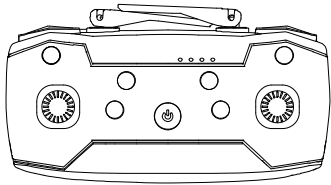

Transmitter × 1

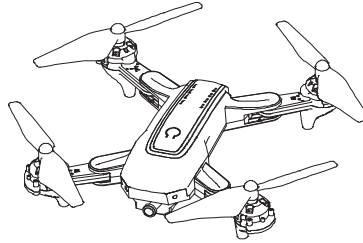

Drone × 1

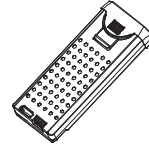

Battery × 2



Spare Propellers × 4

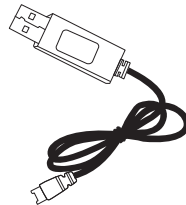

USB Charging Cable × 1

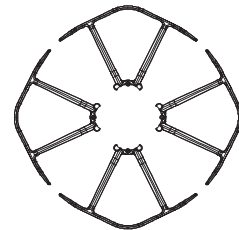

Propeller Guard × 4



Screwdriver × 1

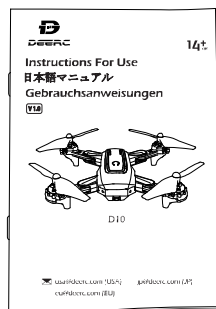

Instructions For Use × 1



## TRANSMITTER DETAILS

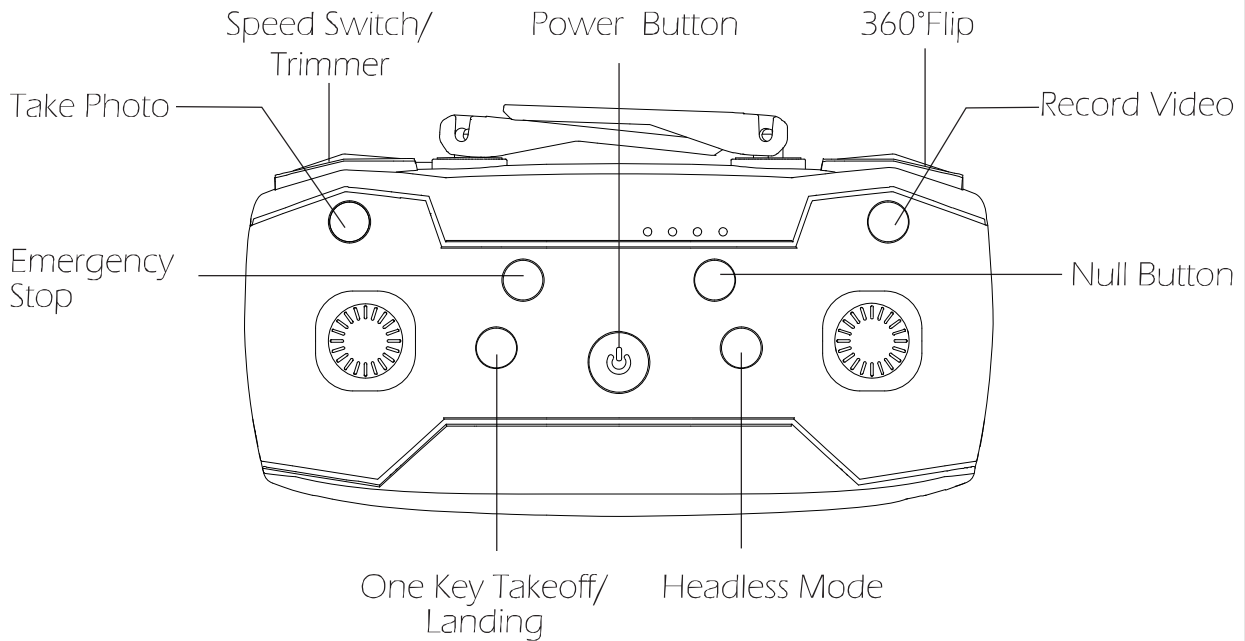

To enter MODE 1, turn on the transmitter while holding the “Null Button” button. (Please do not release the “Null Button” button until the transmitter is powered on.)

## INSTALLATION

### Transmitter Battery:

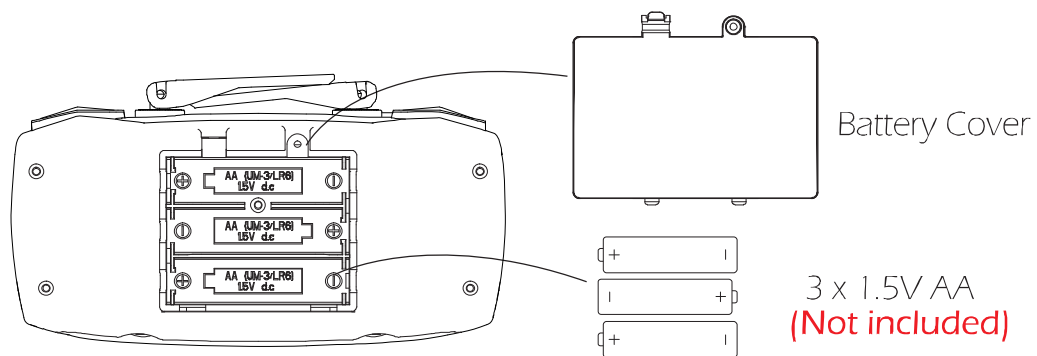

Open the battery cover and install 3\*AA batteries into the battery compartment according to the given polarity.



- Insert batteries with correct polarity.
- Do not mix old and new batteries.
- Exhausted batteries are to be removed from the transmitter.

## INSTALLATION

### Protection Guards:

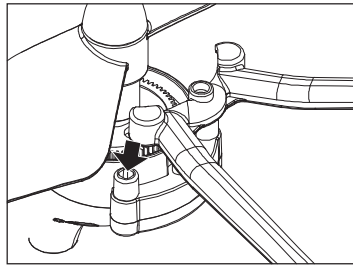

Insert the protection guard into the motor base as shown.

Tips: This 360° flip function will perform better without protection guards.

## INSTALLATION

### Propellers:

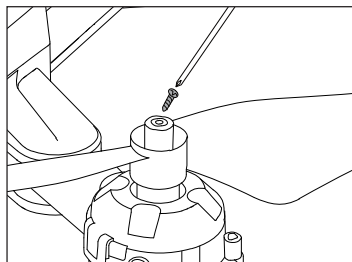

Pic 1

1. Install the propeller in the corresponding position and tighten the screws.(Pic 1)

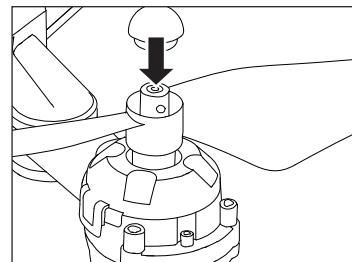

Pic 2

2. Finally, install the leaf cap to complete the installation.(Pic 2)

## TAKE PHOTO / VIDEO

**1. Take Photo:** Press the “Take Photo” button on the transmitter. When one beep is heard from the transmitter and the indicator light on the drone flashes once, this indicates the camera has successfully taken a picture.

**2. Record Video:** Short press the “Record Video” button on the transmitter. Two beeps from the transmitter will be heard and the indicator light on the drone will flash twice. This tells you that the camera has started recording video. By pressing the video button again, when the indicator light flashes two times to exit the recording.

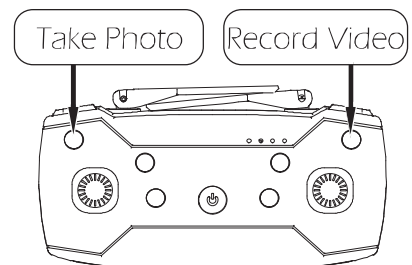

## USING THE APPLICATION

### 1. Download APP



iOS



Android APP on Google play

Scan the QR code, connect to the App Store™ or Google Play™ and download the “ **WIFI Drone** ” application for free.

Required Operating Systems: iOS 9.0 or later / Android 4.3 or later

### 2. Connect Wi-Fi Networks

Connect your smart phone to the Wi-Fi of the Drone and check the drone’s status on the “ **WIFI Drone** ” App.

- ① Your smart phone will launch a search of the available Wi-Fi networks.
- ② Select the Wi-Fi network: **Wifi\_Drone\_\*\*\*\*\***.
- ③ Wait your smart phone for several seconds to connect the Wi-Fi network of the drone.

*This connection is generally represented by the Wi-Fi logo appearing on your smart phone’s screen.*

- ④ Enter the “**WIFI Drone**” application.

> The connection between your smart phone and the Drone is established automatically.

## OPERATION GUIDE

All of the following operations on this manual takes MODE 2 for example.

### Direction control

#### Ascend and descend

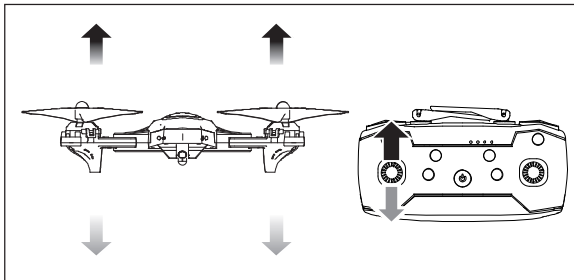

When the left joystick (throttle) is pushed upwards or downwards, the drone will ascend or descend correspondingly.

#### Forward and backward

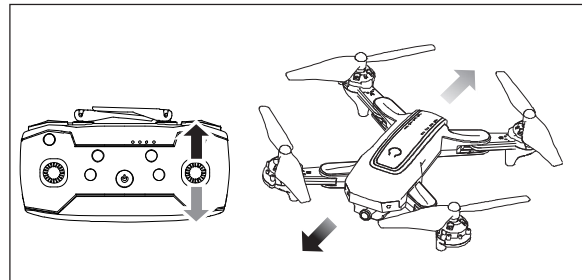

When the right joystick (direction) is pushed upwards or downwards, the drone will fly forward or backward correspondingly.

#### Rotate left and rotate right

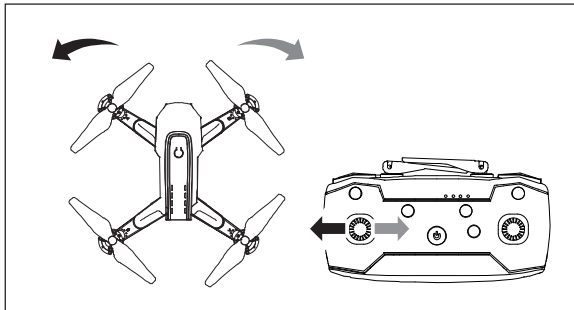

When the left joystick (throttle) is pushed towards the left or right, the drone will turn left or right correspondingly.

#### Fly to left and fly to right

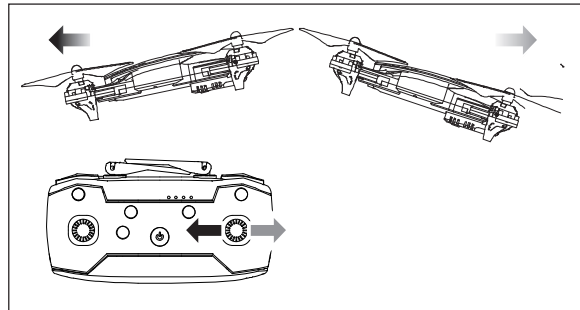

When the right joystick (direction) is pushed towards the left or right, the drone will fly sideways on the left or right correspondingly.

## OPERATION GUIDE

### Trimming Operation

#### Forward and backward trim

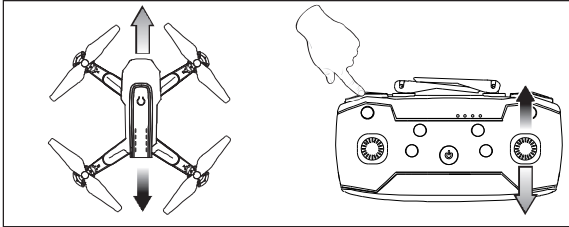

**F/B Sideward Fly Trim:** If the drone drifts forward, press the “Speed Switch” button and push the right joystick down at the same time to re-balance the drone. If the drone drifts backward, press the “Speed Switch” button and push the right joystick up at the same time to re-balance the drone.

#### Left/right side flight trim

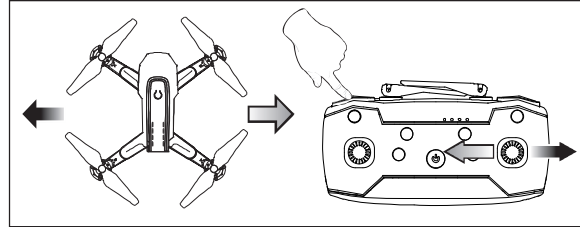

**L/R Sideward Fly Trim:** If the drone drifts left, press the “Speed Switch” button and push the right joystick right at the same time to re-balance the drone. If the drone drifts to right, press the “Speed Switch” button and push the right joystick left at the same time to re-balance the drone.

## PAIRING

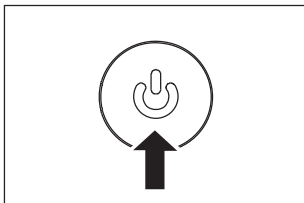

Pic 1

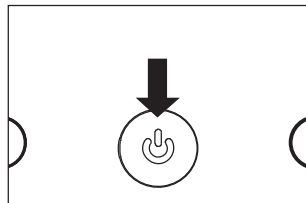

Pic 2

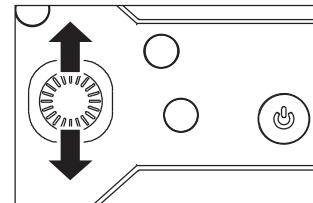

Pic 3

1. Push the battery into the battery compartment and press the power button of the drone to power on the drone.(Pic 1)
2. Press the power button of the transmitter.(Pic 2)
3. Push the left (throttle) joystick up then down to pair the drone with the transmitter. When the transmitter beep two times and the power indicator light turn solid, indicating that the drone and the transmitter are paired successfully.(Pic 3)

## BATTERY INSTALLATION AND CHARGING

### Installation:

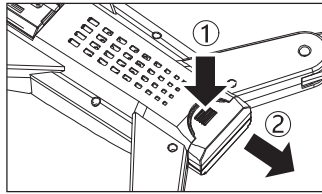

1. Press and hold the position shown and pull out the battery to remove the battery.

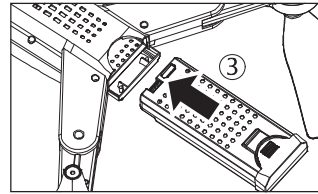

2. After charging completed, replace the battery into the drone.

### Charging:

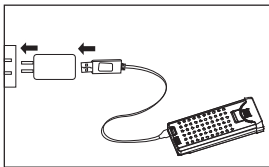

Connect the USB charging cable to the battery charging interface and plug the USB charging cable into a USB charging port on the compute or USB adapter. The red indicator light on the USB charging cable will turn off when the battery is charging, and will turn on when the battery is fully charged.

*(Tips: If the battery is plugged into the charger and there is no change in the light indicator, this indicates that the battery is fully charged.)*

The charging time is about 90 minutes and flight time is approximately 12 minutes.

## FUNCTIONS DETAILS

### 1. Low-Voltage Protection:

When the four indicator lights at the bottom of drone start flashing, it means that the drone's battery power is low. At this time, please control the drone return.

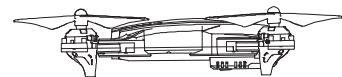

### 2. Over-Current Protection:

When the drone encounters direct impact from a foreign object, or is obstructed, or the blades are not rotating, the drone will go into the over-current protection mode.

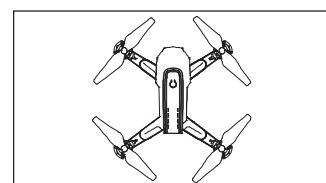

## FUNCTIONS DETAILS

### 3. Calibrate the Gyro:

Push the left and right joystick simultaneously to the lower left corner to calibrate the gyro. The LED lights on the drone will blink quickly and turn solid. When you hear one beep from the transmitter that indicates the calibration is completed.

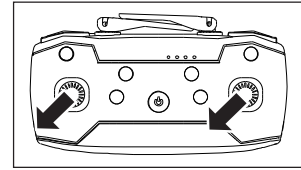

### 4. 360° Flip:

When you get familiar with all the functions of the drone, you can try this amazing flip mode. When you fly the drone at least 10 feet, press the 360° Flip button on the upper right of the transmitter, then push the right joystick Forward/ Backward or Left/ Right, and the drone will do a flip towards the corresponding direction. (This function will perform better when the battery is fully charged.)

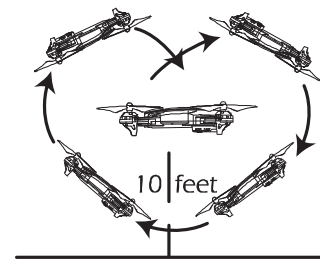

### 5. Altitude-Hold:

After using the left joystick to control the ascending/ descending flight of the drone, release the left joystick and the drone will hover at that height when the joystick is released.

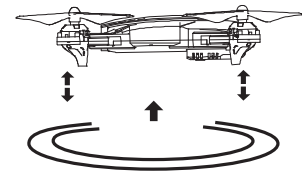

### 6. Headless Mode:

Under Headless Mode, the forward direction is the direction that the head of drone faces when the drone is pairing.

1. After pairing, or during the flight of the drone, press the Headless Mode button on the transmitter. A beep will be heard from the transmitter, and the lights on the drone will keep blinking. The transmitter will beep slowly to indicate that drone is in Headless Mode. Press the Headless Mode button again, and you will hear "Di" and the LED indicator lights on the drone will be solid, which indicates the drone exits the Headless Mode.
2. Under the headless mode, the operator does not need to differentiate the head position of the drone, and only needs to control the drone's direction front/ back/ left/ right by using the right joystick direction on the transmitter.

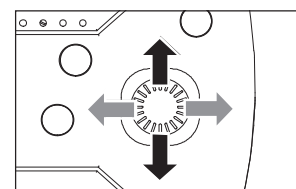
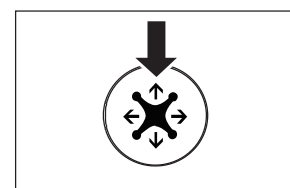

## SPECIFICATIONS

DRONE	
Model	D10
Weight	158g/ 5.57oz
Flight Time	12 minutes
Motor Model	8620
Operating Temperature Range	32° to 104°F (0° to 40°C)
Dimensions	340 x 340 x 65mm
FLIGHT BATTERY	
Capacity	1300mAh
Voltage	3.7 V
Battery Type	Li-Po Battery
Energy	4.81Wh
Charging Temperature Range	41° to 104°F (5° to 40°C)
Charging Time	90 minutes <i>(depends on charging power and remaining battery power)</i>
CAMERA	
Lens Angle	55°
Video/Photo Resolution	1280 x 720P
Image Return Distance	197feet / 60m <i>(outdoors and unobstructed)</i>
Transmission frame rate	25 fps
Photo	JPEG
Video	AVI / MP4
Operating Temperature Range	32° to 104°F (0° to 40°C)



## SPECIFICATIONS

TRANSMITTER	
Operating Frequency	2.4 GHz
Transmission Distance	328feet / 100 m (outdoors and unobstructed)
Operating Temperature Range	32° to 104°F (0° to 40°C)
Battery Type	3 x 1.5V AA Battery (not included)
USB CHARGING CABLE	
Voltage	5 V
Rated Power	≤10 W

## TROUBLE SHOOTING

Problems	Reasons	Solutions
The drone has no response.	<ol style="list-style-type: none"> <li>1. The drone has entered into low-voltage protection.</li> <li>2. When the power of the transmitter is weak, the power light indicator will blink.</li> </ol>	<ol style="list-style-type: none"> <li>1. Charge up the drone.</li> <li>2. Change the batteries of the transmitter.</li> </ol>
The drone is flying towards its side in one direction during hovering.	<ol style="list-style-type: none"> <li>1. No calibration or trimming.</li> </ol>	<ol style="list-style-type: none"> <li>1. Re-adjust the calibration.</li> </ol>
One or two motors do not work.	<ol style="list-style-type: none"> <li>1. Check if the propellers are installed incorrectly.</li> <li>2. Motor loss or motor line disconnection on the motherboard.</li> </ol>	<ol style="list-style-type: none"> <li>1. Replace the propellers.</li> <li>2. Open the drone and check the line on the motherboard.</li> </ol>

## CONTACT US

Please do not hesitate to contact us if you need further support.

✉ [usa@deerc.com](mailto:usa@deerc.com) (USA)  
[jp@deerc.com](mailto:jp@deerc.com) (JP)  
[eu@deerc.com](mailto:eu@deerc.com) (EU)

## GENERAL INFORMATION

FCC Notice:

This device complies with Part 15 of the FCC Rules.

Operation is subject to the following two conditions:

- (1) This device may not cause harmful interference.
- (2) This device must accept any interference received, including interference that may cause undesired operation.

NOTE: This equipment has been tested and found to comply with the limits for a Class B digital device, pursuant to Part 15 of the FCC Rules. These limits are designed to provide reasonable protection against harmful interference in a residential installation. This equipment generates uses and can radiate radio frequency energy and, if not installed and used in accordance with the instructions, may cause harmful interference to radio communications. However, there is no guarantee that interference will not occur in a particular installation. If this equipment does cause harmful interference to radio or television reception, which can be determined by turning the equipment off and on, the user is encouraged to try to correct the interference by one or more of the following measures:

- Reorient or relocate the receiving antenna.
- Increase the separation between the equipment and receiver.
- Connect the equipment into an outlet on a circuit different from that to which the receiver is connected.
- Consult the dealer or an experienced radio/TV technician for help.

WARNING: Changes or modifications not expressly approved by the party responsible for compliance could void the user's authority to operate the equipment.

### RF Exposure

This equipment complies with FCC radiation exposure limits set forth for an uncontrolled environment. This equipment should be installed and operated with minimum distance 20cm between the radiator & your body.

## GENERAL INFORMATION

### HOW TO RECYCLE THIS PRODUCT

This symbol on the product or its documentation indicates that it must not be disposed of with household waste.

Uncontrolled waste disposal may harm the environment or human health.

Please separate your device from other types of waste to recycle it responsibly.

This will help to foster the sustainable re-use of material resources.

We invite you to contact your retailer or inquire at your local town hall to find out where and how the drone can be recycled.

### BATTERY WARNING:

1. Failure to follow all the instructions may result in serious injury, irreparable damage to the battery and may cause a fire, smoke or explosion.
2. Always check the battery's condition before charging or using it.
3. Replace the battery if it has been dropped, or in case of odour, overheating, discolouration, deformation or leakage.
4. Never use anything other than the approval LiPo charger the battery. Always use a balancing charger for LiPo cells or a LiPo cell balancer. It is recommended that you do not to use any other charger than the one provided with the product.
5. The battery temperature must never exceed 60°C(140°F) otherwise the battery could be damaged or ignite.



## GENERAL INFORMATION

6. Never charge on a flammable surface, near flammable products or inside a vehicle(perferably place the battery in a non-flammable and nonconductive container).
7. Never leave the battery unattended during the charging process. Never disassemble or modify the housing's wiring, or puncture the cells. Always ensure that the charger output voltage corresponds to the voltage of the battery. Do not short circuit the batteries.
8. Never expose the LiPo battery to moisture or direct sunlight, or store it in a place where temperatures could exceed 60°C(car in the sun, for example).
9. Always keep it out of reach of children.
10. Improper battery use may result in a fire, explosion or other hazard.
11. Non-rechargeable batteries are not to be recharged. Rechargeable batteries are only to be charged under adult supervision.
12. Different types of batteries or new and used batteries are not to be mixed.
13. Batteries are to be inserted with the correct polarity.
14. The supply terminals are not to be short-circuited. Regular examination of transformer or battery charger for any damage to their cord, plug, enclosure and other parts and they must not be used until the damage has been repaired.
15. The packaging has to be kept since it contains important information.
16. The toy is only to be connected to Class II equipment bearing the symbol.



## GENERAL INFORMATION

### Caution

- 1.The max operating of the EUT is 45°C. and shouldn't be lower than -10°C.
- 2.Declaration of Conformity.

We, Xiamen Huoshiquan Import & Export CO., LTD  
hereby, declare that the essential requirements compliance with the  
Directive 2014/53/EU, the RoHS Directive 2011/65/EU and Safety  
Directive 2009/48/EC have been fully fulfilled on our product with  
indication below:

The Statement of compliance is available at the following address:  
[http://www.holystone.com/docs/D10\\_EU\\_DOC.pdf](http://www.holystone.com/docs/D10_EU_DOC.pdf)

This product can be used across EU member states.

### MANUFACTURER INFORMATION

Manufactured by  
Xiamen Huoshiquan Import & Export Co.,Ltd.  
Room 703,No. 813-2 Xiahe Road, Siming District, XIAMEN, China  
+1(855) 888-6699



**Made in China**