



PHANTOM PILOT TRAINING GUIDE

Earning Your Stripes V1.1



CAUTION

AGES

18+



WARNING!
Rotating parts may cause injury

This product is not suitable for people under the age of 18. Please carefully read the “Quick Start Guide”, “User Manual”, “Disclaimer”, and fully watch the tutorial videos before using the PHANTOM. Users should make every effort to fly regularly in order to improve their flight skills as an advanced level pilot (★★★). Please fly safely and responsibly.

Please follow these guidelines prior to flying your Phantom:

- 1 Always turn on the Remote Controller prior to turning on the Phantom.
- 2 Toggle S1, S2 to the top.
- 3 Be sure there are no distractions when you’re flying.
- 4 When starting your training, be sure you are in a very large open area. Be aware of your surroundings. Always fly in areas void of obstacles and away from traffic and people.
- 5 Before actually taking off, be sure you have calibrated the compass and you have full GPS satellite reception (Slow Continuous Green Flashing).
- 6 Never fly higher than 400 feet.
- 7 During training, stay behind your imaginary barrier and never fly behind yourself.
- 8 When in doubt, gently pull down on the throttle stick and land.
- 9 DO NOT PANIC.

The aircraft nose should face AWAY from the pilot before takeoff.



CAUTION

DO NOT fly the Phantom within a radius of 2 meters.



FORBIDDEN

DO NOT touch the propellers after the Phantom has been started.



NO TOUCH

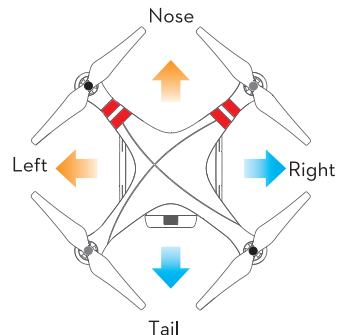

Basic Flight Maneuvers (★)

1 Take off and land with battery facing you.

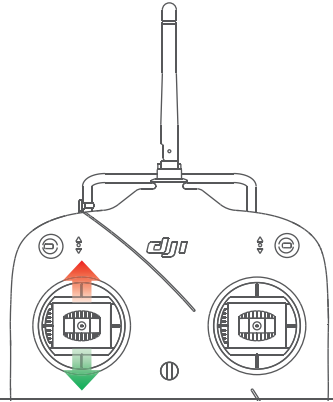
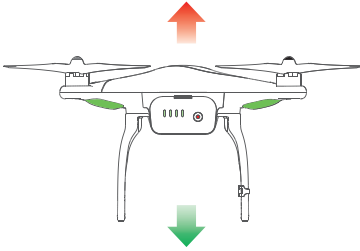

2 Hover in one spot keeping battery facing you, make sure to control Left/Right/Forward/Back movement.

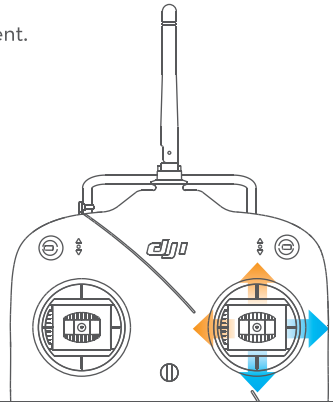
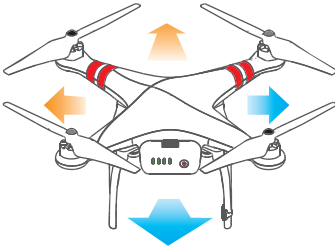

3 Rotate left, rotate right but try to keep the battery pointed at yourself.

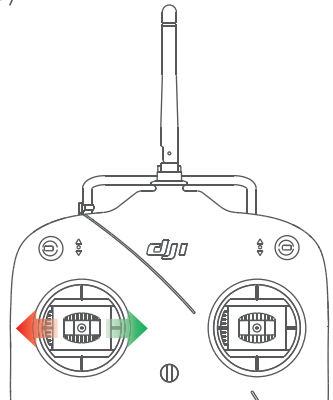
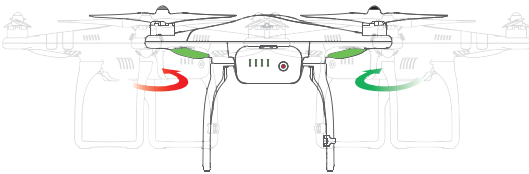

Basic Flight Maneuvers (★)

- 4** Slowly fly forward/back/left/right with back of Phantom pointed at yourself.

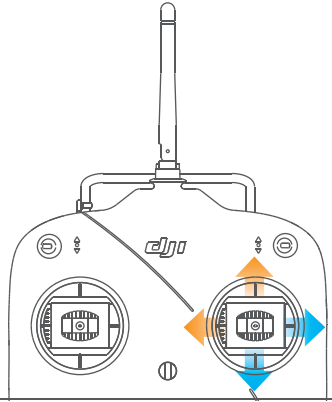
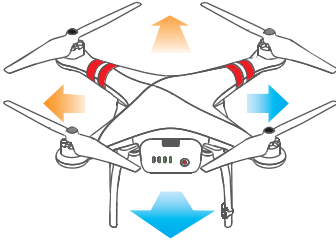

- 5** Fly forward to a spot 20-30 feet away. Then fly back keeping the battery pointed at yourself.

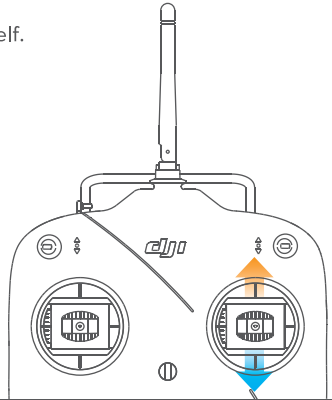
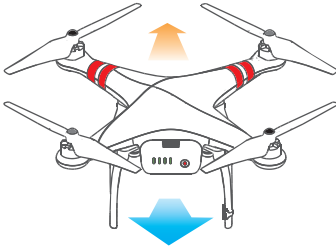

- 6** Mark a spot (B) on the ground 10ft away from the Phantom's take off point. Hover and fly towards that spot and land at the spot (B). Then go back into a hover and bring the Phantom back to its original position (A) and land again.

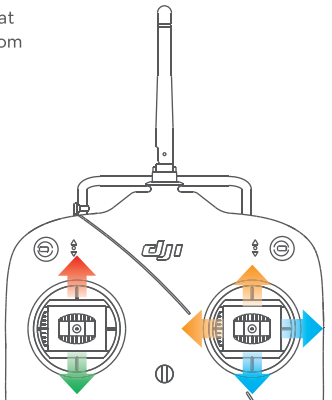
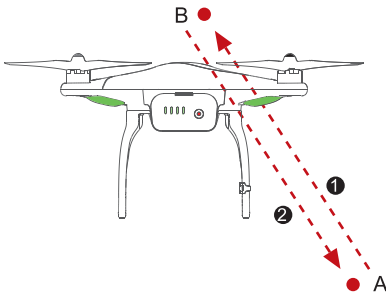

Basic Flight Maneuvers (★)

- 7** Fly left 3 meters away from your take-off point, then fly right 10ft from your take-off point all while keeping battery pointed at yourself.

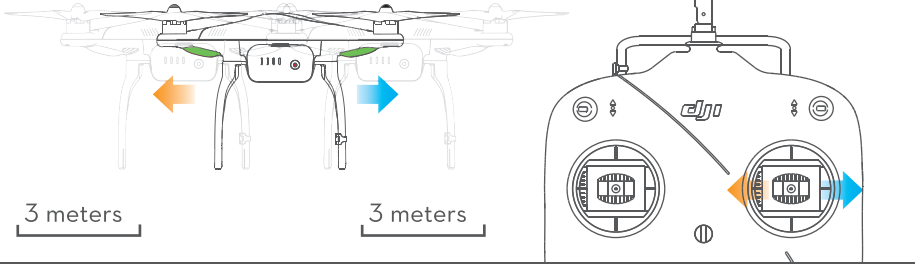

- 8** Then, while keeping the aircraft nose pointed forward, fly a 4 point square box formation going clockwise. Be sure to be in control and stop and hover in place at each point before proceeding to the next point.

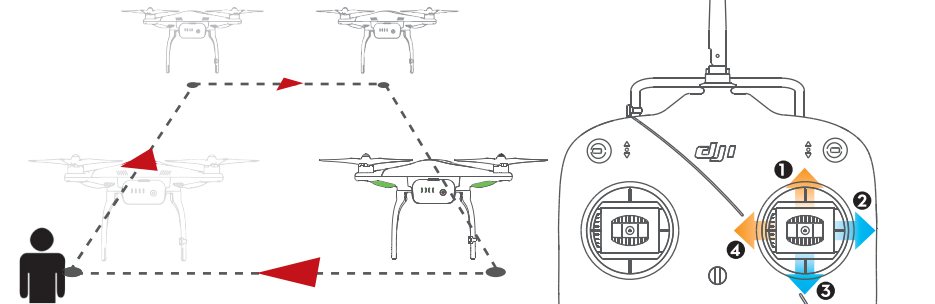

- 9** Do the same as above but fly the 4 point box formation counter-clockwise. Be sure to be in control and stop and hover in place at each point before proceeding to the next point.

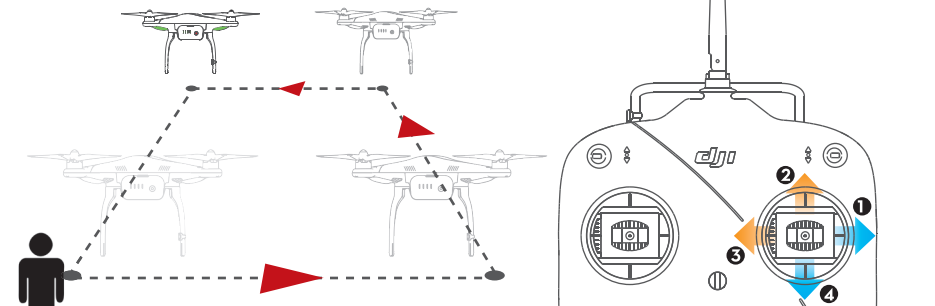

Skilled Flight Maneuvers (★★★)

- 1** In a hover, starting with the battery pointed at yourself, rotate 360 degrees clockwise.

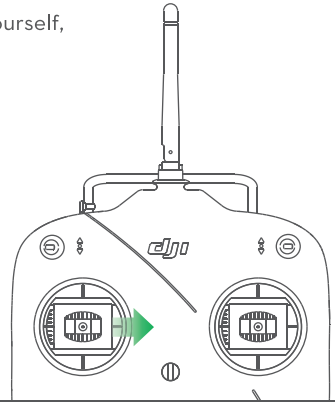
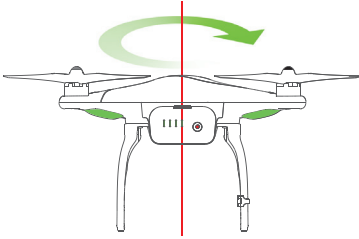

- 2** In a hover, starting with the battery pointed at yourself, rotate 360 degrees counter-clockwise.

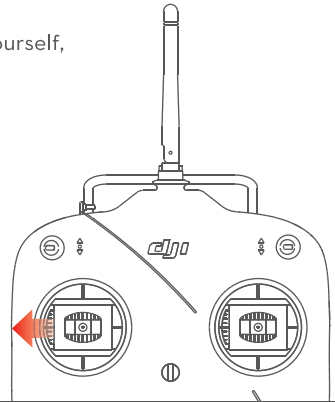
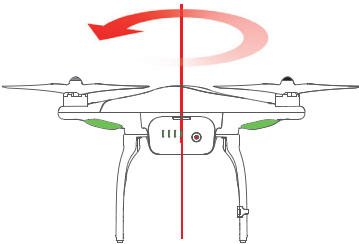

- 3** Starting with the battery pointed at yourself, go into a hover. Then rotate the Phantom 90 degrees facing left, and fly a 4 point square box formation going clockwise. Be sure to be in control and stop and hover in place at each point before proceeding to the next point.

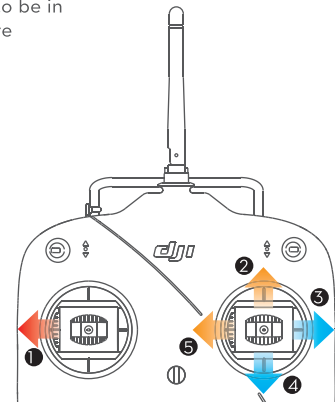
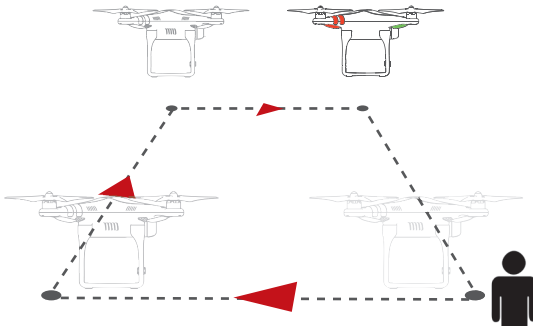

Skilled Flight Maneuvers (★ ★)

- 4** Starting with the battery pointed at yourself, go into a hover. Then rotate the Phantom 90 degrees facing right, and fly a 4 point square box formation going counter-clockwise. Be sure to be in control and stop and hover in place at each point before proceeding to the next point.

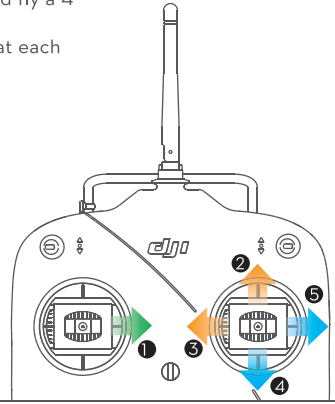
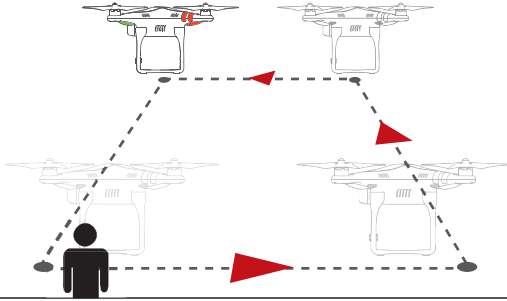

- 5** With the battery pointed at yourself, fly a circle. Try to keep the altitude and also the circle as uniform as possible.

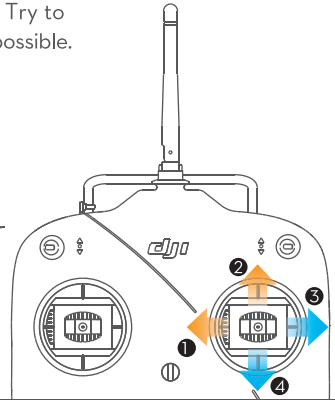
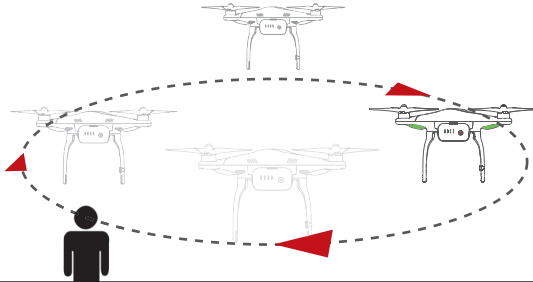

- 6** Hover with the aircraft nose pointed at yourself and try to keep the Phantom in one place.

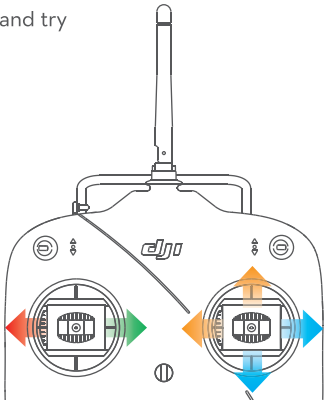
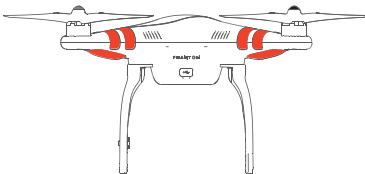

Advanced Flight Maneuvers (★ ★ ★)

- 1** Fly a circle and keep the aircraft nose pointed towards you. Be sure to keep the altitude the same and the circle as uniform as possible.

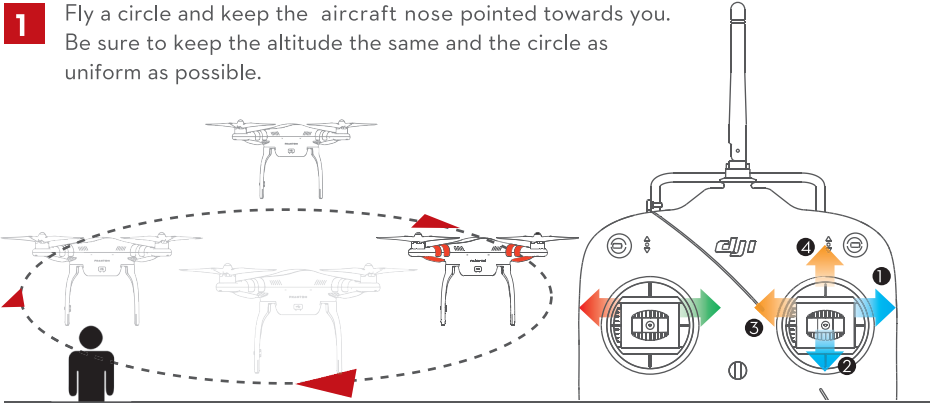

- 2** Fly a 4 point square box clockwise while keeping the aircraft nose facing in your direction.

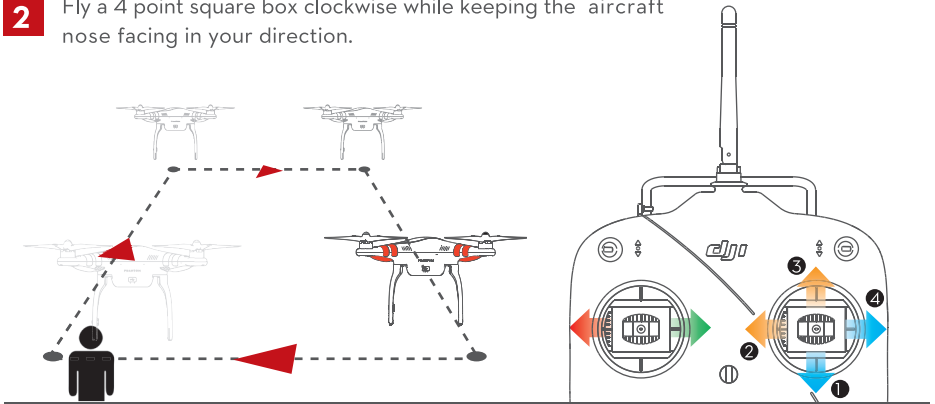

- 3** Fly a 4 point square box counter-clockwise while keeping the aircraft nose facing in your direction.

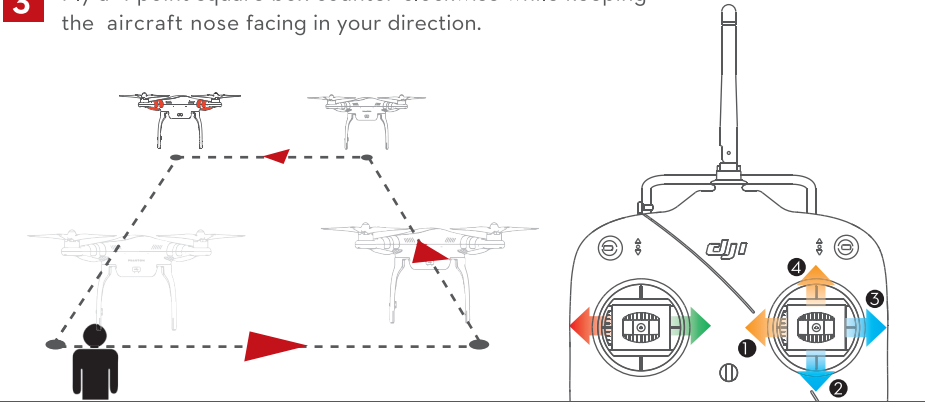

Advanced Flight Maneuvers (★ ★ ★)

- 4** Fly a 4 point square box clockwise and rotate the phantom in the direction of travel.

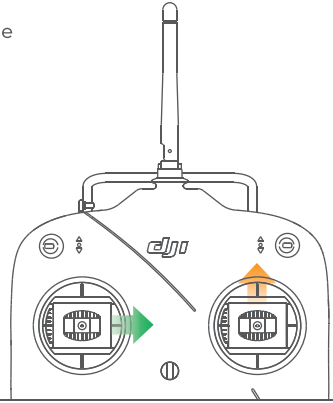
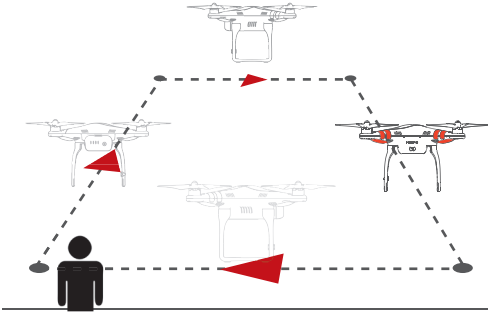

- 5** Fly a circle counter-clockwise and keep the aircraft nose pointed in the direction of travel. Be sure to keep the altitude the same and the circle as uniform as possible.

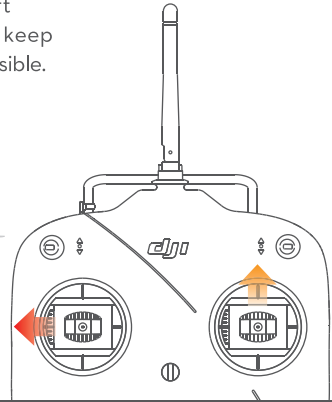
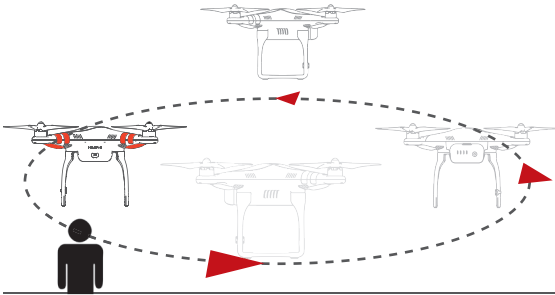

- 6** Fly a circle counter-clockwise with the aircraft nose pointed at the center of the circle. Be sure to keep the altitude the same and the circle as uniform as possible.

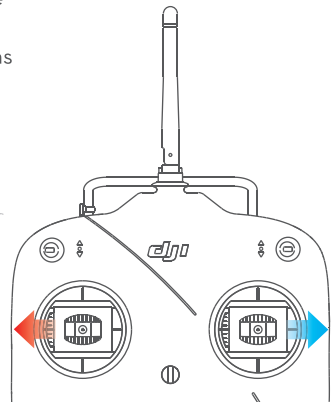
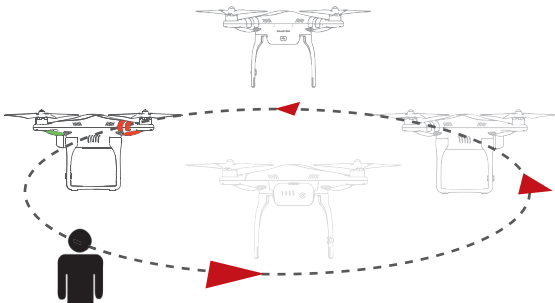

Advanced Flight Maneuvers (★ ★ ★)

- 7** Fly a figure 8 without rotating the Phantom. Be sure to keep the altitude the same and the circle as uniform as possible.

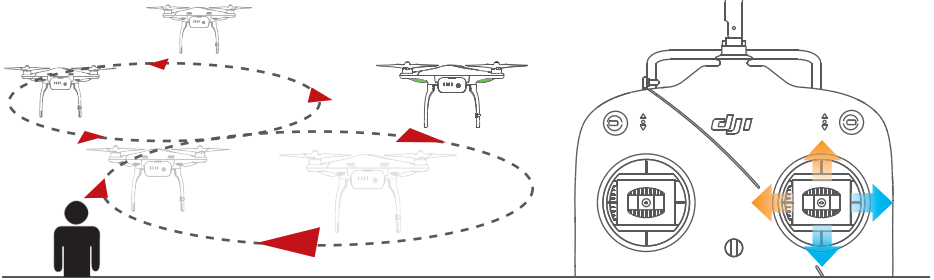

- 8** Fly a Figure 8 with the aircraft nose of the Phantom pointed in the direction of travel. Be sure to keep the altitude the same and the circle as uniform as possible.

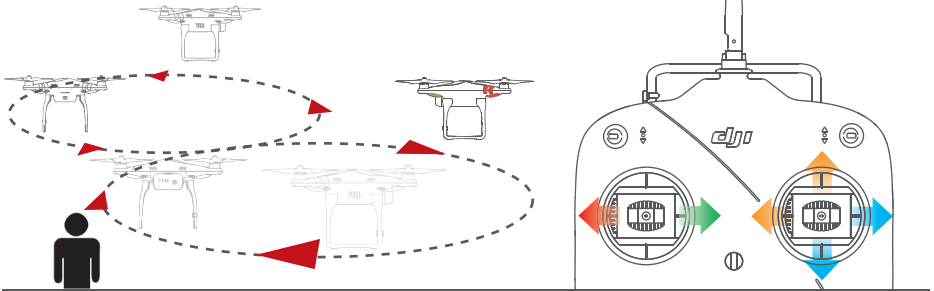

- 9** Fly Figure 8 patterns while experimenting with different orientations. For example, aircraft nose always pointed in a given direction or opposite/left/right the direction of travel, etc. Be sure to keep the altitude the same and the circle as uniform as possible.

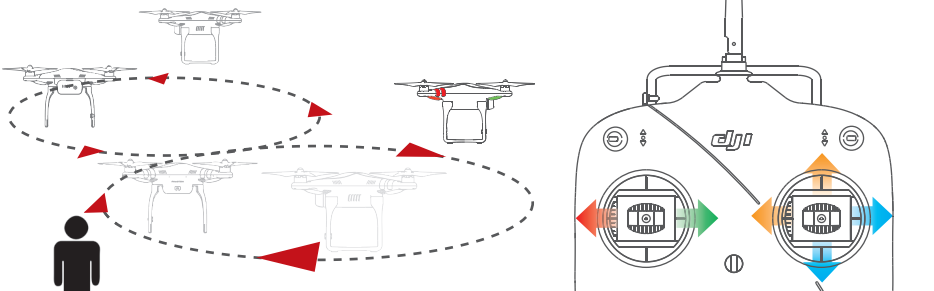

Emergency Situations

1 Return Home & Land Mode

Be sure you are in a large open area. Before you take off, make sure you have a good GPS lock by ensuring your LED indicators are flashing Green. Fly the Phantom at least 50ft away from your take off point. Turn off the Remote Controller. The Phantom will enter it's failsafe Return-To-Home Mode. Let the Phantom finish it's routine and land itself within 2 meters of the take off point.

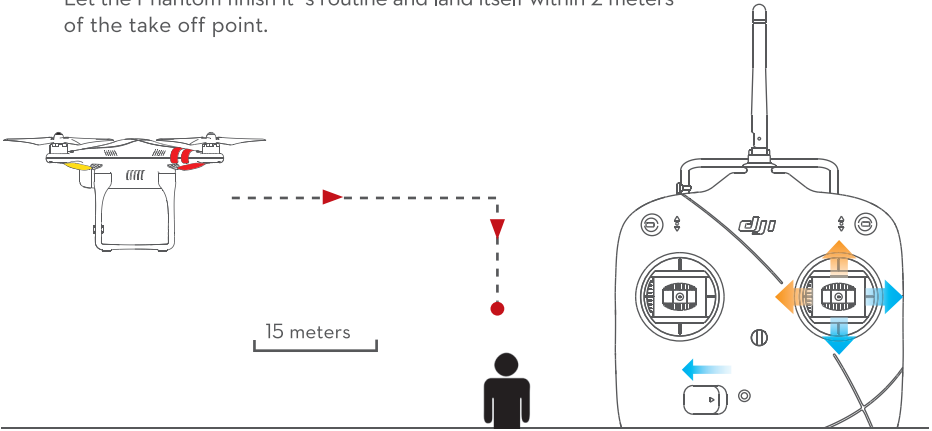

2 Intercepting Return Home & Land Mode

Be sure you are in a large open area. Before you take off, make sure you have a good GPS lock by ensuring your LED indicators are flashing Green. Fly the Phantom 50ft away from your take off point. Turn off the Remote Controller. The Phantom will enter it's failsafe Return-To-Home Mode. When the Phantom is returning home, you can intercept RTH Mode by switching the S1 Switch from the top position to the middle or lower position, then continue flying the Phantom.

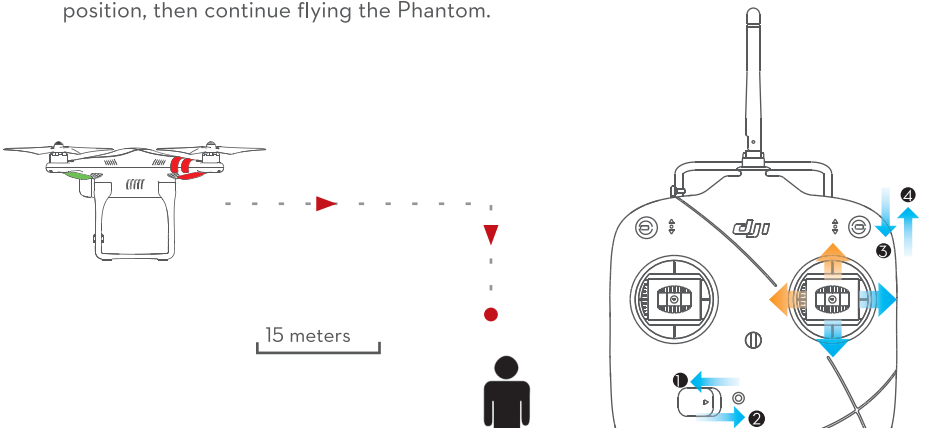

www.dji.com