

QX-20

Auto-Pathfinder 6 - Axis System

USER MANUAL



1 Installation instructions

1 The Propellers Installation

- (1) To prepare the quadcopter and propellers
- (2) The propeller with spin-mark should be installed upward, and to make sure the spin-mark of propellers and its equipped motor rotate in the same direction.
- (3) To use the hexagon wrench in the kits to tighten the ornament cap of the motor (Note:For the black ornament cap, to tighten the cap anticlockwise, for the silver cap, to tighten it clockwise).

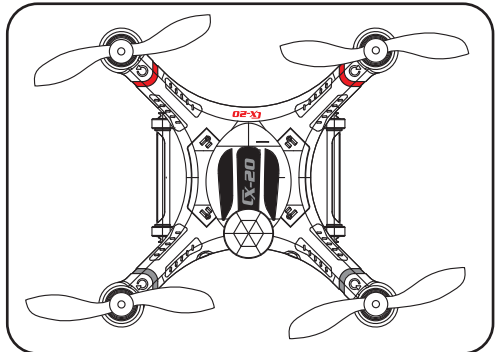
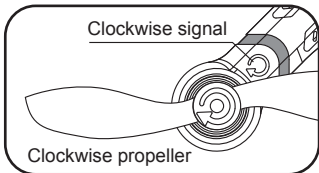
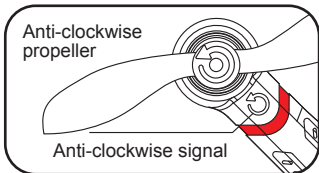

2 The Landing Gear & Antenna Installation

- (1) To prepare the quadcopter and landing gears.
- (2) To install the landing gear with the antenna hole on the body with antenna, and to fix the landing gear with the screws.
- (3) Install the other landing gear on other side, and to fix the landing gear with screws.
- (4) To place and fix the antenna in the groove of the landing gear with 3M scotch tape.

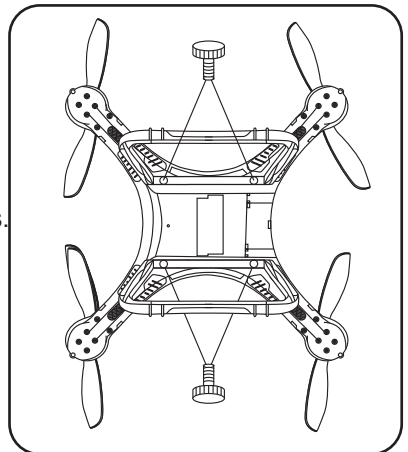

2 The instructions for the indicator lights and the status

1 LED instruction

The indicator light for the main control board calibration, motor unlock/lock instructional light (YELLOW light/RED light)

GPS signal instructional light (GREEN light)

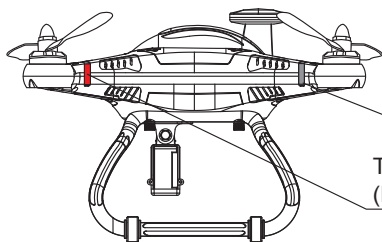
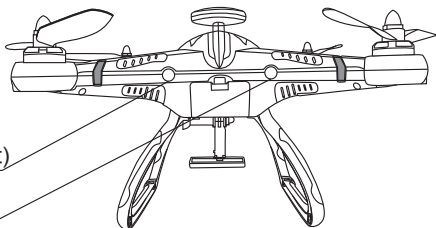

The rear downward LED (GREEN)

The front downward LED (RED)

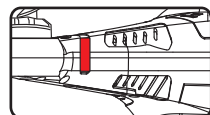

The front downward LED (RED)

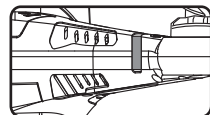

The rear downward LED (GREEN)

2 The descriptions of the LED indicator light status

- (1) The front indicator light: a. The red light keeps steady when the motor starts. b. The red light blinks in low voltage and there is a alarm sound if the frequency is below 1Hz.
- (2) The rear indicator light: a. the green light keeps steady when the motor starts. b. The green light blinks and there is a alarm sound if the frequency is below 1Hz.
- (3) The indicator light of the main control board calibration, motor lock/unlock indicator light. The yellow indicator light and red indicator light blink alternately when the main control board calibrates. The red light blinks slowly when the motor is locked, and the red indicator light keeps steady when motor is unlocked.
- (4) GPS signal indicator LED light: The green indicator light blinks when less than 6 satellites from the GPS system are received; the green indicator light keeps steady when more than 6 satellites from the GPS system are received. NOTE: The satellites received from the GPS system must be more than 6 satellites in Stable Mode and Return Home Modes. (The green indicator light keeps steady)

3 The transmitter functions and general settings (Mode 2)

1 The transmitter introduction

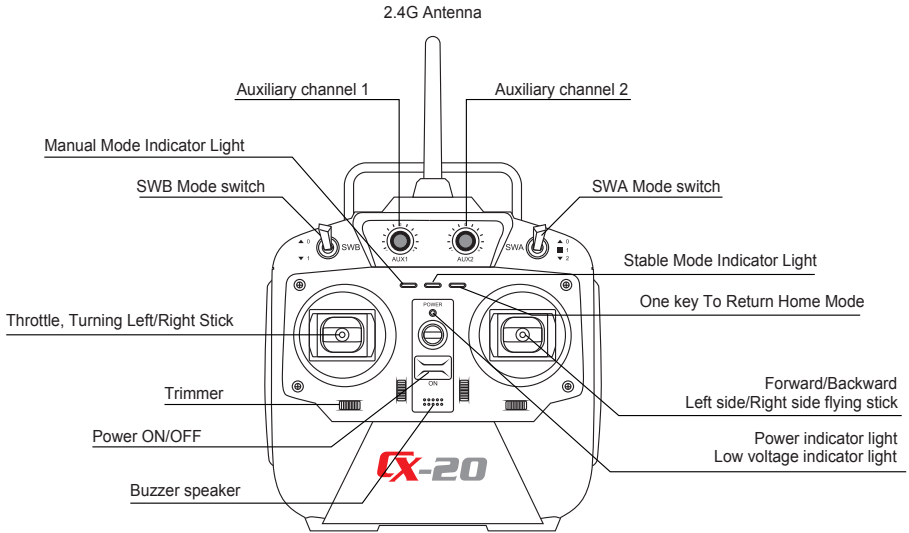

2 Transmitter Mode setting. (the CX-20 the example)

Mode type	SWA Setting	SWB Setting
Manual Mode	0	0
Stable Mode	1	0
Flight Direction Locked Mode	1	1
Altitude Sensor Mode	2	1
One Key To Return Home Mode	2	0

SWA Mode ON/OFF

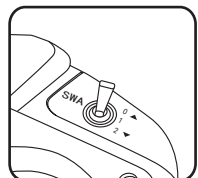

SWB Mode ON/OFF

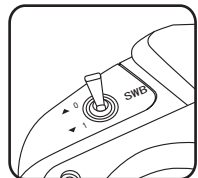

NOTE: No matter indoor or outdoor, to set the transmitter in Manual Mode before flying.

4 Basic operation

1. Binding

- (1) To insert the battery into the quadcopter battery container and connect them. The Red indicator light and the Green indicator light will blink rapidly alternately, please do not move and shake the quadcopter at this moment; to close the battery cover when the Red indicator light and the Green indicator light blink slowly alternately.
- (2) To turn on the transmitter, the binding with the quadcopter will succeed after the switching-on sound of the transmitter stops.
(NOTE: 1.To put the throttle stick to the lowest position before the binding.
2.SWA,SWB switches need to be in the "0" position.)

2. To receive the GPS signals

- (1) For the first time outdoor, it takes longer to get the GPS signals, please wait about 2 minutes until the LED light becomes steady.
- (2) Please do not use the GPS Modes (Stable Mode and Return Home Mode) indoor in order to avoid accidents.

3. Motor Unlock & Motor Lock

- (1) Motor Unlock: Once binding, to put down the throttle stick to the bottom right position. When the Red light become steady, the motors are unlocked.
- (2) Motor Lock: Once binding, to put down the throttle stick to the bottom left position. When the Red light blinks, the motors are locked.

4. Calibration:

If the quadcopter flies unsteadily, it needs to be recalibrated, the calibration methods are as follows:

- (1) To move the throttle stick to bottom left, the Red light and Green light blinks alternately, then it is locked.
- (2) To move the throttle stick to bottom right until the rear red and yellow lights blink alternately, then to take off the quadcopter and make it hover in the air for more than 20 seconds, and to land and lock it again. The quadcopter can fly steadily after it is re-unlocked.

Motor Unlock(left hand)

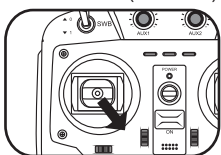

Motor Lock(left hand)

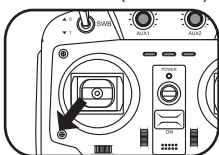

Motor Unlock(right hand)

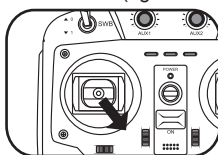

Motor Lock(right hand)

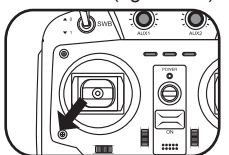

5 Mode Switched

- (1) Manual Mode: To set SWA on the "0" position, after the motors are unlocked, to push the throttle stick, then it can go forward/backward, go up/down, do left-side flying/right-side flying, turn left /right, etc.
- (2) Stable Mode: To take off the quadcopter and keep it in a certain height in Manual Mode, then to set SWA on the "1" position, SWB on the "0" position, the quadcopter will start to hover, then to push the throttle stick in the middle position, the quadcopter will keep in the current altitude and position.

NOTE:1.In stable Mode, the GPS signal indicator light should be steady, it means that the signal is good.

- 2.Stable is relative stable, it can move in a certain range depending on the speed of the wind and the weather, therefore you need enough safety space to fly it.
- 3.In Stable Mode, the throttle stick needs to be in the middle position, it gives out "beep, beep, beep..."sound when the throttle stick is in the middle position in order for you to better control it.
- (3) One Key to Return Home Mode: When you need the quadcopter to return back, to set the SWB on the "0" position, the SWA on "2" position. Then the quadcopter will return back from the returning point to the starting point straightly. If the returning point is higher than 15 meters, the quadcopter will return back in the current altitude. If the returning point is lower than 15 meters, the quadcopter will rise to the 15 meter height and then to return back.

NOTE:1.In Return Home Mode, to make sure the GPS signal indicator light remain steady, it means that the signal is good.

- 2.It's suggested to switch to the Stable Mode first or until the quadcopter becomes stable to return back.
- 3.To turn the quadcopter to face the taking-off point before returning home, and to turn the quadcopter to the position while taking-off after it returns back.
- 4.After returning back, the quadcopter will lock automatically; if you need to restart the motor, please set the SWA to "0" position first and then to unlock the motors.
- (4) Flight Direction Lock Mode: While flying, to set SWA on the "1" position and SWB on the "1" position first. The forward direction will be as per what the head of the quadcopter goes toward when it is unlocked rather than as per what the head of the quadcopter is facing now, and the same analogy applies to other directions.

NOTE:1. This mode is not appropriate for the beginners, it needs more skills and experiences to do so.

- 2.In this mode, the quadcopter can return safely in long distance or in poor light.
- (5) Altitude Sensor Mode: After taking off in the Manual Mode, to set SWB on the "1" position and SWA on the "2" position, then to push the throttle stick to the altitude you want and to set the throttle stick to the middle position, the quadcopter will remain the current altitude constantly, and in the Altitude Sensor Mode, the quadcopter will fly in constant altitude.

NOTE:1. In Altitude Sensor Mode, the throttle stick needs to be in the middle position, it gives out "beep, beep, beep..."sound when the throttle stick is in the middle position in order for you to better control it.

- 2:Constant altitude is relative constant, it can move in a certain range depending on the speed of the wind and the weather, therefore you need enough safety space to fly it.

- (6) Return Home when the quadcopter is out of control: When the quadcopter is out of control, it'll turn into the Return Home Mode and return back and land in the position when it is unlocked automatically.
- (7) The cancellation of the Return Home Mode: In Return Home Mode and after the quadcopter returns to the areas in which it can be seen, if you want to stop the Return Home Mode, you need to do the following steps:
 - A: If the SWA is on the "0" position in the Return Home Mode, to set SWA on "1" position first and then to turn it back on "0" position, then the Return Home Mode is canceled.
 - B: If the SWA is on the "1" or "2" position in the Return Home Mode, to set SWA on "0" position first, then to turn it back on "1" position and then to turn it on "0" position again, then the Return Home Mode is canceled.

NOTE:1. It is suggested to use only Manual Mode, Stable Mode and One Key to Return Home Mode for the beginners, it means to use the SWA switch only;
 2. It is required to take off in the Manual Mode.

5 Low Voltage Protection for the quadcopter

- (1) Low voltage protection is a protection system designed to avoid the quadcopter to crash in low battery voltage. When the battery voltage is between 10.2V to 10.4V, the quadcopter will activate the low voltage alarm and give out the "beep, beep..." sound, and the front and rear indicator LED lights will blink at the same time.
- (2) There is 1-2 minutes to fly safely after turning into low voltage protection, therefore the pilots need to adjust the flying distance and to prepare to return safely.

6 Low Voltage Protection for the transmitter

- (1) Low voltage protection is a protection system designed to avoid the signal interruption for the transmitter in low battery voltage.
- (2) When the battery voltage is low, the transmitter will give out the "beep, beep..." sound, and the power indicator light will blink slowly at the same time.
- (3) Please change the battery in low voltage protection.

7 Frequently asked questions and solutions

Frequently asked questions	Solution
Fly in circle in Stable Mode	1. Poor GPS signal. To change to some other open places.
	2.2.To fly 3-5 minutes in Manual Mode, and it'll get the GPS signals automatically
Motors does not work	1.SWA switch is not set on the "0" position 2.Low battery voltage, please change the battery.
The quadcopter does not rise	To make sure the propellers are installed correctly, to reinstall the propellers if they are installed reversely
Does not return home accurately	Poor GPS signal. To change to some other open places.
The quadcopter can not hover	The quadcopter need to be recalibrated.

Dear customer:

Thank you for purchasing a Cheerson radio control aircraft product. In order to quickly and safely master the operation of the "CX-20", please read the user handbook carefully and then keep it in a safe place for future consultation and reference.

1 Important Statement

- (1) This product is not a toy. It is a piece of complicated equipment which harmoniously integrates engineering materials, mechanics, electronics, aerodynamic and high frequency radio. Correct installation and adjustment are necessary to avoid accidents taking place. The owner must always operate in a safe manner. Improper operation may result in serious property damage, bodily injury or over death.
- (2) We accept no liability for damage and consequent damage arising from the use of these products, as we have no control over the way they are maintained, used and operated.
- (3) This product is suitable for experienced Aircraft pilots aged 14 years or more. All minors must be accompanied by a responsible adult when flying.
- (4) The flight field should be legally approved by the local government. We accept no liability for any safety duties or fines arising from operation, usage or mis-control after the sale of the products.
- (5) We assign our distributors to offer technical support and service after sale. Please contact the local distributors for problem resolution caused by usage, operation, maintenance, etc.

2 Safety matters needing attention

Aircraft flight is a high risk hobby, whose flight should be kept far away from other people. Mis-assembled or broken main frame, defective electronic equipment, and/or problematic radio system will lead to unforeseen accidents such as bodily injury or property damage. The pilot MUST pay attention to the flight safety and UNDERSTAND his responsibility for accidents caused by his carelessness.

(1) Far away from obstacles and people

An Aircraft in flight has risk of uncertain flight speed and direction which is potentially dangerous. When flying, please keep your Aircraft far away from people, high buildings, high-tension lines, etc, and avoid operating in rain, storms, thunder and lightning.



(2) Keep away from humidity

Aircraft should be kept away from humidity and vapor because its complex, precise electronic components and mechanical parts may be damaged.



(3) Proper operation and maintenance

Please use Walkera original spare parts to upgrade, modify or maintain your Aircraft in order to ensure its safety. Please operate your Aircraft within the range of functions permitted. It is forbidden to use it outside of the safety laws or regulations.



(4) Avoid flying alone

At the beginning of learning about radio-controlled flight there are some difficulties to overcome. Please avoid flying alone. Invite experienced pilots to guide you (two of the most effective methods to practice are via a PC flight simulator and/or under the supervision of a skilled pilot).



(5) Safe operation

Please fly your Aircraft according to your physical status and flight skills. Fatigue, listlessness and mis-operation will increase the possibilities of accidental hazard.



(6) Away from highly spinning parts

Please keep pilot, people and object away from the spinning blades of both main rotor and tail rotor.



(7) Protect from heat

An Aircraft is made from metal, fiber, plastic and electronic components, etc. Please keep away from heat and sunshine in order to avoid distortion, even damage, caused by high temperatures.



3 Attention before flight

- (1) Ensure the battery packs of both transmitter and receiver are fully charged (saturated).
- (2) Ensure both the throttle stick and the throttle trim of your transmitter stay at the lowest positions before operation.
- (3) Please strictly obey the order of turn-on and turn-off before operation. When starting your flight, please turn on your transmitter first, and connect the power cable of your Aircraft last. When finishing your flight, please disconnect the power cable of your Aircraft first, and turn off your transmitter last.
- (4) An upset in the order of connection may cause your Aircraft to lose control. Please cultivate a correct habit of turn-on and turn-off.