

# A8 Operation Manual

(Suitable for operation in calm and light winds)

Suitable for 14 years old and above

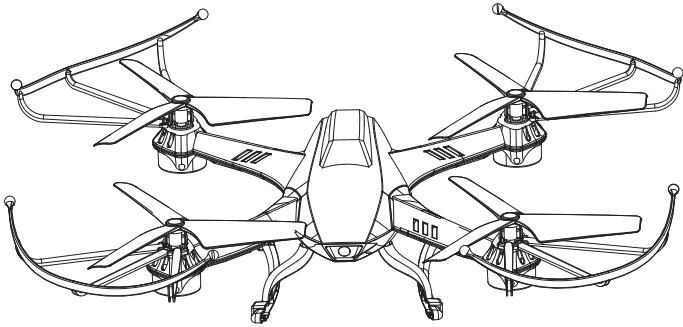

Get Assistance & Extended Warranty



Use camera or QR scanner to scan  
Or Visit: <https://attopafterservice.vip>

[www.attoptoy.com](http://www.attoptoy.com)

Customer Service Email : [attop@afterservice.vip](mailto:attop@afterservice.vip)

## 1. Package Contents

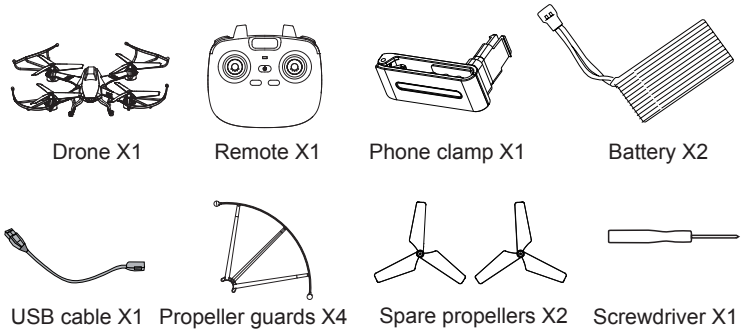

## 2. Charging

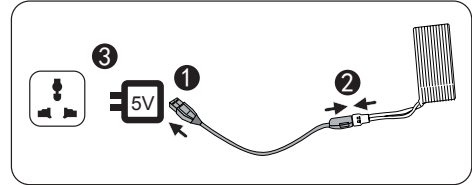

### Low battery warning

When the drone is flying, the indicator lights on the drone are flashing, and the remote control handle emits a "beep" alarm sound, indicating that the drone power is too low. At this time, the drone needs to return and charge.

### Charging Guide for battery

1. Connect the USB cable with power supply, the USB LED solid on, indicate the USB cable is power on.
2. Connect the battery with USB cable. When USB LED light is off, the battery is charging. When USB LED light is on, the battery is fully charged.

**!** Note: Use an power supply with standard output voltage 5V and current greater than or equal to 2A, otherwise there is a risk of overloading the USB cable and Battery. The flight time is about 10 minutes and the charging time is about 120 minutes.

## 3. Install

### (1) Landing Gears Installing

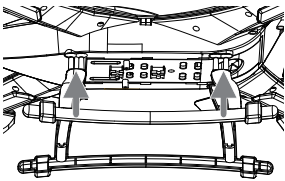

Install landing gears to specified position

### (2) Propeller Guards Installing

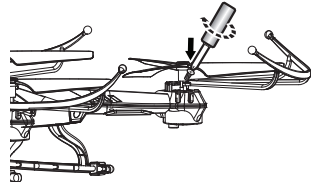

Install propeller guards to specified position

### (3) Battery Installing

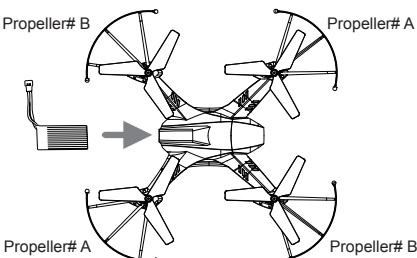

### Remote Controller

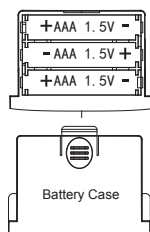

1. Insert the battery into specified position.
2. Connect the battery with drone.

Keep pressing the buckle of battery case then pull the case to take it out, insert 3xAAA battery into specified position.

### (4) Phone clamp installing

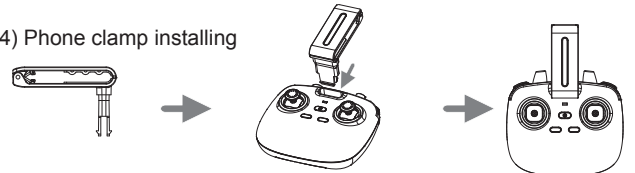

Put the phone clamp to specified position on the remote, and make sure to fasten the phone clamp.

## 4. Remote Controller

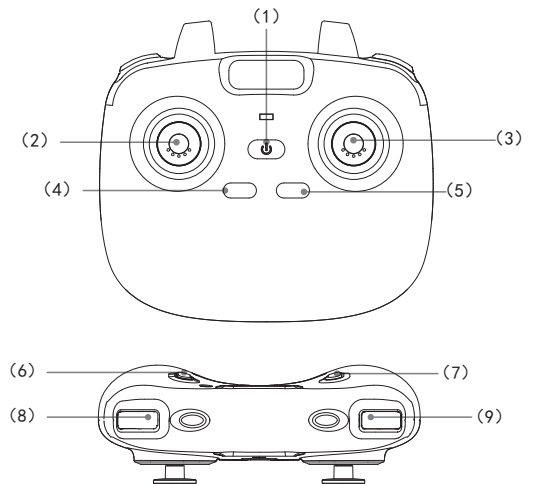

- |                                    |                           |
|------------------------------------|---------------------------|
| (1) Power switch                   | (5) Right function switch |
| (2) Left joystick                  | (6) Take photo            |
| (3) Right joystick                 | (7) Video                 |
| (4) Left function switch           | (8) Speed switch          |
| (Take off/Landing, Emergency stop) | (9) 360° Stunt            |

## 5. How To Fly

### (1) Switch On the Power

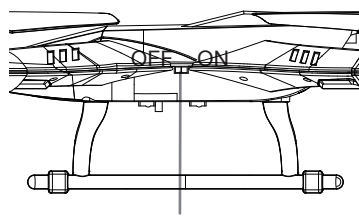

① Power on the drone.

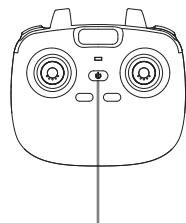

② Power on the Controller.

### (2) Pairing

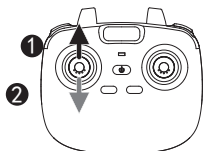

(Pic 1)

After Powering On the drone, both indicator lights on the Drone and Remote are flashing, then push the Left Joystick to the top, and then down to the lowest (Pic 1). After 2 secs, the indicator lights are turning solid, that means the pairing succeeds.

### (3) Gyroscope Calibration

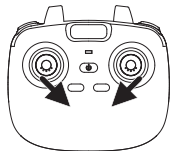

(Pic 2)

Push Left Joystick to right corner and Right Joystick to left corner at the meantime (Pic 2). The indicator lights of the drone are flashing rapidly for about 3 seconds. The The indicator lights are turning solid when completed.

4

### (4) Activate motors for taking-off

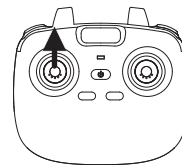

After pairing, push the Left Joystick to the top then release to activate motors, then the propellers start rotating.

### (5) Take off / Landing

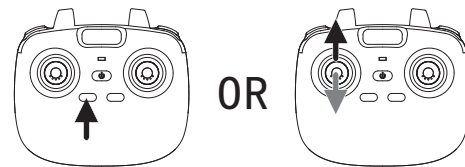

Take off: After activating motors, press "Left function switch" (or push up the Left Joystick slowly) to take off.

Landing: When the drone is in the air, press "Left function switch" (or keep pushing down the Left Joystick slowly) to land.

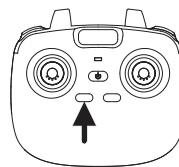

### ⚠ Emergency Stop

In case of emergency status, keep press "Left function switch" about 3 seconds, the drone will immediately stop functions and drop off.

5

## 6. Using the Remote Controller

Left Stick

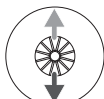

Up / Down

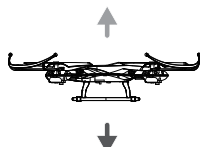

Right Stick

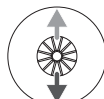

Forward / Backward

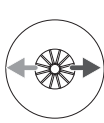
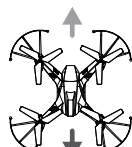

Turn left / Turn Right

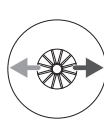

Left-sideward / Right-sideward

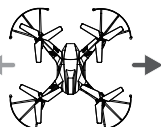

## 7. Aircraft Functions

Adjustment for deviated flying to Front/Backward

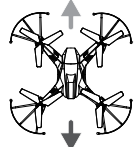
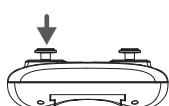

Vertically press Left Joystick for activate adjustment function.

If it leans forward, push Right Joystick to backward.

If it leans backward, push Right Joystick to forward.

Vertically press Left Joystick again for deactivate adjustment function, after finished adjustment.

Adjustment for deviated flying to Sideward

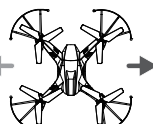
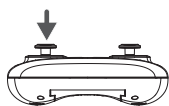

Vertically press Left Joystick for activate adjustment function.

If it leans right sideward, push Right Joystick to left side.

If it leans left sideward, push Right Joystick to right side.

Vertically press Left Joystick again for deactivate adjustment function, after finished adjustment.

6

### 360° Stunt Function

①

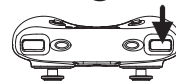

②



1. Press the 360° Stunt

2. Push the stick to right, the drone will rotate 360° toward right direction

①

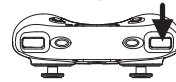

②

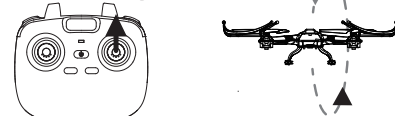

1. Press the 360° Stunt

2. Push the stick to top, the drone will rotate 360° toward front direction.

①

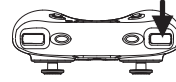

②



1. Press the 360° Stunt

2. Push the stick to left, the drone will rotate 360° toward left direction.

①

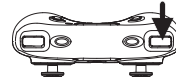

②



1. Press the 360° Stunt

2. Push the stick to bottom, the drone will rotate 360° toward back direction.



Note:

\* There are continuous beeps from the remote when you activate this function. If you do not move the Right Joystick about 5 seconds after you press the 360° Stunt switch, the function will be cancelled and the remote will stop beeping.

\* This function can't be activated when the battery of the drone is low.

7

### Speed Adjustment

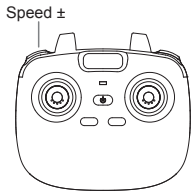

Press the speed switch to change the speed gear while flying. There are 3 gears, press the Speed switch, you will hear "beep, beep", means it is on the second gear speed. Press again, you will hear "beep, beep, beep" means it is on the third gear speed. Press again, you will hear "beep" means it is back to the first gear.

**Remark: Beginners would be suggested to use the first gear speed firstly to play until skillful.**

### 8. Return-to-home function

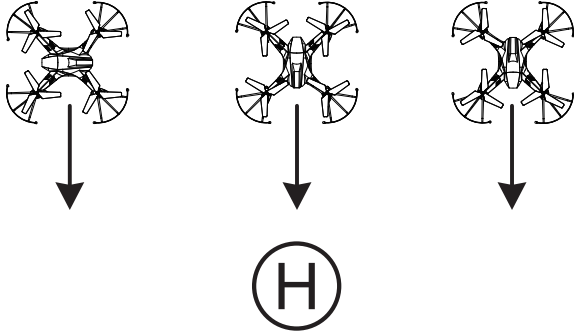

In regular mode, when the drone fly forward, stand and make sure the remote toward the tail of drone then press the "Right function switch" to activate headless mode, no matter which direction that the drone heading to, keep pressing the "Right function switch" about 3 seconds, the drone would fly straight back to remote location.

Note : 1. The drone will not land itself when operate this function, just fly straight toward the remote direction, negative direction operate the right stick to stop flying.

- If you change your position while playing, Return-to-home function will be inaccurate. Now turn the drone's tail toward the remote, then press the "Right function switch" to activate headless mode, and keep pressing the "Right function switch" about 3 seconds, then It will come back successfully. Or you can also face to the drone's tail and calibrate the gyroscope after it lands. Such operation is to update the drone's return direction.

### 9. Headless Mode Function

Press the "Right function switch". When the indicator lights are slowly flashing, the drone is in Headless Mode.

Press the "Right function switch" again. When the indicator lights stop flashing, the Headless Mode is deactivated.

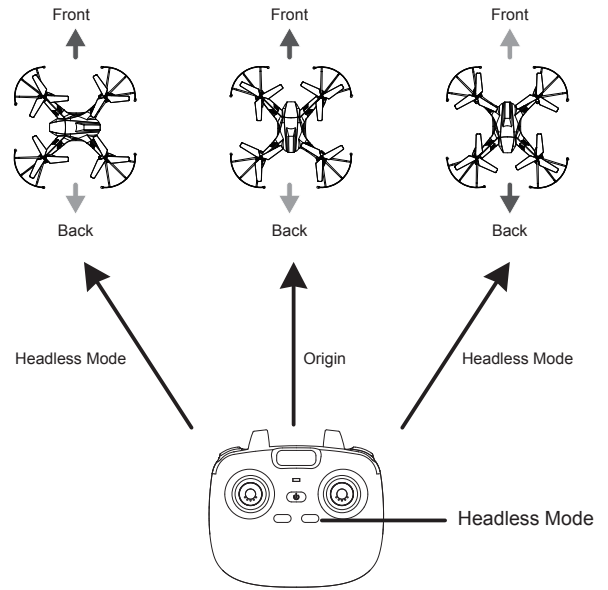

Users are recommended to stay same orientation as the drone head is facing when the drone takes off.

Headless Mode, the forward direction is same as the direction when the drone took off, where the head of drone was facing.

In order to make sure the users can clearly identify drone's direction, we suggest that users better stay in the same orientation as the drone facing when it takes off.

Then no matter which direction the head is facing, the drone will lock the controlled direction as the remote controller, easy to control back the drone.

### 10. Photograph and Video

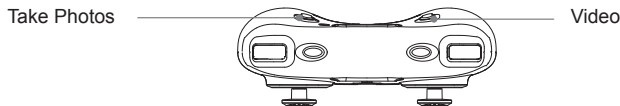

**Take Photos:** Press the button of "take photo". Please make sure to open the app on your smart phone before using it, then you can review the photos taken in the media file of app.

**Video:** Press the button of "take video", press to start and press again to finish and save the video. Please make sure to open the app on your smart phone before using it, then you can review the videos taken in the media file of app.

### 11. Aircraft Parameters

Propeller dia.:	100mm
Aircraft:	301X301X70mm
Total weight:	90g±2g
Battery:	3.7V950mAh
Charging time:	About 120 mins
Flight time:	10 mins
Gyroscope:	Built-in
Working temperature:	-10°C to 40°C
Remoter controller:	2.4G
Motor:	8*26 4pcs

#### Remote Controller Parameters

Effective Control Range:	50 meters
Wifi Transmission Range :	30-40 meters
(in a wide open area with no electromagnetic interference)	
Working frequency:	2.4G
Battery:	3xAAA

### 12. FAQ

	ISSUES	CAUSE	SUGGESTIONS
1	After the battery is inserted in the drone, indicator lights on drone keep flashing, no response to operations	Frequency matching between remote and receiver not successful	Reoperate the frequency matching for remote and drone (please refer to P.4 for details)
2	No response after battery is inserted in the drone	1. Check if the power for remote and drone is full charged. 2. Connection of the poles are not good	1. Open the remote battery case and make sure if the battery is inserted in right position 2. Use a fully charged battery 3. Reinstall the battery and confirm whether it is good connecting with the poles well.
3	Motor does not run when operating the throttle stick and the indicator lights on drone keep flashing	Power for the Li-Poly battery is not enough	Charge the battery or replace it with a full-charged battery
4	Main motor blades spin but the drone won't fly	1. Some of the blades have been deformed 2. Battery power is not enough	1. Replace the main blade 2. Charge the battery or replace it with a fully charged battery

# 13. Battery Using Attention

## Matters needing attention

- Rechargeable batteries are to be removed from the toy before being charged.
- Non-rechargeable batteries are not to be recharged.
- Rechargeable batteries are only to be charged under adult supervision.
- Only used to charging 2S Li-ion or Li-polymer battery pack. if not, the charger or battery may be damaged .
- During charging, the charger should be put in dry and ventilated place and far away from heat source and inflammable and explosive substance.
- Never immediately charge your battery pack as soon as the flight is finished, or when its temperature doesn't cool down. Otherwise the battery will take a risk in swelling, even a fire.
- Ensure the correctness of polarity before connection the battery to charger.
- Avoid drop and violence during the process of charging. drop and violence will result in internal short circuit of the battery.
- For the sake of safety, please use original charging equipment and battery pack . please change new one in time when the flying time is becoming shorten due to long time usage .
- If it is retained in the charger for a long time after saturated, the battery may automatically discharge. When the charger detects that the voltage of individual cells is lower than the rated voltage, it will re-charge until saturated. Frequently charging and discharging will shorten the lifetime of your battery pack. It is advised that please cut off the power and took off the battery after the charging is saturated.

## Maintenance of battery pack

- The battery pack should be put in dry and ventilated place. The storage temperature of environment is ranged from 18°C to 25°C.
- Please avoid frequent charging and excessive discharging the battery pack in order to prolong its life cycle.
- It is a must to maintain the battery pack before long-term storage. That is to charge the battery to the level of 50-60% saturation.
- If the storage term is over 1 month, it is advised to monthly check the voltage of every cell of the battery pack. The voltage of every cell should be not less than 3V. Otherwise, please refer to the above article (3).
- From the view point of protection, new battery pack should be motivated before usage. That is to charge and discharge 3-5 times, but discharge is not less than the level of 70% saturation. This process will make the battery lifetime longer and voltage more stable.

# 14.Disclaimer

Please read this manual carefully before using our product. This product is not recommended for people under the age of 14. By using this product, you hereby agree to this disclaimer and signify that you have read it fully. You agree that you are responsible for your own conduct and any damage caused while using this product, and its consequences. You agree to use this product only for purposes that are proper and in accordance with local regulations, terms and all applicable polices and guidelines ATTOP may make available.

# SAFETY AND PRECAUTIONS

	<p>Remote-control models of quadcopter are dangerous merchandise. Their flight must be operated away from the crowd. Such factors as man-made improper assembly or mechanical damage, poor control of the electronic equipment, as well as the unfamiliar manipulation may lead to unexpected flight accidents, such as uncontrolled flight and aircraft damage. Users are advised to pay attention to the flight safety and understand that they are held responsible for any accident caused by negligence.</p>
	<p><b>Special drone for Indoor and outdoor should stay away from barriers</b></p> <p>This product is a remote-control drone, that suitable for in indoor using and outdoor environments (the outdoor wind power less than Force 2). To fly this drone, please choose appropriate obstacle-free indoor and outdoor sites with proper distance kept from the crowd or pet animals. Please don't operate the product in any unsafe environments, such as places of heat, wires, power supply, etc., so as to prevent the quadcopter from the risks of fire and electric shock resulting from collision, ditching, and entangling of the drone.</p>
	<p><b>Safe usage of the lithium battery</b></p> <p>Lithium batteries are more dangerous than others. Be sure to read carefully and follow the following precautions before using it. We will not be held responsible for any damages caused by any improper use of the battery. To avoid the danger of explosion or fires, it is forbidden to use other chargers than the one made by our factory. Such actions done to the battery as impact, dismantling, reverse connection of the positive and negative poles, and burning are forbidden. Avoid metal objects from contacting the positive and negative poles of the battery, which may cause short circuit. Please prevent sharp items from piercing the battery, and avoid the risk of battery fire. Please be careful when charging the battery. Make sure that the battery is charging within your sight. Keep it out of the reach of young children so as to avoid dangers. Don't charge the battery when the battery is heated after use. Otherwise, it may cause the battery to expand, change, explode or even catch fire, threatening the safety of life and property. To dispose of the battery, please recycle the battery in strict compliance with the waste disposal laws and regulations of local countries or regions in order not to pollute the environment.</p>
	<p><b>Away from moist environments</b></p> <p>The interior of the aircraft is also composed of many sophisticated electronic components so it must absolutely be kept away from moisture or water vapor. Don't operate the aircraft in the bathroom or on rainy days; otherwise water vapor may get inside of the aircraft and cause mechanical parts and electronic components to malfunction leading to expected accidents.</p>
	<p><b>Never misuse the product</b></p> <p>Please do not disassemble or modify the product. For any upgrade, repair or maintenance, please use the parts specified in our catalog to ensure the safety of the structure. Please make sure the product is used within the limits of operation. Don't overload the product, and don't use it in any other illegal ways than prescribed by safety concerns and laws.</p>

<p><b>Safe usage of the battery</b></p> <p>Batteries are to be inserted with the correct polarity. The supply terminals are not to be short-circuited. Different types of batteries or new and used batteries are not to be mixed. The exhausted batteries are to be removed from the toy. For long time storage, please take them out to prevent battery leakage. Please dispose abandoned batteries in accordance to the laws and regulations of the corresponding region to prevent pollution to the environment.</p>	
<p><b>Keep away from source of heat</b></p> <p>The aircraft is mostly made of PA fiber or polyethylene as well as other main materials for electronic products. Therefore, it must be kept from the source of heat and exposure to sunlight so as to avoid possible damage of deformation or even meltdown due to high temperatures.</p>	
<p><b>Never operate the product alone</b></p> <p>This product is suitable for users over 14 years old. Since the remote-control quadcopter may pose a certain degree of difficulty for learners at the beginning, it is recommended for it to be operated under the guidance of experienced people for the sake of safe flight.</p>	

# Description of WIFI Live Stream Camera Version

## How to connect the WIFI Signal



Available on the App Store



Google play



(PIC.1)

- Download the app: from App Store / Google Play.
- Power on the drone.
- Go to the WIFI setting on phone/device, choose the WIFI signal of the drone (A8-AM+No.) , and connect it.
- Now open the App of the drone, then select the Language "EN" (Pic.1).
- Select the item and click "Connecting devices".

Attention: When the drone has low power, it might unable to be connected successfully.



- |                             |                               |
|-----------------------------|-------------------------------|
| 1. Gesture to take pictures | 17. Ascend                    |
| 2. Background Music         | 18. Descend                   |
| 3. Speed mode: 30%,60%,100% | 19. Turn Left                 |
| 4. 360° Stunt               | 20. Turn Right                |
| 5. Headless mode            | 21. Left Joystick             |
| 6. Gravity Control          | 22. Forward/Backward trimming |
| 7. Path Plan                | 23. Forward                   |
| 8. Voice Control            | 24. Backward                  |
| 9. VR Mode                  | 25. Left sideward             |
| 10. Home page               | 26. Right sideward            |
| 11. On/Off for interface    | 27. Right Joystick            |
| 12. Take video              | 28. Sideward trimming         |
| 13. Take picture            | 29. Emergency Stop            |
| 14. One key take off        |                               |
| 15. One key landing         |                               |
| 16. Calibration             |                               |

## Operation way

### Control with your device.



(PIC. 2)

1. After connecting the WIFI signal and entering into the app interface, press the "on/off button" (11) to open it.
2. Wait 2 seconds then lights of drone stop flashing, then press the "Calibration button" (16) to calibrate the drone if first time play.
3. Push the left throttle up to top, and then the rotors of the drone start rotating, that unlock the motors. (see Pic 2).
4. Press the "One key take off" (14) to fly up the drone (or push up the throttle directly), then play.  
Press the "One key landing" (15) (or keep pushing down the throttle directly) to land the drone.
5. Press the "Video" button (12) on interface, to take video.  
Press the "Picture" button (13) on interface, to take picture.  
After taking you can review the files from the "Gallery" in Home page, or from your album file of your device.

### Control with the remote controller

1. Power on the drone and power on the controller, after pairing between the controller and drone (the lights of the drone and controller are turning solid), then connect the WIFI signal between your device and the drone.

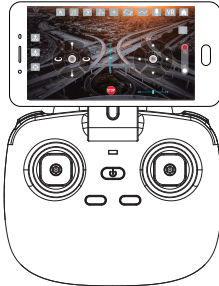

2. Put the device to the clamp of the controller, then click "Connecting devices".
3. Press the "Picture" button on interface or on controller, to take picture.

Press the "Video" button on interface or on controller, to take video.

After taking you can review the files from the "Gallery" in Home page, or from your album file of your device.



### 30-Day Whole Unit Warranty For Quality-Related Issue

For 30 days after the date of purchase, we take care of all quality-related issues with a REPLACEMENT.

Reminder : Be sure to operate your drone as directed.

### 90-Day Accessories Warranty For Any Reason

For 90 days after the date of purchase, we take care of all accessories quality-related issues with an ACCESSORY REPLACEMENT.

Reminder: Be sure to maintain your drone as directed.

Name of App :  W FPV

Apply to IOS \ Android system (Note: Apply to Android 2.3 or above such as SAMSUNG, SONY, HUAWEI and etc.  
But cannot guarantee the phone of other brands with Android system could operate stably.)