



ATOYX Quick Start Guide

Step1
Turn on Power

Step2
Unlock (Push Throttle up and pull down)



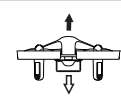
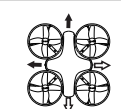

Step3
Ascent/Descent (Push throttle)

Step4
Direction Lever

ATOYX Features

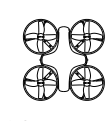
- Altitude hold
- Headless mode
- 3 Speeds adjustment
- 3D stunts
- 7 Color led cycling
- One key return
- Built in 6-axis gyroscope, fully stability

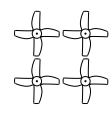
ATOYX Standard components

1x Quadcopter 1x Remote controller 1x USB cable 4x Blades 1x User manual

ATOYX Battery charging and install

Battery charging

Plug the charging cable to a USB charging port.

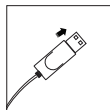
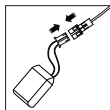
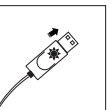
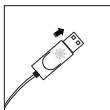
Connect the battery with the USB charging port.

The indicator displayed means during charging status.

After charging finished, the indicator will off.

=1=

Battery install

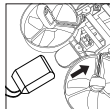
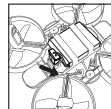
Insert the battery and connect the cable.

After powered, the led light will keep blink.

Caution

LED indicator		Charge specifications		
light off ○	light on ☀	input	charging current	full voltage
charge completed	charging	5V	420-450mA	4.2V ± 0.03V

Battery and charge specification			
battery type	battery specification	usage duration	charge time
Lithium batteries	3.7V 220 mAh	aircraft flight time	about30-50mins(charging current approx 0.5A)

ATOYX Remote control function key description

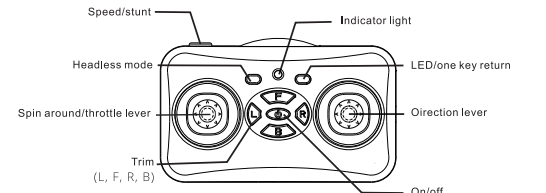

ATOYX Replace blades

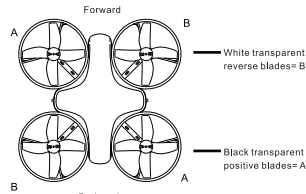

White transparent reverse blades = B











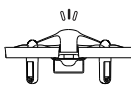
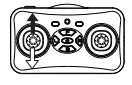

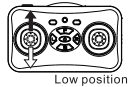
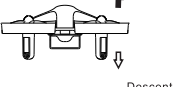
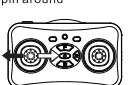
Black transparent positive blades = A

Please check the blades regularly, once damaged please replace with new one.

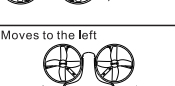
- There are four blades in the Drone, two transparent in the front.
- When replacing the blades, make sure the color and direction are matched.(F is for positive blades, R is reverse blades)
- Important: do not change the wrong blades

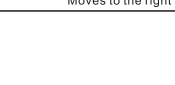





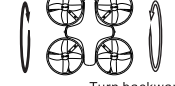

=2=

ATOYX Remote control instructions

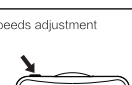
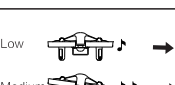
Turn on/off 	Blink 	Powered on: After 2 AAA battery installed and long press on/off button, will send out a "bi" sound, and the led light keep blink then means power on. Powered off: Long press on/off button, the buzzer will "bi" "bi" twice, after the led light off then means the power off.
Unlock 	Light stable 	Unlock: After both remote controller and drone powered on, push the throttle lever to maximum and the pull to minimum, the led light changed from blink to stable lighted meantime means unlocked.
Throttle (Top position) 	Ascent 	Push the throttle lever up, drone will fly up.
Low position (zero position) 	Descent 	Push the throttle lever down, drone will fly down.
Spin around 	Turn left 	Push the throttle lever to left, drone will turn left.
	Turn right 	Push the throttle lever to right, drone will turn right.
Flight forward and backward 	Fly forward 	Push the direction lever up, drone will fly forward.
	Fly backward 	Push the direction lever down, drone will fly backward.
Left and right side of the fly 	Moves to the left 	Push the direction lever left, drone will fly left.
	Moves to the right 	Push the direction lever right, drone will fly right.

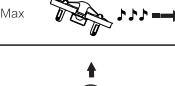
=3=

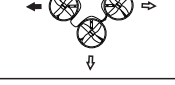
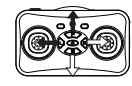
ATOYX

Long press the "Flip" button, the controller will beep. 	Turn forward 	Long press the roll button, do not release the remote control to make a "bi..." sound while pushing the direction bar. Front flip: move direction lever forward. Back flip: move direction lever backward.
Long press the "Flip" button, the controller will beep. 	Turn left 	Long press the roll button, do not release the remote control to make a "bi..." sound while pushing the direction bar. Left flip: move the direction lever left. Right flip: move the direction lever left/right.
3 speeds adjustment 	Low 	Short press speed/stunt button switch speed. 1 speed (low speed): "bi" 1 time 2 speed (medium speed): "bi" twice 3 speed (high speed): "bi" 3 times Recommended for beginners to use 1 speed (low speed) at first.
Headless mode 		Press headless mode button, the headless mode will start up. The drone direction will follow the remote controller, not depend on nose direction.
Trim 		Press L,R,F,B button could fine tuning flight path.
One key return 		Long press Led/one key return button could make the drone return fast.

=4=

ATOYX Calibrating the drone

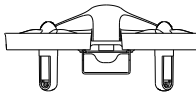

Horizontal surface

Step one

Turn on the controller and the drone power. Put the drone in a flat surface, once you heard a "beep" sound, pair is completed.

Importance: Please always put your drone in a flat surface.

Step two

After pairing, move the throttle to the right corner, hold this until the drone's LED flash about three seconds, calibration is completed when LED turns solid bright.

WARNING

Please take out the battery when the drone is not in use. Note: It may cause damage to controller if battery is not removed.

ATOYX Trouble shooting

	Troubles	Causes	Ways to deal
1	Drone does not respond	Pairing failed between control and drone	Syncing remote controller and aircraft(refer to P3)
2	Drone does not respond	No battery	Recharge
3	Blades keep moving after landing	Throttle stick not on the lowest position	Make sure the throttle stick is on the lowest position
4	Drones can not take off	1,Blades installed wrong 2,low battery	1,Check and replace the main rotor 2,Recharge
5	Blades moving speed is different after trim	1,blades wrong installed 2,Blades get damaged 3,Calibration failed	1,Blades are not installed well 2,Replace the blades 3,Calibration the drone refer to P5
6	Drone can not fly after drop	1,Blades get loosed 2,Blades get damaged	1,Tighten the blades 2,Replace the blades

=5=

MADE IN CHINA
AT66IMEN05

ATOYX

Important statement

- Features
Standard components
Battery charging and install
- Remote control function key description
Replace blades
- 4 Remote control instructions
- Calibrating the drone
Trouble shooting

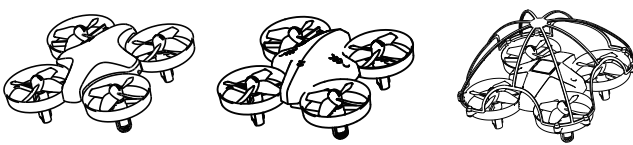

Model: AT-66 AT-66C AT-66D

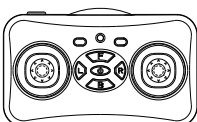

One controller supports multiple drones

USER'S GUIDE