

FCC Part 15 C Notice

CAUTION: Changes or modifications not expressly approved by the party responsible for compliance could void the user's authority to operate the equipment.

NOTE: This equipment has been tested and found to comply with the limits for a Class B digital device, pursuant to Part 15 of the FCC Rules. These limits are designed to provide reasonable protection against harmful interference in a residential installation. This equipment generates, uses and can radiate radio frequency energy and, if not installed and used in accordance with the instructions, may cause harmful interference to radio communications. However, there is no guarantee that interference will not occur in a particular installation. If this equipment does cause harmful interference to radio or television reception, which can be determined by turning the equipment off and on, the user is encouraged to try to correct the interference by one or more of the following measures:

- Reorient or relocate the receiving antenna.
- Increase the separation between the equipment and receiver.
- Connect the equipment into an outlet on a circuit different from that to which the receiver is connected.
- Consult the dealer or experienced radio/TV technician for help.

This device complies with Part 15 of the FCC Rules. Operation is subject to the following two conditions :

- (1) This device may not cause harmful interference, and
- (2) this device must accept any interference received, including interference that may cause undesired operation.

FCC RF exposure statements

This Transmitter must not be co-located or operating in conjunction with any other antenna or transmitter. This equipment complies with FCC RF radiation exposure limits set forth for an uncontrolled environment. This equipment should be installed and operated with a minimum distance of 20 centimeters between the radiator and your body or nearby persons.

Conforms to safety requirements of FCC.

Ascend Aeronautics™ is the registered trademark of AMAX Industrial Group LTD.

AMAX Group USA Address: 12645 Memorial Dr Suite F1 #388 Houston, TX 77024

© 2021 All Rights Reserved. visit us at www.amaxbrands.com

Distributed by:
Costco Wholesale Corporation
P.O. Box 34535
Seattle, WA 98124-1535
USA
1-800-774-2678
www.costco.com



Made in China
CT-6333
C009-USA-V1.0

ASC-2400

HD VIDEO DRONE



INSTRUCTION BOOKLET

WARNING: Never leave your drone charging unattended for extended periods of time. Always disconnect the battery from charger immediately after the battery is fully charged. Please refer to the enclosed safety instructions.

PACKAGE CONTAINS:

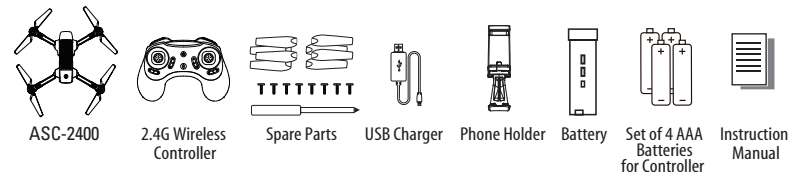

Colors and styles may vary slightly from photos

TABLE OF CONTENTS

Features	2
Remote Control Battery Installation	2
Charging The ASC-2400 Li-Poly Battery	2
Installing The ASC-2400 Battery	2
How To Expand And Fold Your ASC-2400 Arms	2
ASC-2400 Diagram	3
Control Diagram	3
Flight Preparation	4
Syncing Your ASC-2400	4
Now You Are Ready To Fly	5
Recognizing The Front & Rear Of The ASC-2400	5
Starting & Stopping The Rotors	5
Auto Start / Auto Land	5
Manual Start/Stop	5
Speed Select Button	5
Flight Control	6
Flight Practice	6
Adjusting The Trim	7
Calibrating The ASC-2400	8
How To Perform 360° Stunt Rolls	8
Installing Your Phone Holder	9
Camera Video And Photo Streaming Setup	10
Troubleshooting Your ASC-2400	11
Replacing The Propeller Blades	12
Warnings	13
Battery Warnings	13
Care And Maintenance	13
Limited 90-Day Warranty	14
FCC Information	15

Thank you for purchasing the ASC-2400 Drone. Please read this instruction booklet as it contains valuable information on how to properly fly and care your ASC-2400.

FEATURES

- Streams video and still Images directly to your mobile device
- Push button Auto Start, Hover, and Auto Land technology
- Built-in 6 Axis Gyro + Altitude Sensors for incredibly stable flight
- High Efficiency Li-poly battery extends drone flight time*
- "Go-Anywhere" Folding Frame design for easy transportation

REMOTE CONTROL BATTERY INSTALLATION

1. Unscrew and remove the battery cover from the back of the controller.
2. Install 4 AAA alkaline batteries into the controller as shown in diagram A. Replace the battery cover and secure it.
3. Turn over the controller front side up and press the power button. If you hear two beeps and the power indicator light turns on, you have installed your batteries correctly.

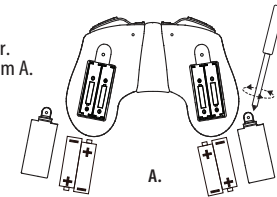

4×1.5 volt "AAA" Alkaline Batteries (included)

CHARGING THE ASC-2400 LI-POLY BATTERY

1. Insert the USB charger into the battery charging socket (see diagram B).
2. Connect the USB end of the cable to your computers USB port or a USB wall charger (see diagram C).
3. A red LED indicator light will illuminate while charging and then turn off when charging is complete.
4. Average charging time is approximately 130-150 minutes (via 5.0V==2A USB wall charger). A fully charged ASC-2400 can fly for 15-18 minutes depending on environment and user input.

IMPORTANT: ALWAYS REMEMBER TO UNPLUG YOUR CHARGING CORD WHEN NOT IN USE!

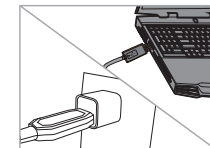
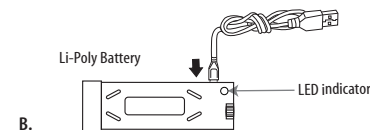

INSTALLING THE ASC-2400 BATTERY

Carefully Push the fully charged battery into the ASC-2400 battery compartment all the way in until it stops and is flush with back of the drone (see diagram D).

NOTE: The battery only fits one way into the battery compartment. Never force it.

HOW TO EXPAND AND FOLD YOUR ASC-2400 ARMS

Before flying your ASC-2400, you need to expand the foldable arms out.

1. Make sure the drone power is turned off.
2. Holding the folded ASC-2400 drone in the palm of your hand (see diagram E) proceed to open the arms by starting with the Front Arms (Upper Arms) and then Rear Arms (Lower Arms)
3. Make sure the arms are fully extended and locked into place (see diagram F). Note you will feel some additional pressure indicating the arm is properly locked into place.
4. When folding in the arms simply reverse steps 1-3 above.

NOTE: Never use hard force when opening and closing the ASC-2400 Arms

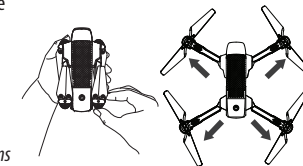
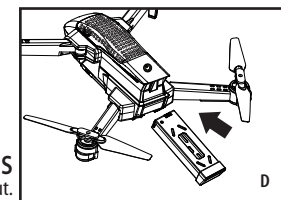

ASC-2400 DIAGRAM

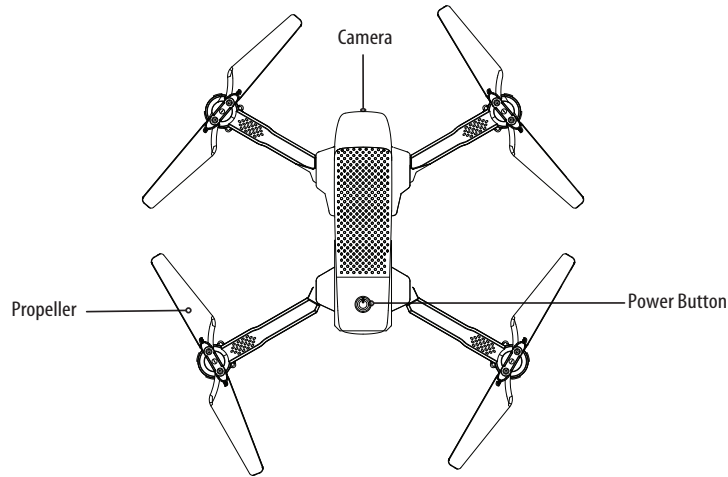

CONTROLLER DIAGRAM

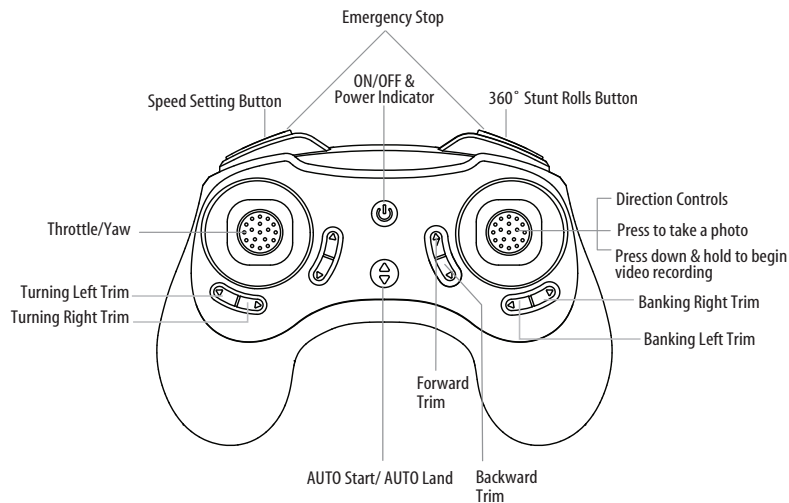

WARNING

DO NOT FLY YOUR ASC-2400 IN FOUL WEATHER!



FLIGHT PREPARATION

- Verify that there are 4 "AAA" batteries inside the remote control unit and the ASC-2400 Li-poly battery has been fully charged.
- Make sure to be in a large open space preferably a field or a park with an open radius of at least 200 feet.
- Make sure to start your drone on a clean flat level surface before take-off.
- **IMPORTANT! Until you have experience in flying your ASC-2400, it is not advised to use in any rate of wind. Pick a day with zero wind or extremely light wind condition when learning how to fly.**

SYNCING YOUR ASC-2400

Important! When syncing your ASC-2400 with the controller always make sure that the drone is on a flat level surface and that your digital trim settings are in the center position.

1. Before starting, make sure that the power on your controller is off and the battery is removed from the ASC-2400.
2. Insert the battery into the ASC-2400 and set it down on a flat level surface. Press down the power button and hold for a few seconds (see diagram G). The red LED lights on the drone should begin to flash rapidly first and then flash slow.
3. Quickly turn ON the remote and you will notice that the top red LED light on the face of the controller is flashing.
4. Push the throttle stick all the way up until it stops and then pull it back all the way down to the bottom (see diagram below). When pushing the stick up or pulling the stick down you should hear a high-pitched beep both ways. If the indicator lights on the drone and controller stop flashing and stay solid, you have successfully synced your ASC-2400 and are ready to fly. If you are not able to Sync, please repeat steps 1-4 again.

- **TIP 1: Try not to leave too much time between turning your drone on and turning on the controller, or your syncing window will time-out.**
- **TIP 2: Syncing your drone indoors or in the shade will make it easier to see the LED light indicators.**

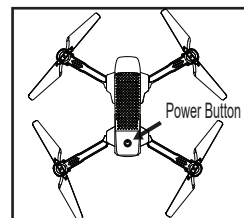

G

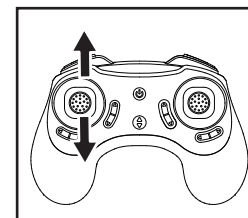

Move the control stick all the way up and all the way down, you should hear two beeps.

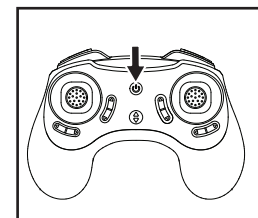

The flashing red LED light will become solid when you are synced.

NOW YOU ARE READY TO FLY!

If you have successfully synced your ASC-2400 to your controller as explained on page 4 you are now ready to fly. Before beginning to fly your drone you should familiarize yourself with how to start and stop the rotors, how to use your auto land feature and how the controls work. Please carefully read and familiarize yourself with the various control features explained in the instruction manual. Once again as a beginner pilot you should learn how to control your drone in a large open field or park on a day with zero or very light wind. Do not try to fly your ASC-2400 too high until you become a more experience pilot.

RECOGNIZING THE FRONT & REAR OF THE ASC-2400

Even though the ASC-2400 has four rotors there is still a front or "forward" facing direction and "rear" or backwards facing direction. The front forward facing direction of the ASC-2400 is the side with a camera. The rear and backward facing direction of the drone is the side with a red light (see diagram H).

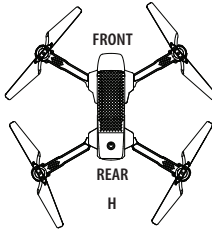

STARTING/STOPPING THE ROTORS

Note: You can start and stop your ASC-2400 Manually or Automatically. Please follow one of the steps below to operate accordingly. Make sure you have properly synced the ASC-2400 drone which is indicated by a solid red light on both the controller and the drone.

AUTO START/AUTO LAND

The ASC-2400 has an auto start/auto land feature which allows you to start and land automatically. Simply press the auto **START/LAND** button on the face of the controller (see diagram I) and your ASC-2400 will begin taking off or land (if you already in the air).

NOTE: You can still control the drone's direction while auto ascending or auto-landing if necessary to avoid obstacles.

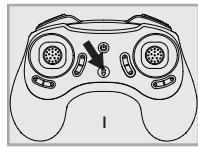

MANUAL START/STOP

- To Manually start the rotors simply move the two control sticks simultaneously down to the inside or outside corners (see diagram J), hold until the rotors start spinning. Now release both sticks to the neutral position and push the throttle up to take off.
- To manually stop the rotors you can: a) simply land on the ground and the Rotors will automatically stop in ten seconds or less. b) You can immediately stop the rotors by moving the two control sticks simultaneously down and to the inside or outside or outside bottom corners (see diagram J) or c) **EMERGENCY STOP:** you can make an emergency stop by depressing both the **SPEED** button and the **STUNT** button simultaneously (see diagram K).

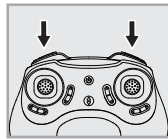

SPEED SELECT BUTTON

The ASC-2400 has 3 speed settings; 1 (SLOW), 2 (MEDIUM) and 3 (HIGH). The Default setting when you first turn on your ASC-2400 is the 1 (SLOW) speed mode. To increase the speed simply press the speed setting button on the top of the remote (see remote diagram on pg 3) you will hear beeping sounds letting you know what speed setting you are on. Speed settings can be set before flight or during the flight.

FLIGHT CONTROL

Below is a list of basic flight inputs/functions that will help you learn to fly the ASC-2400. While learning to fly your drone it's best to start in a large space with the drone facing away from you until you get used to the basic controls. As you master flying your ASC-2400 you can move to more advanced maneuvering techniques. Practice makes perfect!

Move the left throttle stick up to increase the propeller speed and the ASC-2400 will ascend. Move the left throttle stick down to decrease the propeller speed and the ASC-2400 will descend (see diagram L).

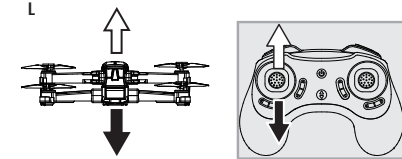

While in the air, move the left throttle stick directly left and the ASC-2400 will rotate horizontally left (counter clockwise). Move the left throttle stick directly right and the ASC-2400 will rotate horizontally right (see diagram L1).

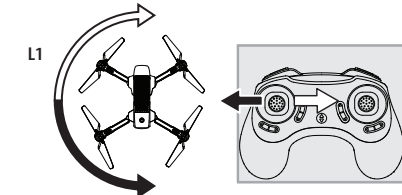

While in the air, move the right direction control stick forward and the ASC-2400 will move forward.

Move the right direction control stick backwards and the ASC-2400 will move backward (see diagram L2).

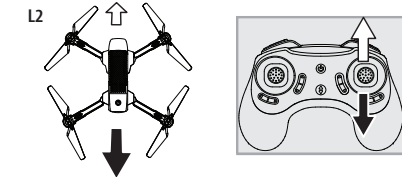

While in the air, move the right direction control stick to the left and the ASC-2400 will bank/sweep to the left.

Move the right direction control stick to the right and the ASC-2400 will bank/sweep to the right (see diagram L3).

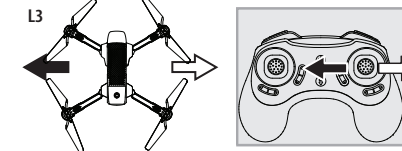

FLIGHT PRACTICE

To master flying your ASC-2400 drone try practicing the exercises shown below, start with simple vertical takeoffs, landings, and left/right turning and rotating. Once those are mastered move on to square and cross maneuvers. Good luck and have fun!

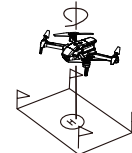

Fixed-Point Landing

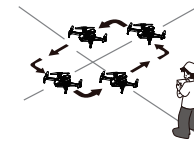

Square Pattern Maneuver



Cross Pattern Maneuver

ADJUSTING THE TRIM

NOTE: The ASC-2400 is already properly trimmed and calibrated right out of the box and should not require any trim adjustments before flying. Some more experienced pilots may want to adjust trim settings for their style of flying. After several crashes you may need to adjust trim settings for the ASC-2400 to be more balanced.

Forward/Backward Trim

• If your ASC-2400 drifts forwards or backwards while in the air, counter the movement by using your forward /backward trim buttons (see diagram M).

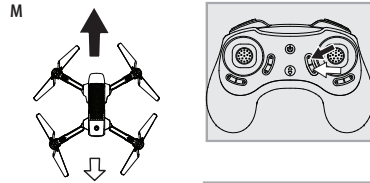

Bank Right/Left Trim

• If your ASC-2400 drifts to the left or right while in the air, counter the movement by using your left / right trim buttons (see diagram N).

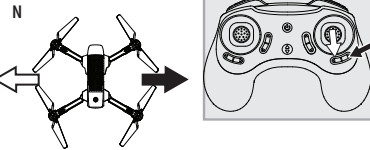

Spinning/Rotating Trim

• If your ASC-2400 spins either left or right while in the air, counter the rotation by using your left and right rotational trim buttons (see diagram O).

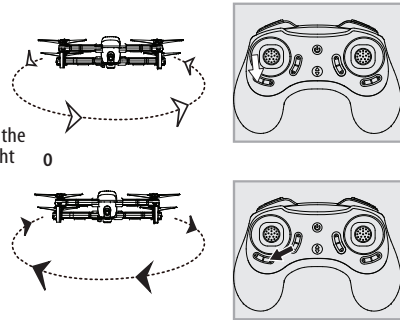

EMERGENCY STOP: press the “speed setting button” and “stunt button” simultaneously to stop the drone blade from spinning. Use this anytime you lose control of your drone.

NOTE: When using the trim buttons you will beeping sounds. A short “beep” indicates “one trim position movement” A long Beep indicates that you have reached the center trim position. When there are no longer beeps, you have reached the maximum trim position for that particular setting. If this happens and your Drone is still not stable, we suggest you re-sync your drone and re-calibrate on very flat surface (see recalibrating your drone on next page)

CALIBRATING THE ASC-2400

NOTE: Your ASC-2400 comes pre-calibrated out of the box so you are ready to fly.

After several crashes and shocks to your gyro sensors, you may notice that your drone is drifting and cannot hold its center position while hovering as well as it used to.

This most likely means that you need to recalibrate your ASC-2400. Please follow the simple instructions below.

1. Place the ASC-2400 on a very flat level surface.
2. Make sure the ASC-2400 is turned on and that the controller is synced (refer to syncing pg 4). Do not start the blades! Instead move both the throttle and control stick down and to the right hand bottom corner (see diagram P). If successful you will see the lights on the drone rapidly flash and stop. Once the lights stop flashing you have completed your calibration and are ready to fly again!

TROUBLE SHOOTING: If you do not see the lights flash, remove the battery from the drone then turn off your controller and start over. Always make sure to put your battery in before turning on your controller. Push the left throttle stick all the way up and then down touching the top and bottom of the controller. When you hear the beep the ASC-2400 is re-synced to the controller and you are ready to calibrate.

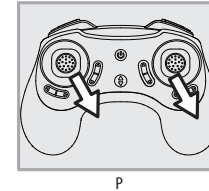

HOW TO PERFORM 360° STUNT ROLLS

Performing 360° stunt rolls with the ASC-2400 is as easy as 1-2-3:

1. Hover the ASC-2400 in a still position making sure that you have at least 6 feet of clearance above and below the drone. Set the speed settings to mode 2 or 3 (the ASC-2400 cannot perform the stunt roll in speed setting 1).
2. First press the 360 stunt button on the right top side of the controller and you will enter the “stunt roll mode” which is indicated by a rapid beeping sound (see diagram Q).
3. Next, using the right control stick, push directly to the right for a “right side roll” or directly to the left for a “left side roll” (see diagram R). Remember to always use caution when performing stunts.

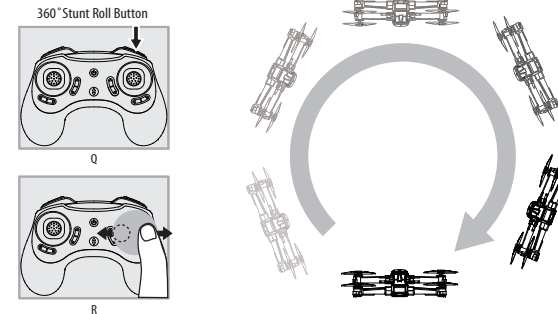

NOTE: To exit the stunt roll mode without flipping simply press the stunt button again and the beeping sound will stop indicating you have exited “stunt mode”

INSTALLING YOUR PHONE HOLDER

Installing your phone holder is required to use your ASC-2400 drone's camera. To install your phone holder, turn your controller around to the back side with the battery compartment facing you and start by clicking in the top "two teeth" into the two holes on the top of the controller and then proceed to click in the bottom (see diagram S).

To remove, pull from the bottom first.

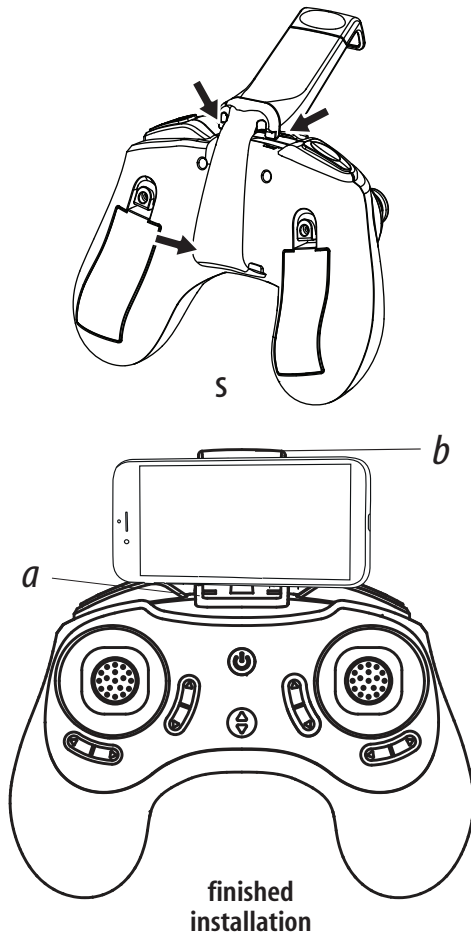

CAMERA VIDEO AND PHOTO STREAMING SETUP

Your ASC-2400 comes equipped with an on-board digital camera that takes both video and still photographs and streams them to your mobile device.

WHAT YOU WILL NEED TO GET STARTED USING YOUR CAMERA

1. One Apple or Android Smart phone* (Phone not included).
2. The ASC-2400 App successfully downloaded and installed on your mobile device.

Note instructions on using the App are in the application tutorial

3. To Download the ASC-2400 App, scan the appropriate QR code below which will link to the App on either the Android Play Store or Apple Store. If you are not able to scan the QR code, manually enter the web address located under the appropriate QR code for your phone.
4. After the ASC-2400 App is installed, it should create an icon on your screen (see icon below). Click the icon to run the App and make sure that it has installed correctly on your device. If not, please delete and repeat the process again.
5. Follow the "TUTORIAL" for instructions on connecting/pairing your ASC-2400 drone to the App and using the App for recording film and still photos.

ICON



2000 Series



Apple® iOS

http://netopsun.com/asc_2000_series_apple



Android OS

http://netopsun.com/asc_2000_series_google

* Apple® devices require the use of iOS 10.0 or higher.

ANDROID™ devices require the use of OS 4.2.2 or higher.

If you're still encountering difficulties downloading the ASC-2400 App, please contact our customer service department at www.amaxbrands.com or 1-866-360-1510

TROUBLESHOOTING YOUR ASC-2400

PROBLEM	POSSIBLE CAUSE	POSSIBLE SOLUTION
No Power	<ol style="list-style-type: none"> 1. Power switched off 2. Polarity is reversed 3. Batteries may be low or in need of charging 	<ol style="list-style-type: none"> 1. Press the ON/OFF switch to ON 2. Make sure all batteries are installed correctly (see diagram A) 3. Replace batteries
Drone Not Responding	<ol style="list-style-type: none"> 1. Remote is switched off 2. Battery power in remote is too weak 3. The remote is not properly synced 4. Out of control range 	<ol style="list-style-type: none"> 1. ASC-2400 the ON/OFF switch to ON 2. Replace remote batteries 3. Re-sync the remote 4. Do not fly beyond 400 feet
Drone Won't lift off	<ol style="list-style-type: none"> 1. Rotor speed too slow 2. Drone not fully charged 3. Obstruction of rotors 	<ol style="list-style-type: none"> 1. Push throttle lever forward 2. Recharge your ASC-2400 3. Check rotors for hair or other obstructions
Drone Spins, can not be trimmed	<p>Rotor deformation</p> <p>Motor not functioning</p>	<p>Replace the damaged rotor (You may need to consult with a customer service personnel)</p>
Drone Tilt to one direction	<p>Drone did not calibrate properly</p>	<p>Restart the drone and controller, properly calibrate it on a flat level surface</p>
Altitude Hold height is not stable, the drone continues to move up and down without locking into position	<p>Drone vibrates too much</p>	<p>Check the propeller deformation</p>

REPLACING THE PROPELLER BLADES

Your ASC-2400's propeller system is a precision instrument that may need repair or replacement from time to time for optimal flight function. Crash landing at high-speed may cause damage to your ASC-2400 propellers.

1. The ASC-2400 has four sets blades, two sets of blades with indication letters A & B on front, and two sets blades with indication letters B & A on the rear (see the diagram T).
2. When replacing the propeller blades, make sure to match the indication markings/letters on the blades.
3. Unscrew and take off the damaged blade.
4. Replace with new correct blade.

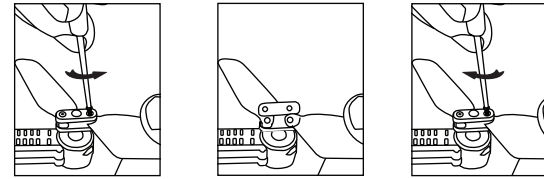

Blade Front Left = A
Blade Front Right = B

Blade Back Left = B
Blade Back Right = A

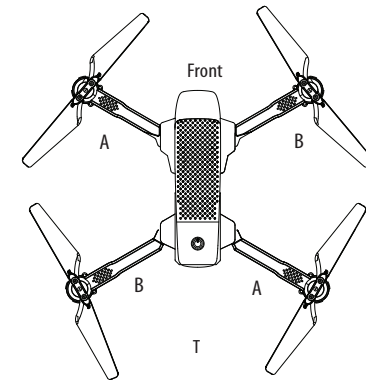

ASC-2400 WARNING:

The ASC-2400 is designed for OUTDOOR USE ONLY. The ASC-2400 blades revolve at high speeds and can cause damage to the user, spectators and animals. Stand away from the ASC-2400 to reduce the risk of getting into the flight path. Warn spectators that you will be flying your ASC-2400 so that they are aware of its position. Before flight, inspect the rotor blades to make certain that the blades are securely fastened to the ASC-2400.

WARNING!

- Choking/Cutting Hazard. Small Parts/Sharp Rotor Blades.
- Keep hands, hair and loose clothing away from the propeller when the power ASC-2400 is turned to the ON position.
- Turn off the transmitter and ASC-2400 when not in use.
- The included charger is built specifically for the ASC-2400 Li-Poly battery. Do not use it to charge any other battery.
- New alkaline batteries are recommended for maximum performance.
- Parental supervision recommended when flying ASC-2400.



BATTERY WARNINGS

RECHARGEABLE BATTERY:

This ASC-2400 uses a Li-Poly rechargeable battery. If battery no longer stays charged, dispose of battery properly according to local disposal requirements.

CONTROLLER BATTERIES:

Remote control requires 4 "AAA" batteries (included). Please read the important battery safety warning below.

- Do not mix alkaline, standard (carbon-zinc) and rechargeable batteries (Nickel Metal Hydride).
- Do not mix old and new batteries.
- Non-rechargeable batteries are not to be recharged.
- Rechargeable batteries are to be removed from the item before being charged (if removable).
- Rechargeable batteries are only to be charged under adult supervision.
- Exhausted batteries should be removed immediately and must be recycled or disposed of properly according to state or local government ordinances and regulations.
- The supply terminals are not to be short-circuited.
- Only batteries of the same or equivalent type as recommended are to be used.
- Batteries are to be inserted with the correct polarity (see inside booklet for diagram).
- Do not dispose batteries in a fire - batteries may leak or explode.
- This product is only to be connected to equipment bearing either of the following symbols:  or 

CARE AND MAINTENANCE

- Always remove the batteries from the wireless remote control when it is not being used for an extended period of time.
- To clean, gently wipe the remote control and ASC-2400 with a clean damp cloth.
- Keep the product away from direct heat or sunlight.
- Do not submerge the product into water. This can damage the unit beyond repair.
- Parental guidance recommended when installing or replacing the batteries.

Limited 90-Day Warranty

NORTH AMERICA

AMAX Group USA warrants to the original consumer that this product is free from any electrical or mechanical defects for a period of 90 DAYS from the date of purchase. If any such defect is discovered within the warranty period, AMAX Group USA will repair or replace the unit free of charge upon receipt of the unit, shipped postage prepaid and insured to our warranty center ALONG WITH THE ORIGINAL RECEIPT evidencing that the product was purchased from an approved AMAX retail partner and that the product is still within the 90 day warranty period. The warranty covers normal consumer use and does not cover damage that occurs in shipment or failure that results from alterations, accident, misuse, abuse, neglect, wear and tear, inadequate maintenance, commercial use or unreasonable use of the unit. Removal of any parts/components voids all warranties. This warranty does not cover cost of repairs made or attempted outside by third-party individuals or companies. Any applicable implied warranties, including warranties of merchantability and fitness, are hereby limited to 90 DAYS from the date of purchase. Consequential or incidental damages resulting from a breach of any applicable express or implied warranties are hereby excluded. Some states do not allow limitations on the duration of implied warranties and do not allow exclusion of incidental or consequential damages, so the above limitations and exclusions in these instances may not apply.

REPAIR/REPLACE PRODUCT

If your product begins to malfunction or stop working, immediately contact our warranty center (contact details listed below). If it is determined that a return is necessary, our warranty department will issue you an RMA number/form and an address to the nearest return center for shipping the product to us. When honoring the warranty, AMAX reserves the right to either repair, replace or refund the product.

IMPORTANT NOTICE:

We will reject and return to sender returns that are not accompanied by an AMAX issued RMA form and RMA number so make sure to contact our warranty center before attempting to return your product!

PREPARATION FOR SHIPPING YOUR PRODUCT:

Please repack your product in a durable box, preferably in the original carton, and send it prepaid, and adequately insured. Include the RMA form that was issued by our warranty department along with your daytime telephone number and email address inside the shipping carton. If your warranty has expired and you still require service please contact our customer care team. For further information please send all inquiries to: customer@amaxbrands.com

Our goods come with guarantees that cannot be excluded under the Australian Consumer Law. You are entitled to a replacement or refund for a major failure and for compensation for any other reasonably foreseeable loss or damage. You are also entitled to have the goods repaired or replaced if the goods fail to be of acceptable quality and the failure does not amount to a major failure.

IMPORTANT NOTICE!

DO NOT ATTEMPT TO SHIP YOUR PRODUCT BACK WITHOUT FIRST CONTACTING OUR WARRANTY DEPARTMENT AT:

www.amaxbrands.com

Email: care@amaxglobal.com

Phone 1-866-360-1510